

CP3921-0000
with
C9900-E274

main dimensions and
fixing points

dimensions in mm

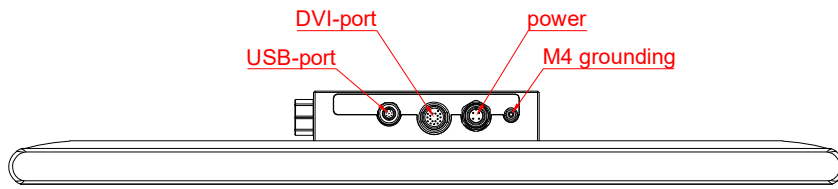
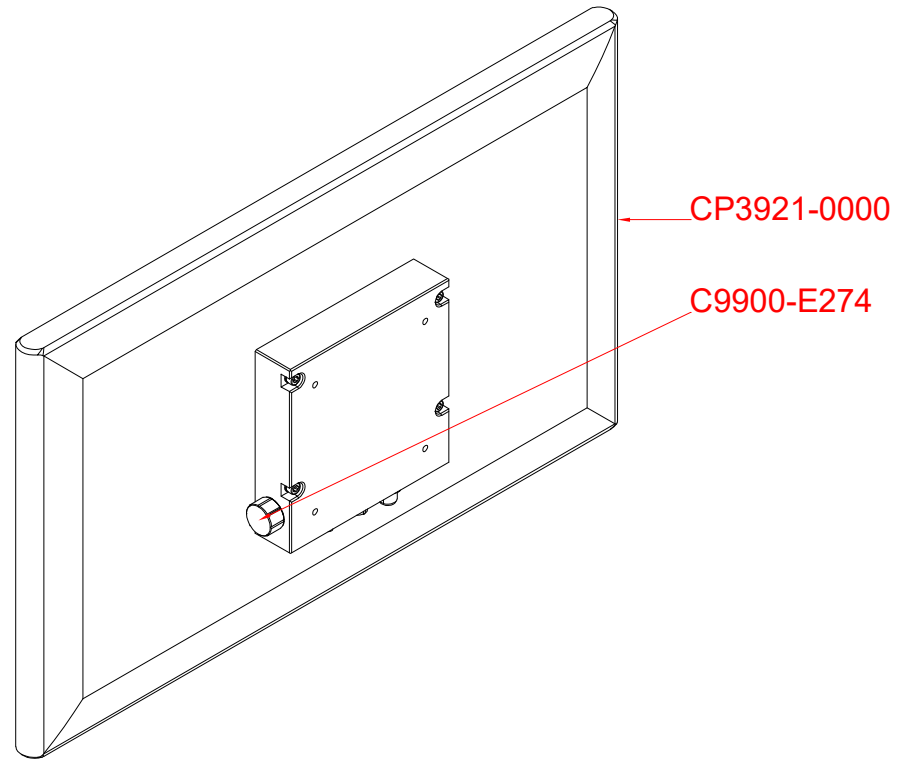

bottom view

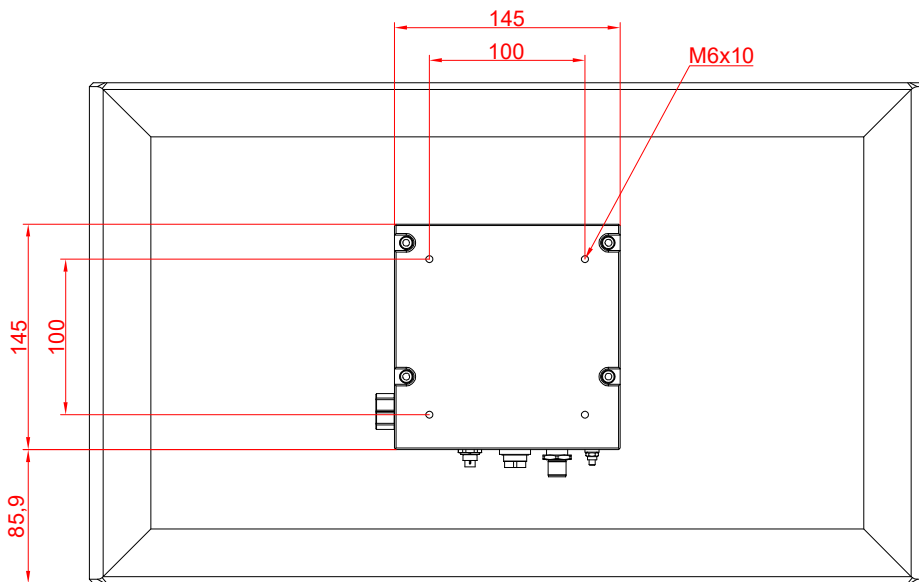

rear view

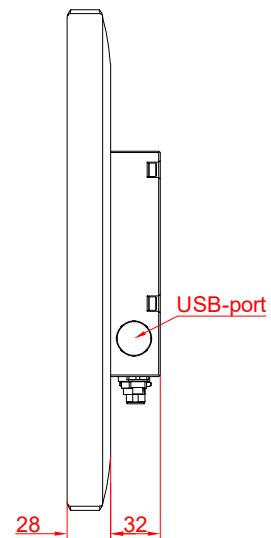

side view

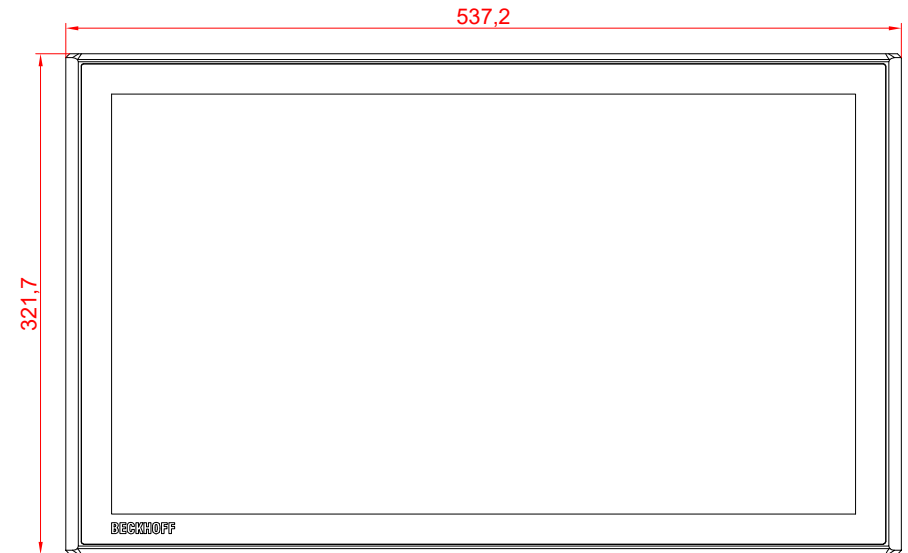

front view