

front view

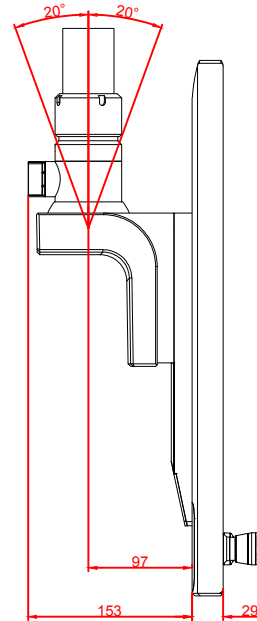

left view

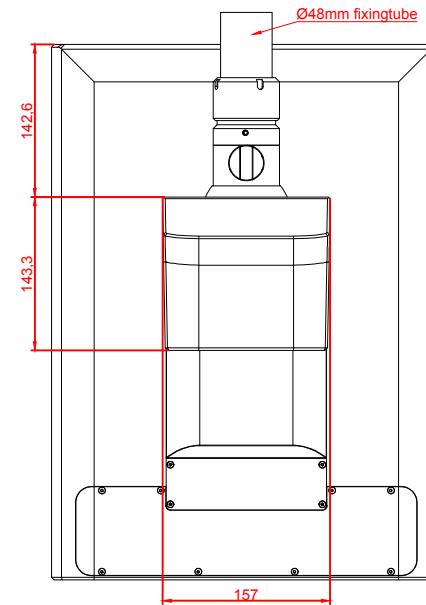

rear view

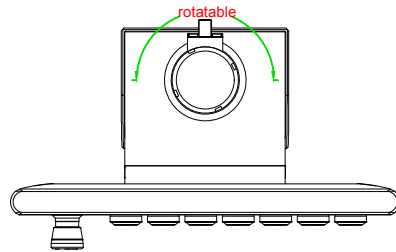

top view

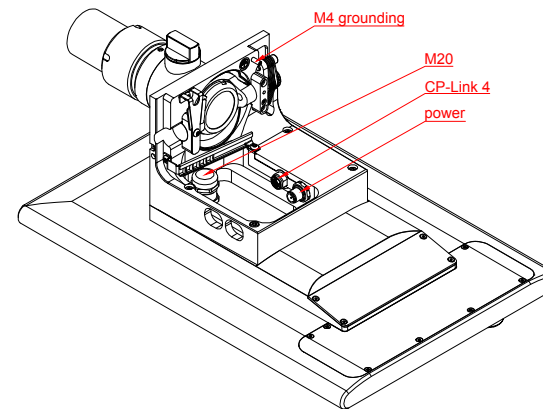

CP3919-G036-0010-M752

main dimensions and  
fixing points

dimensions in mm