

front view

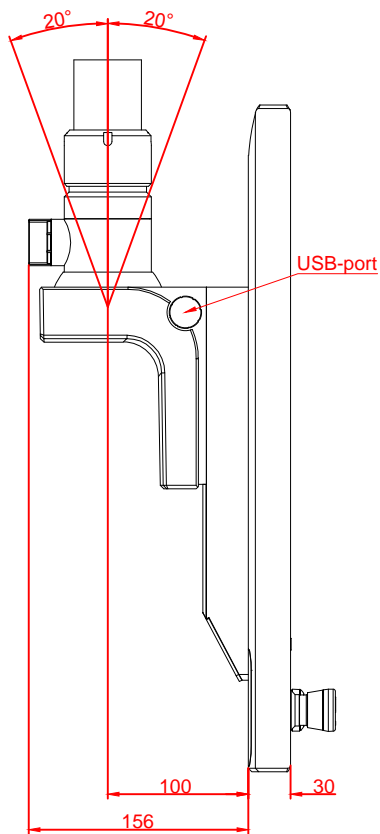

left view

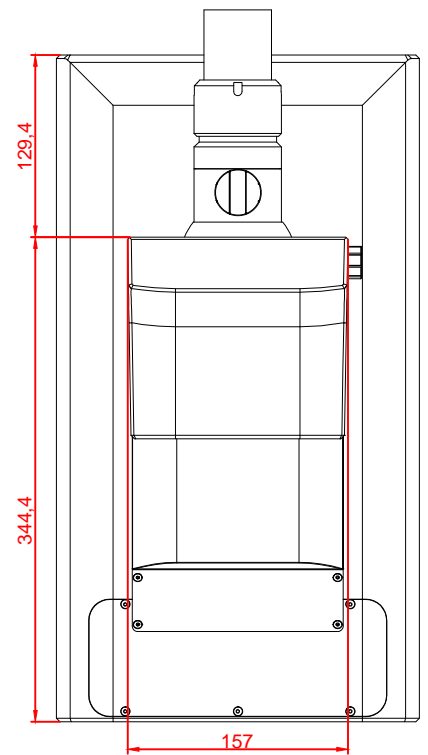

rear view

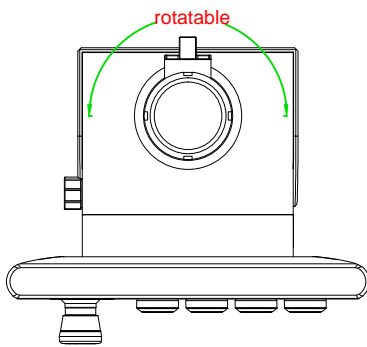

top view

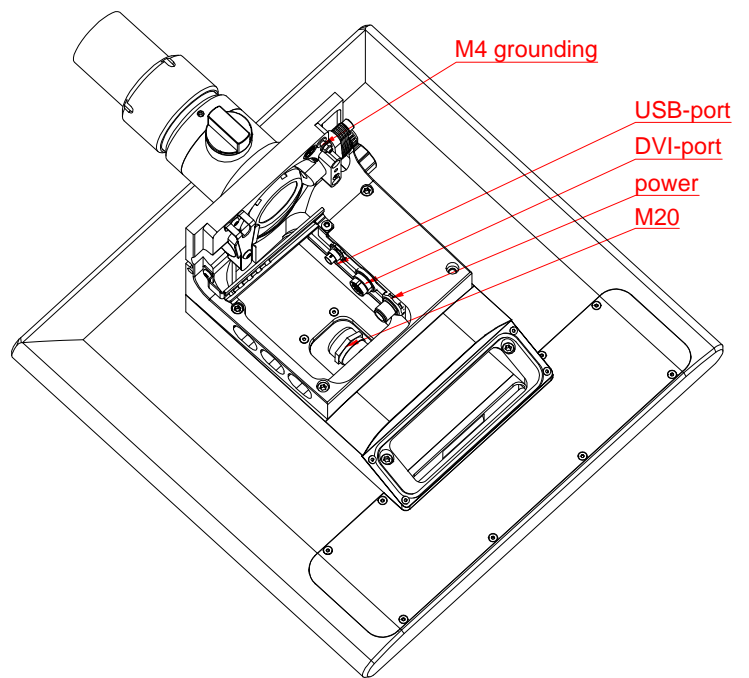

CP3916-M575-G034-M752-E274

main dimensions and
fixing points

dimensions in mm