

bottom view

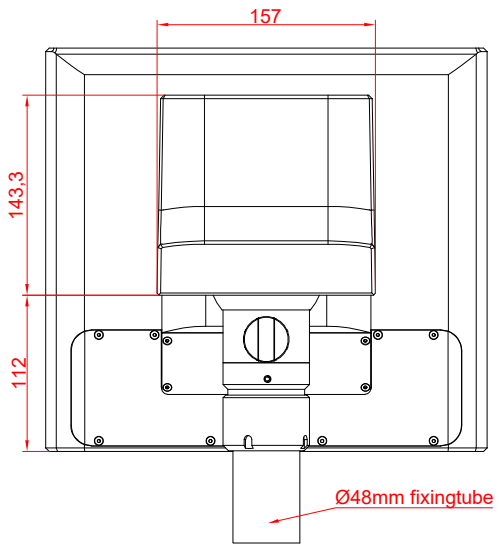

rear view

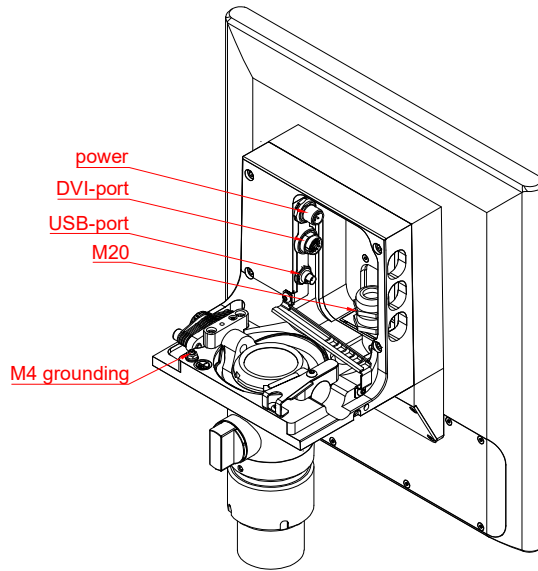
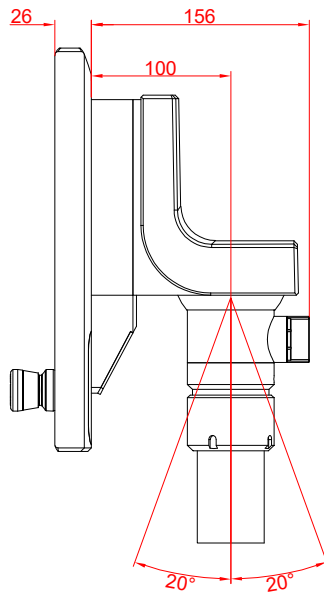

side view

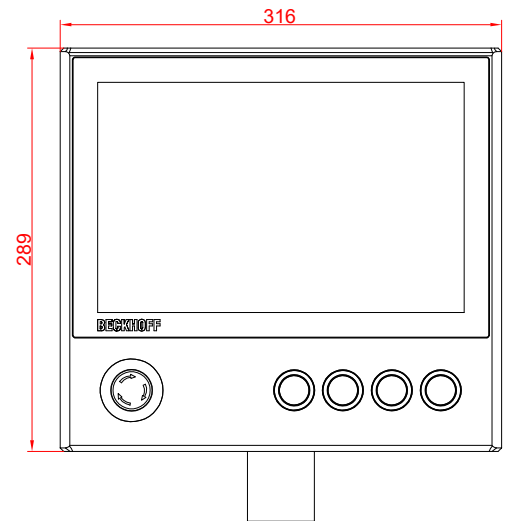

front view

CP3913-0000
with
C9900-G029
C9900-M753

main dimensions and
fixing points

dimensions in mm

