

# BECKHOFF New Automation Technology

Manual | EN

## C6905

Industrial PC





# Table of contents

<b>1</b>	<b>Notes on the documentation</b>	<b>5</b>
<b>2</b>	<b>For your safety</b>	<b>6</b>
2.1	Signal words	6
2.2	Intended use	6
2.3	Fundamental safety instructions	7
2.4	Operator's obligation to exercise diligence	7
2.5	Notes on information security	8
<b>3</b>	<b>Product overview</b>	<b>9</b>
3.1	Structure	10
3.2	Interface description	11
3.2.1	Power supply	11
3.2.2	Ethernet RJ45	12
3.2.3	USB	14
3.2.4	DVI	15
3.3	Status LEDs	16
3.4	Name plate	17
3.5	Seconds UPS	18
<b>4</b>	<b>Commissioning</b>	<b>19</b>
4.1	Transport and unpacking	19
4.2	Installation in the control cabinet	20
4.2.1	Dimensions	21
4.2.2	Installation in the control cabinet	22
4.3	Connecting the Industrial PC	23
4.3.1	Grounding of the Industrial PC	24
4.3.2	Connecting cables and power supply	25
4.4	Switching the Industrial PC on and off	26
<b>5</b>	<b>Beckhoff Device Manager</b>	<b>27</b>
<b>6</b>	<b>Decommissioning</b>	<b>29</b>
6.1	Disconnecting the power supply and cables	29
6.2	Disassembly and disposal	30
<b>7</b>	<b>Maintenance</b>	<b>31</b>
7.1	Cleaning	31
7.2	Maintenance	32
7.2.1	Access to device components	34
7.2.2	Replacing the battery	35
7.2.3	Replacing the storage media	35
<b>8</b>	<b>Troubleshooting</b>	<b>37</b>
<b>9</b>	<b>Technical data</b>	<b>38</b>
<b>10</b>	<b>Appendix</b>	<b>39</b>
10.1	Service and support	39
10.2	Approvals	40



# 1 Notes on the documentation

This description is intended exclusively for trained specialists in control and automation technology who are familiar with the applicable national standards.

For installation and commissioning of the components, it is absolutely necessary to observe the documentation and the following notes and explanations.

The qualified personnel is obliged to always use the currently valid documentation.

The responsible staff must ensure that the application or use of the products described satisfies all requirements for safety, including all the relevant laws, regulations, guidelines, and standards.

## Disclaimer

The documentation has been prepared with care. The products described are, however, constantly under development.

We reserve the right to revise and change the documentation at any time and without notice.

No claims to modify products that have already been supplied may be made on the basis of the data, diagrams, and descriptions in this documentation.

## Trademarks

Beckhoff®, TwinCAT®, TwinCAT/BSD®, TC/BSD®, EtherCAT®, EtherCAT G®, EtherCAT G10®, EtherCAT P®, Safety over EtherCAT®, TwinSAFE®, XFC®, XTS® and XPlanar® are registered and licensed trademarks of Beckhoff Automation GmbH.

If third parties make use of designations or trademarks used in this publication for their own purposes, this could infringe upon the rights of the owners of the said designations.

## Patents

The EtherCAT Technology is covered, including but not limited to the following patent applications and patents:

EP1590927, EP1789857, EP1456722, EP2137893, DE102015105702

and similar applications and registrations in several other countries.

## EtherCAT®

EtherCAT® is registered trademark and patented technology, licensed by Beckhoff Automation GmbH, Germany

## Copyright

© Beckhoff Automation GmbH & Co. KG, Germany.

The distribution and reproduction of this document as well as the use and communication of its contents without express authorization are prohibited.

Offenders will be held liable for the payment of damages. All rights reserved in the event that a patent, utility model, or design are registered.

## 2 For your safety

The signal words and their meanings are explained in the chapter on safety. They contain fundamental safety instructions that are essential for the avoidance of personal injuries and damage to property.

### Exclusion of liability

Beckhoff shall not be liable in the event of non-compliance with this documentation and thus the use of the devices outside the documented operating conditions.

## 2.1 Signal words

The signal words used in the documentation are classified below.

### Warning of personal injuries

<b>⚠ DANGER</b>
Hazard with high risk of death or serious injury.
<b>⚠ WARNING</b>
Hazard with medium risk of death or serious injury.
<b>⚠ CAUTION</b>
There is a low-risk hazard that can result in minor injury.

### Warning of property and environmental damage

<b>NOTICE</b>
There is a possibility of damage to the environment, equipment or data.

## 2.2 Intended use

The the Industrial PC is intended for use as a control system for automation, visualization and communication in machine and system engineering.

The device has been developed for an IP20 working environment. This involves finger protection and protection against solid foreign objects up to 12.5 mm. There is no protection against water. Operation of the devices in wet and dusty environments is not permitted.

The specified limits for technical data must be adhered to.

The device can be used within the documented operating conditions.

### Improper use

Do not use the device outside the documented operating conditions.

## 2.3 Fundamental safety instructions

The following safety instructions must be observed when handling the device.

### Application conditions

- Do not use the device under extreme environmental conditions.
- Only use the device in hazardous areas if it is explicitly designed for this purpose.
- Do not carry out any work on the device while it is live. Always switch off the supply voltage for the device before mounting it, replacing device components or rectifying malfunctions. This does not apply to the replacement of hard disks in a RAID configuration.
- Never plug or unplug connectors during thunderstorms. There is a risk of electric shock.
- Ensure that the device has a protective and functional earth connection.

### Damage to property, loss of data and impairment of functions

- If you change the hardware and software configurations, you must keep within the specified limits of power consumption and power loss (please refer to the respective data sheet).
- Ensure that only trained specialists with a control and automation engineering background, operate the device. Use by unauthorized persons can lead to damage to property and loss of data.
- In the case of a 24 V DC power supply unit, fuse the power supply line according to its cross-section to protect the supply line in the event of a short circuit.
- In case of fire, extinguish the device with powder or nitrogen.

## 2.4 Operator's obligation to exercise diligence

The operator must ensure that

- the products are used only for their intended purpose (see Chapter 2.2 [Intended use](#) [▶ 6]).
- the products are only operated in sound condition and in working order.
- the products are operated only by suitably qualified and authorized personnel.
- the personnel is instructed regularly about relevant occupational safety and environmental protection aspects, and is familiar with the operating instructions and in particular the safety instructions contained herein.
- the operating instructions are in good condition and complete, and always available for reference at the location where the products are used.

## 2.5 Notes on information security

The products of Beckhoff Automation GmbH & Co. KG (Beckhoff), insofar as they can be accessed online, are equipped with security functions that support the secure operation of plants, systems, machines and networks. Despite the security functions, the creation, implementation and constant updating of a holistic security concept for the operation are necessary to protect the respective plant, system, machine and networks against cyber threats. The products sold by Beckhoff are only part of the overall security concept. The customer is responsible for preventing unauthorized access by third parties to its equipment, systems, machines and networks. The latter should be connected to the corporate network or the Internet only if appropriate protective measures have been set up.

In addition, the recommendations from Beckhoff regarding appropriate protective measures should be observed. Further information regarding information security and industrial security can be found in our <https://www.beckhoff.com/secguide>.

Beckhoff products and solutions undergo continuous further development. This also applies to security functions. In light of this continuous further development, Beckhoff expressly recommends that the products are kept up to date at all times and that updates are installed for the products once they have been made available. Using outdated or unsupported product versions can increase the risk of cyber threats.

To stay informed about information security for Beckhoff products, subscribe to the RSS feed at <https://www.beckhoff.com/secinfo>.



### 3 Product overview

The C6905 Industrial PC belongs to the series of compact Industrial PCs for space-saving control cabinet installation. The device is suitable for various applications and requirements.

Thanks to the available processors, the Industrial PC can be used for the following applications, among others:

- diverse automation and visualization tasks
- wide range of IoT tasks, for example when used as an IoT gateway
- simple HMI applications
- axis control
- short cycle times
- high-volume data handling

The basic configuration of the C6905 includes the following aspects:

- Intel® processor
- 1 DVI connection, graphic adapter integrated in the Intel® processor
- 2 x 100/1000BASE-T connections, on-board dual Ethernet adapter
- CFast
- 4 x USB

### 3.1 Structure

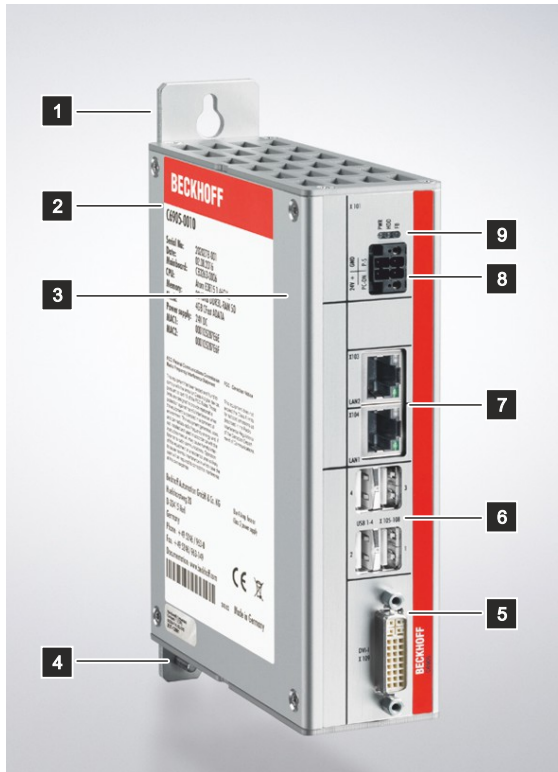

Fig. 1: Structure

Table 1: Key: C6905 structure

No.	Component	Description
1	Mounting plate	Plate for mounting the Industrial PC by its the rear side in the control cabinet
2	Name plate	Information on the equipment of the Industrial PC
3	Side cover	Access to battery and storage media
4	Protective conductor connection PE	Low-resistance protective earthing and functional earthing of the Industrial PC
5	DVI interface (X109)	Connection of a DVI-capable monitor
6	USB interfaces (X105 - X108)	Connection of peripheral devices
7	Ethernet RJ45 interfaces (X103, X104)	Connection of the Industrial PC to a 100/1000BASE-T network
8	Power supply (X101)	Connection of the power supply and external wiring of the Industrial PC
9	Status LEDs	Status display for power, hard disk, fieldbus

## 3.2 Interface description

In the basic equipment version, the C6905 includes the following interfaces:

- Power supply (X101)
- Ethernet RJ45 (X103, X104)
- USB (X105 - X108)
- DVI (X109)

### 3.2.1 Power supply

The industrial PC is supplied with a nominal voltage of 24 V. The 2x2-pin voltage socket (X101) is used for connection to the power supply and the external wiring of the industrial PC. The main supply voltage is applied between PIN 3 (0 V) and PIN 4 (24 V) of the socket. If the industrial PC is equipped with an internal, capacitive 1-second UPS (uninterruptible power supply), this is also supplied by the voltage. The 1-second UPS does not serve to back-up the operating system. Further information can be found in chapter 3.5 Seconds UPS [► 18].

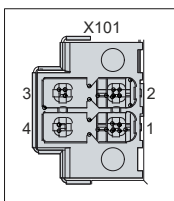

Fig. 2: Voltage socket pin numbering

Table 2: Voltage socket pin assignment

Pin	Signal	Description
1	PC-ON	Input PC-ON
2	P-S	Power status output
3	GND	0 V
4	24 V	Power supply

The plug for the power supply is specified for 8 A and can accommodate wire cross-sections of up to 1.5 mm<sup>2</sup>. For long supply lines, use 1.5 mm<sup>2</sup> cables to achieve a low voltage drop on the supply lines. There should be at least 22 V at the power supply plug of the industrial PC, so that the industrial PC remains switched on during voltage fluctuations. The plug is included in the delivery. You can obtain a replacement plug from your Beckhoff Sales using the following ordering option:

- C9900-P943: power supply connector for C6905 Industrial PC

### 3.2.2 Ethernet RJ45

The C6905 has two Gigabit LAN ports (X103, X104). The 100Base-T, 1000Base-T and 2500Base-T Ethernet standards enable the connection of corresponding network components and data rates of 100/1000/2500 Mbit/s. The required speed is selected automatically.

The RJ45 connection technology with twisted-pair cables is used. The maximum length of the cable connection is 100 m.

The controllers are used as follows, based on the device generations:

Table 3: Controller classification based on device generations

Generation	Controller	Mbit/s
C6905-0010	Intel® i210 for LAN1 and LAN2	100/1000
C6905-0020	Intel® i210 for LAN1 and LAN2	100/1000
C6905-0030	Intel® i226 for LAN1 and LAN2	100/1000/2500

The Ethernet port i210/i226 connected via PCIe is usually suitable for cycle times  $\leq 1$  ms and for distributed clock applications with EtherCAT.

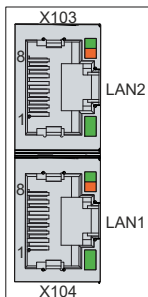

Fig. 3: Ethernet interfaces pin numbering

Table 4: Ethernet interface pin assignment

Pin	Signal	Description
1	T2 +	Pair 2
2	T2 -	
3	T3 +	Pair 3
4	T1 +	
5	T1 -	Pair 1
6	T3 -	
7	T4 +	Pair 4
8	T4 -	

The LEDs of the LAN interfaces indicate the activity and the data transmission rate (Mbit/s). The LED shown completely green in the figure indicates whether the interface is connected to a network. If this is the case, the LED lights up green. The LED flashes green when data transmission is in progress on the interface.

The green/orange LED shown in the figure indicates the data transmission rate. The device generations differ in terms of the possible speed. The following tables show the LED lighting according to the possible speed.

Table 5: LED lighting speed 100/1000 Mbit/s

Mbit/s	LED
100	Lights-up orange
1000	Lights up green

*Table 6: LED lighting speed 100/1000/2500 Mbit/s*

<b>Mbit/s</b>	<b>LED</b>
100	Off
1000	Lights-up orange
2500	Lights up green

### 3.2.3 USB

The industrial PC has four USB interfaces (X105-X108). They are used to connect peripheral devices with USB interfaces.

The following table shows the interface assignment based on the device generation:

Table 7: USB interfaces based on device generation

Generation	USB interfaces
C6905-0010	4x USB 2.0
C6905-0020	2x USB 3.0 2x USB 2.0
C6905-0030	2x USB 3.1 Gen. 2 2x USB 2.0

Each of the four USB interfaces supplies up to 500 mA current and is electronically fused.

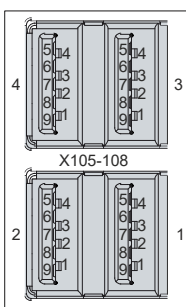

Fig. 4: USB interface pin numbering

Table 8: USB interface pin assignment

Pin	Connection
1	Vbus
2	D -
3	D +
4	GND
5	StdA_SSRX -
6	StdA_SSRX +
7	GND_DRAIN
8	StdA_SSTX -
9	StdA_SSTX +

For USB 2.0, only pins 1 to 4 are relevant.

### 3.2.4 DVI

The industrial PC has a DVI connection (X109), to which a DVI-capable monitor can be connected. Only digital signals are transmitted.

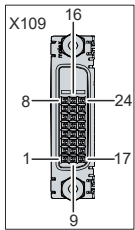

Fig. 5: DVI interface

Table 9: DVI interface pin assignment

Pin	Connection	Pin	Connection	Pin	Connection
1	TMDS Data 2 +	9	TMDS Data 1 -	17	TMDS Data 0 -
2	TMDS Data 2 +	10	TMDS Data 1 +	18	TMDS Data 0 +
3	TMDS Data 2/4 Shield	11	TMDS Data 1/3 Shield	19	TMDS Data 0/5 Shield
4	not connected	12	not connected	20	not connected
5	not connected	13	not connected	21	not connected
6	DDC Clock	14	+ 5 V Power	22	TMDS Clock Shield
7	DDC Data	15	Ground (+ 5 V, Analog H/V Sync)	23	TMDS Clock +
8	Analog Vertical Sync	16	Hot Plug Detect	24	TMDS Clock -

### 3.3 Status LEDs

The industrial PC has three status LEDs: PWR, FB, HDD. They provide information on the following aspects:

- the status of the power controller
- the fieldbus status
- the hard disk activity

The figure shows where the LEDs are located on the industrial PC.

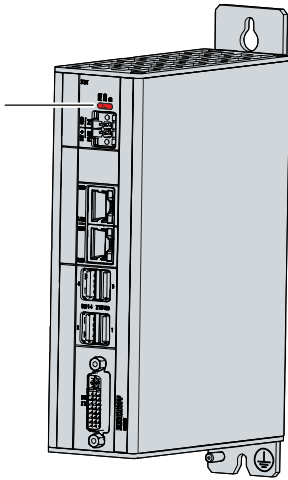

Fig. 6: Status LEDs

Table 10: Meaning of the Status LEDs

LED	Color/flashing interval	Meaning
PWR (Power)	green	Computer on
	off	Computer off
FB (fieldbus)	red	TwinCAT Stop
	blue	TwinCAT Config
	blue/red flashing	TwinCAT Config (fieldbus error)
	green	TwinCAT Run
	green/red flashing	TwinCAT Run (fieldbus error)
HDD (hard disk)	red	Accessing storage media



### 3.4 Name plate

The name plate provides information on the equipment fitted to the industrial PC. The name plate shown here serves only as an example.

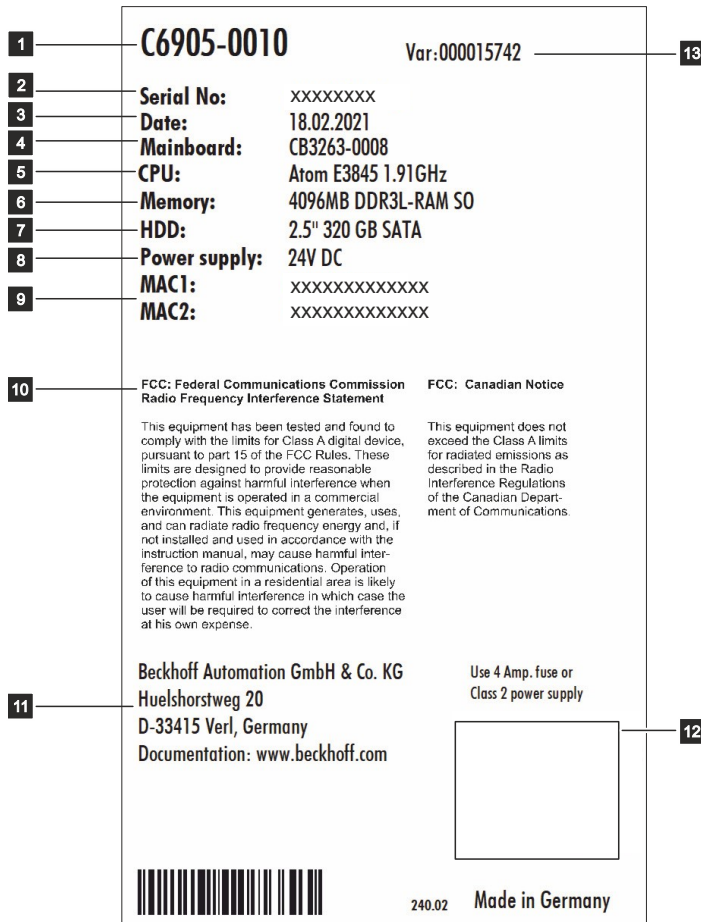



Fig. 7: Name plate example

Table 11: Key: name plate C6905

No.	Description
1	Model: The last four digits indicate the device generation.
2	Serial number (BTN)
3	Date of manufacture
4	Mainboard
5	CPU
6	RAM
7	Storage media
8	Power supply unit: 24 V <sub>DC</sub>
9	MAC addresses of the Ethernet interfaces (X103, X104)
10	FCC approval
11	Address of the vendor
12	Symbols  <div style="text-align: right;">  </div> Note: Here are the symbols applicable to the device such as CE, EAC, UKCA,  . The approvals of your device can be found on the name plate and in chapter 10.2 Approvals.
13	Variant number: Commercial number of the order code including ordering options

### 3.5 Seconds UPS

#### NOTICE

##### Loss of data

Using the seconds UPS beyond the documented possibilities can lead to data loss or corrupt data.

- Use only TwinCAT to control the seconds UPS and save only persistent data with a maximum size of 1 MB.

There is an option to order the industrial PC with an internal uninterruptible power supply (UPS). This is a capacitive seconds UPS for the reliable saving of persistent application data on the storage medium. This requires TwinCAT and Windows Embedded Compact 7, Windows Embedded Standard 7 or Windows IoT Enterprise.

You can order the industrial PC with internal UPS ex factory by specifying the order identifier C9900-U214.

The capacitive seconds UPS continues to supply the processor with power if the power supply fails. During this time, the persistent data can be stored on the storage medium and will be available when the device is turned on again. The UPS only works for a few seconds.

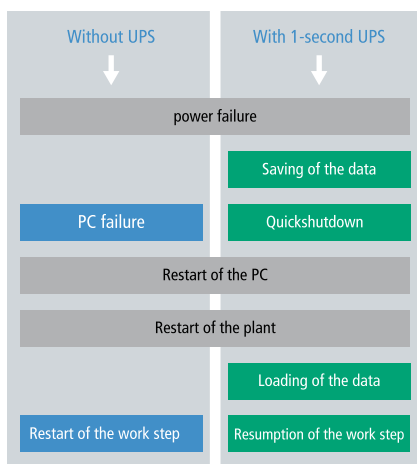

Fig. 8: UPS function

The UPS can be controlled from the PLC with the function block FB\_S\_UPS\_BAPI. For more information, please visit the Beckhoff Information System at the following link: [https://infosys.beckhoff.com/english.php?content=../content/1033/tcplclib\\_tc2\\_sup/3716524299.html&id=7162402166301276776](https://infosys.beckhoff.com/english.php?content=../content/1033/tcplclib_tc2_sup/3716524299.html&id=7162402166301276776)

## 4 Commissioning

To be able to use the Industrial PC, you must first commission it. The first step is to transport the device to its operating location and unpack it. This is followed by installing the device in the control cabinet, connecting the cables and the power supply and finally switching on the Industrial PC.

### 4.1 Transport and unpacking

Note the specified transport and storage conditions (see Chapter 9 [Technical data](#) [▶ 38]).

Despite the robust design of the unit, the components are sensitive to strong vibrations and impacts. During transport the device must therefore be protected from mechanical stress. Appropriate packaging of the device, such as the original packaging, can improve the vibration resistance during transport.

#### NOTICE

##### Hardware damage due to condensation

Unfavorable weather conditions during transport can cause damage to the device.

- Protect the device against moisture (condensation) during transport in cold weather or in case of extreme temperature fluctuations.
- Do not put the device into operation until it has slowly adjusted to the room temperature.
- Should condensation occur, wait for about 12 hours before switching the device on.

##### Unpacking

Proceed as follows to unpack the unit:

1. Remove packaging.
2. Keep the packaging for possible future transport.
3. Check your delivery for completeness by comparing it with your order.
4. Check the contents for visible shipping damage.
5. In case of discrepancies between the package contents and the order, or in case of transport damage, please inform Beckhoff Service (see Chapter 10.1 Service and support).

## 4.2 Installation in the control cabinet

### NOTICE

#### Incorrect installation

Mounting the device in a way that deviates from the documentation can impair its functionality.

- Mount the device only in the orientations shown in the documents.

The C6905 Industrial PC is designed for mounting in control cabinets in machine and plant engineering applications. Please observe the environmental conditions prescribed for the operation (see Chapter 9 [Technical data](#) [▶ 38]).

With the standard mounting plate, you can mount the industrial PC in the control cabinet via the rear panel (see Chapter 4.2.2 [Installation in the control cabinet](#) [▶ 22]). The industrial PC is automatically delivered with the mounting plate already mounted (see fig. 9).

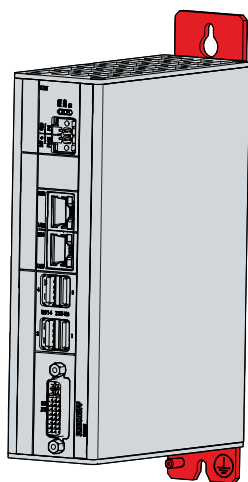

Fig. 9: Mounting plate

### 4.2.1 Dimensions

The dimensions of the Industrial PC and the mounting plate are used to prepare the control cabinet and to mount the device correctly in the control cabinet.

All dimensions are in mm.

Figure 10 illustrates the dimensions of the industrial PC with the standard mounting plate.

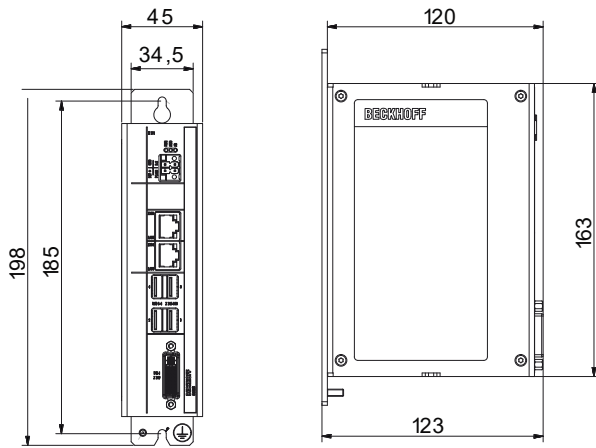

Fig. 10: Dimensions standard mounting plate

## 4.2.2 Installation in the control cabinet

### NOTICE

#### Extreme environmental conditions

Extreme environmental conditions can cause damage to the device.

- Avoid extreme environmental conditions.
- Protect the device against dust, moisture and heat.
- Do not cover the device's ventilation grille.

When installing in the control cabinet, note that there must be 5 cm of free space above and below the device for ventilation.

#### Mounting via mounting plates

In order to mount the Industrial PC with the standard mounting plate in the control cabinet, it must be furnished with the holes for the fastening screws according to the dimensions of the PC (see Chapter 4.2.1 [Dimensions](#) [▶ 21]). You need M4 screws for mounting.

After you have drilled the holes for the fastening screws in the control cabinet, you can mount the Industrial PC in the control cabinet with mounting plate.

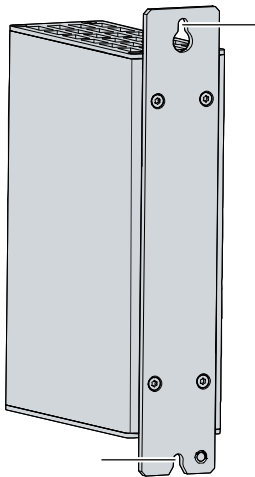

Fig. 11: Control cabinet installation

To install the industrial PC in the control cabinet, follow the steps below:

1. Place the fastening screws in the drill holes in the rear panel of the control cabinet.
  2. Hang the PC on the screws at the marked points of the mounting plate (see Fig. 11).
  3. Tighten the fastening screws.
- ⇒ You have successfully installed the industrial PC in the control cabinet.

## 4.3 Connecting the Industrial PC

### ⚠ CAUTION

#### **Risk of electric shock**

Dangerous touch voltages can lead to electric shock. To avoid electric shock, observe the following:

- Never connect or disconnect the device cables during a thunderstorm.
- Provide protective earthing for handling the device.

To prepare the industrial PC for operation, it must be connected. The first step is to ground the device. Then you can connect the cables and the power supply.

Wire the industrial PC in the control cabinet in accordance with the EN 60204-1:2006 standard on Protective Extra Low Voltage (PELV) so that one side of the circuit or a point on the power source of this circuit is connected to the protective conductor system.

### 4.3.1 Grounding of the Industrial PC

Potential differences are minimized and electrical currents are diverted to the ground through grounding or potential equalization of electronic devices. This is to prevent dangerous touch voltages and electromagnetic interference.

At the lower end of the Industrial PC mounting plate is the protective connector PE (see also chapter 3.1 [Structure \[► 10\]](#)), via which both the protective earth of the PC and the functional earth can be connected. Therefore, use cables with a cross-section of at least 4 mm<sup>2</sup> for the connection of the protective conductor.

#### Protective earth

By connecting the PE protective conductor connection to the central grounding point of the control cabinet panel in which the PC is installed, you establish low-resistance protective earthing of the Industrial PC and thus avoid dangerous touch voltages.

#### EMC

#### NOTICE

##### Hardware damage due to electromagnetic interference

Using the Industrial PC without functional earthing can lead to hardware damage due to electromagnetic interference.

- Only use the device with functional earthing.

Electromagnetic compatibility (EMC) of the industrial PC includes on the one hand not affecting other devices and equipment by electromagnetic interference and on the other hand not being disturbed by electrical or electromagnetic effects itself.

For this purpose, the Industrial PC must comply with certain protection requirements. The Industrial PC has EMC interference immunity according to EN 61000-6-2. The EMC interference emission of the device meets the requirements of EN 61000-6-4.

The functional earth is necessary for the EMC of the device. The functional earth is established by connecting the grounding point on the PC mounting plate to the central grounding point of the control cabinet in which the PC is installed.



## 4.3.2 Connecting cables and power supply

### NOTICE

#### Incorrect connection procedure

Incorrect procedure when connecting the cables and the power supply can cause hardware damage.

- Follow the documented procedure for connecting the cables and the power supply.
- Always connect the cables first and only then switch on the power supply.
- Please read the documentation for the external devices prior to connecting them.

#### Connecting cables

The connections are located in the front of the industrial PC and are documented in Chapter 3.1 [Structure](#) [► 10].

Make sure that you first ground the PC (see chapter [Grounding of the Industrial PC](#) [► 24]) and then plug in all data transmission cables.

#### Connecting the power supply

Cables with a maximum cable cross-section of 1.5 mm<sup>2</sup> must be used for connecting the power supply. To achieve the lowest possible voltage drop on the supply line, we recommend connecting the maximum possible cross-section. In case of larger distances between the power source and the PC, take into account the voltage drop in relation to the cable cross-section as well as fluctuations in your supply voltage in order to ensure that the voltage at the power supply unit does not fall below 22 V.

Proceed as follows to connect the 24 V<sub>DC</sub> power supply unit:

1. Check the correct voltage of your external power supply.
2. Install the power cable.
3. Plug the power cable into the voltage socket of the industrial PC.
4. Screw the power cable to the voltage socket of the industrial PC.
5. Connect the PC to your external 24 V power supply.
6. Switch on the 24 V power supply.

## 4.4 Switching the Industrial PC on and off

### NOTICE

#### Public networks

Connecting the PC to public networks without additional protective measures can compromise the safety of the device.

- Protect the PC before connecting it to public networks.

### NOTICE

#### Data loss due to switching off the PC while the software is running

Switching off the PC before the running software is terminated and the operating system is shut down can lead to data loss.

- Quit the running software and shut down the operating system before switching off the PC.

The industrial PC is started or switched off when the system is switched on or off or when the power supply to the PC is connected or disconnected.

You can use the PC-ON input of the PC to control the startup and shutdown of the operating system. The PC-ON signal is inverted, which is why the operating system boots up at 0 V at the input and shuts down at 24 V. During operation, 0 V must therefore be permanently applied to the input. If you want to shut down the operating system, you must apply 24 V to the PC-ON input. Once the operating system has shut down, the PC power supply unit sets the Power Status output from 24 V to 0 V. This indicates that the shutdown is complete. You can then switch off the power supply. If you remove the 24 V from the PC-ON input before you have switched off the power supply, the operating system restarts. Therefore, 24 V must be applied to the PC-ON input until you have switched off the power supply.

To shut down the operating system properly, you can install an additional ON/OFF switch next to the machine's main switch to turn the machine on and off. The main switch can thus remain switched on in principle and thus ensures that the PC is still supplied with power during the shutdown of the operating system. Via the Power Status output, you can switch, for example, a contactor that switches off the entire system. The load capacity of the Power Status output is limited to max. 0.5 A. No fuse protection is required.

#### Driver installation

When you switch on the PC for the first time, the optionally pre-installed operating system will be started. For any additional hardware you have connected, you have to install the drivers yourself afterwards. In addition, the Beckhoff Device Manager starts automatically. The Device Manager is a software from Beckhoff that supports you in configuring the PC.

If you have ordered the PC without an operating system, you must install this and the driver software for the additional hardware you have connected and for the devices in the PC yourself. Please follow the instructions in the documentation for the operating system and the additional devices.

## 5 Beckhoff Device Manager

The Beckhoff Device Manager enables detailed system diagnostics with uniform secure access to the existing hardware and software components. System data is recorded, analyzed and evaluated during operation. The data helps to detect deviations at an early stage and prevent PC downtime.

The Beckhoff Device Manager always starts automatically after the industrial PC has been booted. In addition, you have the option of manually starting the previously closed Device Manager at any time.

The industrial PC is delivered with predefined access data as standard:

- User name: Administrator
- Password: 1

You also have the option of using the Beckhoff Device Manager to remotely configure the industrial PC via a web browser. More detailed information is available in the Beckhoff Device Manager [manual](#).

### First start Beckhoff Device Manager

When your industrial PC is booted for the first time, the Beckhoff Device Manager also starts automatically for the first time. The Security Wizard opens. This tells you that you should reset the default password set by Beckhoff. Proceed as follows:

1. Click **Next** on the Security Wizard start page.  
⇒ This will take you to the **Change Passwords** page:

BECKHOFF Device Manager

**Change Passwords**

Your Beckhoff IPC is delivered with default user accounts and related default passwords! It is strongly recommended to change the default passwords to prohibit unauthorized access to your Beckhoff IPC. Please note that these passwords are valid for the access to the Beckhoff Device Manager, too.

Change the default password of the user account(s) to prohibit unauthorized access to your Beckhoff IPC.

Local Users: Administrator

Password: [input field]

New Password: [input field]

New Password (confirm): [input field]

Auto Logon Enabled:

<< Back Next >>

Fig. 12: Beckhoff Device Manager - Change passwords

2. Enter the access data of the Device Manager on delivery.
3. Choose a secure new password. Instructions for choosing a secure password are given below.
4. Confirm the changes by clicking on the tick in the red box on the right.
5. Exit the Security Wizard.  
⇒ You have reached the Device Manager start page.

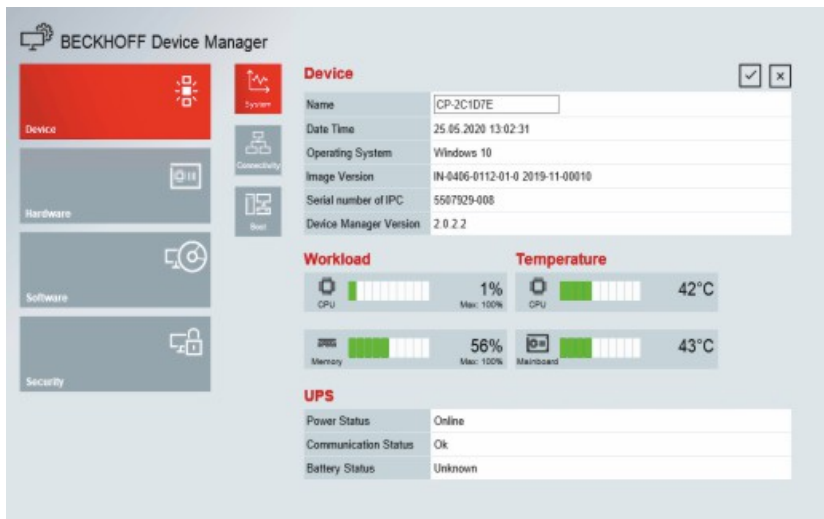

Fig. 13: Beckhoff Device Manager – Start page

Navigate forward in the menu and configure the industrial PC. Note that modifications only become active once they have been confirmed.

### Manual start Beckhoff Device Manager

To start the Beckhoff Device Manager manually, proceed as follows:

1. Open a web browser locally on the industrial PC.
2. Enter *localhost/config* in the web browser to start the Beckhoff Device Manager.

The Beckhoff Device Manager starts. The Security Wizard appears.

### Secure passwords

Strong passwords are an important prerequisite for a secure system.

Beckhoff supplies the device images with standard user names and standard passwords for the operating system. It is imperative that you change these.

Controllers are shipped without a password in the UEFI/BIOS setup. Beckhoff recommends assigning a password here as well.

Please note the following:

- Passwords should be unique for each user and service.
- Only change passwords after an incident in which passwords have become known without authorization.
- Train the device users in the use of passwords.

A secure password has the following characteristics:

- Password complexity: The password should contain capital and lower-case letters, numbers, punctuation marks and special characters.
- Password length: The password should be at least 10 characters long.

## 6 Decommissioning

### NOTICE

#### Hardware damage due to power supply

A connected power supply can cause damage to the device during disassembly.

- Disconnect the power supply from the device before starting to disassemble it.

When taking the industrial PC out of operation, you must first disconnect the power supply and cables. You can then remove the device from the control cabinet.

If you do not want to continue using the industrial PC, Chapter 6.2 [Disassembly and disposal](#) [► 30] provides information on the correct disposal of the device.

### 6.1 Disconnecting the power supply and cables

#### ⚠ CAUTION

#### Risk of electric shock

Dangerous touch voltages can lead to electric shock. To avoid electric shock, observe the following:

- Never connect or disconnect the device cables during a thunderstorm.
- Provide protective earthing for handling the device.

Before you remove the industrial PC from the control cabinet, you must disconnect the cables and the power supply. Follow the steps below:

1. Shut down the operating system.
  2. Disconnect the PC from your external 24 V power supply.
  3. Unscrew the voltage connector and pull it out of the PC.
  4. Remove the power supply cable if the connector is to remain with the PC.
  5. Make a note of the wiring of all data transmission cables if you want to restore the cabling with another device.
  6. Disconnect the data transmission cables from the industrial PC.
  7. Finally, disconnect the grounding strap.
- ⇒ You have disconnected the cables and the power supply.

## 6.2 Disassembly and disposal

Before you can remove the industrial PC from the control cabinet, you must first disconnect the power supply and the cables (see chapter 6.1 [Disconnecting the power supply and cables](#) [▶ 29]).

### Disassembly with mounting plates

Proceed as follows to remove the industrial PC with the corresponding mounting plate from the control cabinet:

1. Loosen the fastening screws just enough so that they remain attached to the control cabinet.
  2. Lift the PC far enough so that the fastening screws slip into the keyholes (see fig. 14).
  3. Remove the PC from the control cabinet.
- ⇒ You have successfully disassembled the PC.

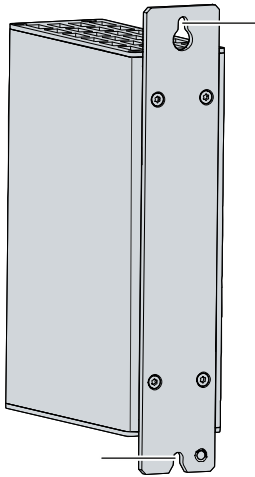

Fig. 14: Dismantling the control cabinet

### Disposal of the industrial PC

Be sure to observe the national electronic scrap regulations when disposing of the industrial PC.

In order to dispose of the device, it must be removed and fully dismantled. Dispose of the components in the following way:

- Send plastic parts (polycarbonate, polyamide (PA6.6)) for plastics recycling.
- Take metal parts to the metal recycling collection point.
- Electronic parts such as fans and circuit boards must be disposed of in accordance with national electronic scrap regulations.
- Stick insulating tape over the poles of the CR2032 battery on the motherboard and dispose of the battery via the local battery recycling.

## 7 Maintenance

### ⚠ CAUTION

#### Risk of electric shock

Working on the device when live can lead to electric shock.

- Switch off the power supply before replacing device components. Excluded from this is the replacement of hard disks and SSDs in RAID configuration as well as fan cartridges.

Maintenance measures increase the efficiency of the device by ensuring long-term functionality. Cleaning and maintenance by replacing certain device components contribute to this.

#### Repair

Only the vendor may repair the device. If a repair should be necessary, contact Beckhoff Service (see Chapter 10.1 [Service and Support](#) [▶ 39]).

## 7.1 Cleaning

### NOTICE

#### Unsuitable cleaning agents

The use of unsuitable cleaning agents can damage the device.

- Clean the device only as specified.

It is essential to observe the following aspects when cleaning the industrial PC:

- Make sure that no dust gets into the PC.
- Always keep the ventilation grilles free.
- Only use a vacuum cleaner to clean the PC. The industrial PC does not have to be switched off for this.
- Never use compressed air to clean the PC.

## 7.2 Maintenance

### NOTICE

#### Use of incorrect spare parts

The use of spare parts not ordered from Beckhoff Service can lead to unsafe and faulty operation.

- Only use spare parts that you have ordered from Beckhoff Service.

Beckhoff devices are manufactured from components of the highest quality and robustness. They are selected and tested for best interoperability, long-term availability and reliable function under the specified environmental conditions.

Nevertheless, some components of the devices may be subject to a limited service life if they are operated under certain conditions, such as at increased ambient temperatures during operation or during storage or during long periods of storage out of operation.

Beckhoff therefore recommends replacing some of the components of the devices after the time after which predictions of the remaining service life of such components can no longer be reliably calculated.

These are the following components:

- Battery
- Storage media

The following table provides recommendations for the regular, precautionary replacement of the device components:

Table 12: Device component replacement recommendations

Component	Recommendation for replacement intervals (years)
UPS battery pack	5 years
2.5-inch hard disk	5 years or after 20,000 operating hours at more than 40 °C or after 30,000 operating hours at less than 40 °C
3.5-inch hard disk	5 years, irrespective of the operating hours
Fan	7 years
Compact Flash, CFast or SSD	10 years
Motherboard battery	5 years

Beckhoff is excluded from liability in the event of possible damage occurring during maintenance work. In order to avoid damage caused by electrostatic discharge when replacing device components, protective measures are recommended. Below are some suggestions.

### ESD protection

### NOTICE

#### Electrostatic discharge

The replacement of device components without ESD protection can lead to functional impairment and destruction of the device.

- If possible, apply ESD protection measures during maintenance work.

When working on electronic devices, there is a risk of damage due to ESD (electrostatic discharge), which can impair the function or destroy the device.

Protect the device and create an ESD-protected environment in which existing electrostatic charges are safely discharged to ground and charging is prevented.

An ESD-protected environment can best be created by setting up ESD protection zones. The following measures serve this purpose:

- ESD-compliant floors with sufficient conductivity to the reference potential PE;
- ESD-compatible work surfaces such as tables and shelves;



- Wrist grounding strap, especially for sedentary activities;
- grounded and electrostatically dissipating equipment and operating materials (e.g. tools) within the ESD protection zone.

If it is not possible to create an ESD protection zone, you can still protect the device against ESD damage. For example, the following measures can be used:

- Use conductive mats connected to the ground potential as underlays.
- Dissipate possible charges from your own body by touching grounded metal (e.g. control cabinet door).
- Wear a wrist grounding strap.
- Only remove new electronic components from the ESD packaging (tinted plastic bag) after putting on the wrist grounding strap.
- Do not walk around with electronic components in your hand if they are not in ESD packaging.

## 7.2.1 Access to device components

In order to be able to replace certain device components, you must first gain access to these components.

### Access to battery and CFast

You can access the battery and the CFast via the cover on the left-hand side. To do this, remove the four Torx TX10 screws and remove the cover (see fig. 15).

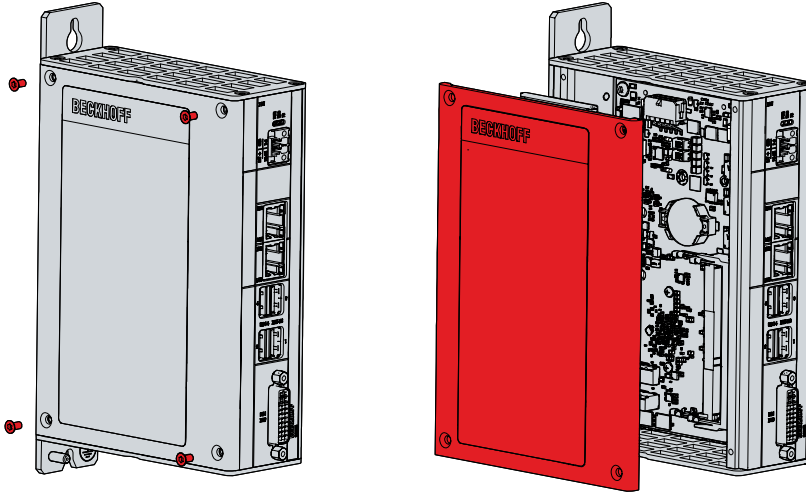

Fig. 15: Access to battery and storage medium

You now have access to the battery (1) and CFast (2) (see fig. 16).

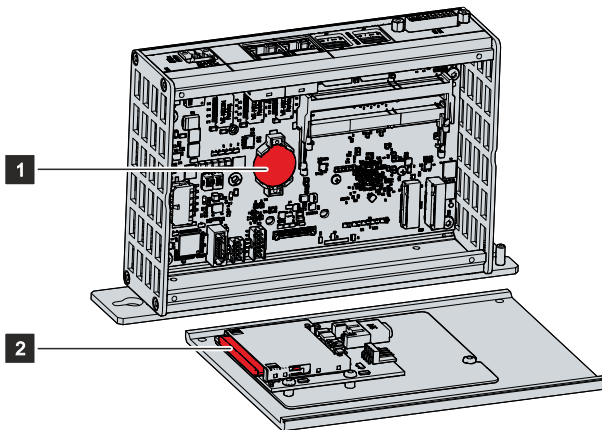

Fig. 16: Battery and CFast

## 7.2.2 Replacing the battery

### NOTICE

#### Incorrect battery type

Replace battery with R/C (BBCV2), Part. No. CR2032, rated 3 V only. Use of another battery may present a risk of fire or explosion.

- Only replace the battery with a replacement battery from Beckhoff Service.
- When replacing the battery, make sure that the polarity is correct.

### NOTICE

#### Battery damage

Incorrect handling of the motherboard battery can damage it.

- Do not recharge the battery.
- Do not throw the battery on the fire.
- Do not open the battery.
- Protect the battery against direct sunlight and moisture.

The Industrial PC does not contain a lithium-ion battery. The motherboard battery is a CR2032 lithium-metal cell. It is used to supply power to the clock integrated on the motherboard. If the battery is depleted or missing, the date and time are displayed incorrectly.

Table 13: Technical data of the battery.

Battery type	Electrical properties (at 20 °C)		Dimensions		
	Nominal voltage	Nominal capacity	Diameter	Height	Weight
CR2032	3.0 V	225 mAh	20.0 mm	3.20 mm	3.1 g

Chapter 7.2.1 [Access to device components](#) [▶ 34] shows how to access the battery.

To change the battery, proceed as follows:

1. Place a lever made on the negative pole of the battery holder below the battery.
2. Lift the battery side out of the holder.
  - ⇒ The battery is now in an oblique position (see fig. 17).

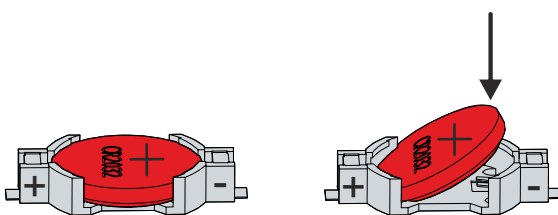

Fig. 17: Battery change

3. Remove the battery completely from the battery holder.
4. Insert the new battery with the correct polarity back into the inclined position on the positive pole of the battery holder. The correct polarity is shown in the figure.
5. Push the high side of the battery down into the battery holder (see fig. 17).
  - ⇒ You have successfully replaced the battery.

To dispose of the battery, remove it, stick insulating tape over the poles and take it to the local battery recycling.

## 7.2.3 Replacing the storage media

Storage media should only be obtained from Beckhoff Service (see Chapter 10.1 Service and support).

The old storage media must be disposed of in accordance with the national electronic waste regulations.

For new storage media, please contact your Beckhoff Sales only. Hard disks from Beckhoff are optimized for industrial applications. SSDs from Beckhoff have a considerably higher lifetime expectancy than commercially available SSDs.

### Data transmission before replacement

If you want to exchange a storage medium according to Beckhoff's recommendation, you must copy the data from the old to the new storage medium. You can use the Beckhoff Service Tool (BST) for this purpose. BST is a graphical backup and restore program for PCs with a Windows operating system. You can create an image of your operating system and use it to back up the operating system. Then you can restore the created image to a new data carrier. The BST is available on a bootable BST USB flash drive. This includes Windows and a backup software. Select the size of the BST USB flash drive according to the size of the backup copy of your operating system. You can then keep the flash drive as a backup copy. For this purpose, the BST USB flash drives are designed for particularly long data preservation by means of special flash. For more information on the function of the BST, please refer to the corresponding [manual](#).

If your storage medium is defective and there is no backup, Beckhoff Service can provide you with a fresh Windows image. For this to be possible, the Beckhoff PC must already have been shipped with a valid operating system license. After installing the fresh image, the applications must be reinstalled.

### Replacing the CFast

Chapter 7.2.1 [Access to device components](#) [► 34] shows how to access the CFast.

Proceed as follows to change the CFast:

1. Pull the CFast out of the holder (see fig. 18).
2. Insert the new CFast in the same direction back into the holder.

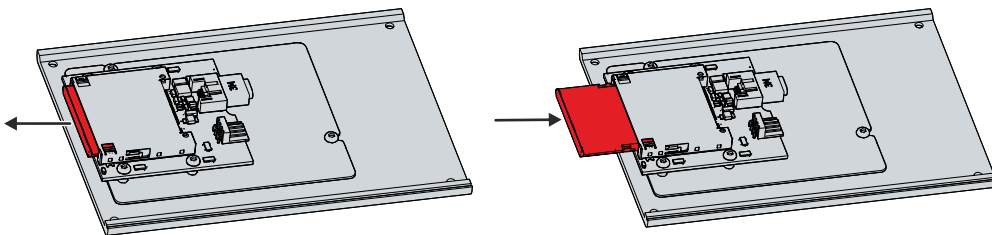

Fig. 18: Replacing the CFast

## 8 Troubleshooting

Fault	Cause	Measures
No function of the industrial PC	Missing power supply of the industrial PC Other cause	Check the power supply cable Call Beckhoff Service
The industrial PC does not boot fully	BIOS setup settings are incorrect Other causes	Check BIOS setup settings (load defaults) Call Beckhoff Service
Industrial PC boots, software starts, but the controller does not work properly	Cause of the fault is either in the software or in parts of the plant outside the industrial PC	Call the machine and software manufacturer
USB error during access with TwinCAT via USB	Cycle times in TwinCAT set to 10 ms (default)	Increase the cycle times to between 50 ms and 80 ms

## 9 Technical data

Table 14: Technical data

Product designation	C6905
Dimensions (W x H x D)	45 x 163 x 115 mm, without mounting plate
Weight	900 g with basic configuration
Supply voltage	22-30 V DC (24 V DC power supply unit) NEC Class 2
Power consumption	Data sheet for calculating power consumption and power loss in the download finder - Data sheets: <a href="http://www.beckhoff.com/downloadfinder">http://www.beckhoff.com/downloadfinder</a>
Protection rating	IP20
Vibration resistance (sinusoidal vibration)	EN 60068-2-6: 10 to 58 Hz: 0.035 mm 58 to 500 Hz: 0.5 G (approx. 5 m/s <sup>2</sup> )
Shock resistance (shock)	EN 60068-2-27: 5 G (approx. 50 m/s <sup>2</sup> ), duration: 30 ms
EMC interference immunity	conforms to EN 61000-6-2
EMC interference emission	conforms to EN 61000-6-4
Permissible ambient temperature	0 °C ... +55 °C (operation) -25 °C ... +65 °C (transport / storage)
Permissible air humidity	Maximum 95 %, no condensation
Transport and storage	The same values for air humidity and shock resistance are to be observed during transport and storage as in operation. The shock resistance during transport can be improved by means of suitably packing the industrial PC.

## 10 Appendix

In the appendix you will find information for servicing and details of the approvals that your device has.

### 10.1 Service and support

Beckhoff and its worldwide branch offices offer comprehensive service and support, providing fast and competent assistance with all issues relating to Beckhoff products and system solutions.

#### Beckhoff Service

The Beckhoff Service Center supports you in all matters of after-sales service:

- on-site service
- repair service
- spare parts service
- hotline service

Hotline: + 49 5246/963-460  
email: [service@beckhoff.com](mailto:service@beckhoff.com)

If your device requires service, please indicate the serial number, which you can find on the name plate.

#### Beckhoff Support

Support offers you comprehensive technical assistance, helping you not only with the application of individual Beckhoff products, but also with other, wide-ranging services:

- World-wide support
- Design, programming and commissioning of sophisticated automation systems
- extensive training program for Beckhoff system components

Hotline: + 49 5246/963-157  
email: [support@beckhoff.com](mailto:support@beckhoff.com)

#### Headquarters

Beckhoff Automation GmbH & Co. KG  
Hülshorstweg 20  
33415 Verl  
Germany

Phone: + 49 5246/963-0  
email: [info@beckhoff.de](mailto:info@beckhoff.de)

The addresses of the worldwide Beckhoff branches and agencies can be found on our website at <http://www.beckhoff.com/>.

You will also find further documentation for Beckhoff components there.

## 10.2 Approvals

Your device has at least the following approvals:

- CE
- EAC
- UKCA
- FCC

You will find all other applicable approvals on the name plate of your device.

### **FCC approvals for the United States of America**

FCC: Federal Communications Commission Radio Frequency Interference Statement

This device was tested and complies with the limits for a digital device of class A, according part 15 of the FCC regulations. These limits are designed to provide adequate protection against adverse interference, if the device is used in a commercial environment. This device generates, uses and may emit radio frequency energy and may cause adverse interference with radio communications, if it is not installed and used in accordance with the operating instructions. If this device is used in a residential area it is likely to cause adverse interference, in which case the user must take appropriate countermeasures in order to eliminate the interference at his own expense.

### **FCC approvals for Canada**

FCC: Canadian Notice

This device does not exceed the class A limits for radiation, as specified by the Radio Interference Regulations of the Canadian Department of Communications.



## List of figures

Fig. 1	Structure.....	10
Fig. 2	Voltage socket pin numbering.....	11
Fig. 3	Ethernet interfaces pin numbering .....	12
Fig. 4	USB interface pin numbering .....	14
Fig. 5	DVI interface .....	15
Fig. 6	Status LEDs .....	16
Fig. 7	Name plate example .....	17
Fig. 8	UPS function .....	18
Fig. 9	Mounting plate.....	20
Fig. 10	Dimensions standard mounting plate.....	21
Fig. 11	Control cabinet installation .....	22
Fig. 12	Beckhoff Device Manager - Change passwords.....	27
Fig. 13	Beckhoff Device Manager – Start page .....	28
Fig. 14	Dismantling the control cabinet .....	30
Fig. 15	Access to battery and storage medium.....	34
Fig. 16	Battery and CFast .....	34
Fig. 17	Battery change .....	35
Fig. 18	Replacing the CFast.....	36

## List of tables

Table 1	Key: C6905 structure .....	10
Table 2	Voltage socket pin assignment .....	11
Table 3	Controller classification based on device generations .....	12
Table 4	Ethernet interface pin assignment.....	12
Table 5	LED lighting speed 100/1000 Mbit/s .....	12
Table 6	LED lighting speed 100/1000/2500 Mbit/s .....	13
Table 7	USB interfaces based on device generation .....	14
Table 8	USB interface pin assignment.....	14
Table 9	DVI interface pin assignment .....	15
Table 10	Meaning of the Status LEDs .....	16
Table 11	Key: name plate C6905.....	17
Table 12	Device component replacement recommendations .....	32
Table 13	Technical data of the battery.....	35
Table 14	Technical data.....	38



More Information:  
[www.beckhoff.com/C6905/](http://www.beckhoff.com/C6905/)

Beckhoff Automation GmbH & Co. KG  
Hülshorstweg 20  
33415 Verl  
Germany  
Phone: +49 5246 9630  
[info@beckhoff.com](mailto:info@beckhoff.com)  
[www.beckhoff.com](http://www.beckhoff.com)

