

Manual | EN

# CX2500-0061

Power over Ethernet module





# Table of contents

<b>1 Foreword .....</b>	<b>5</b>
1.1 Notes on the documentation.....	5
1.2 Safety instructions .....	6
1.3 Documentation issue status .....	7
<b>2 Product overview.....</b>	<b>8</b>
2.1 Intended use.....	8
2.2 System overview .....	9
2.3 CX2500-0061 - Technical data.....	10
<b>3 Unpacking and transport .....</b>	<b>11</b>
<b>4 Mounting and wiring.....</b>	<b>12</b>
4.1 Installing at the CX20x0 system .....	12
4.2 Installing the bar clips .....	14
4.3 Installation on the mounting rail.....	15
4.4 Ethernet interface (X610) .....	18
<b>5 Error handling and diagnostics.....</b>	<b>19</b>
5.1 Diagnostic LEDs .....	19
5.2 Faults .....	20
<b>6 Removal and disposal.....</b>	<b>21</b>
<b>7 Appendix .....</b>	<b>23</b>
7.1 Certifications .....	23
7.2 Support and Service .....	24



# 1 Foreword

## 1.1 Notes on the documentation

This description is only intended for the use of trained specialists in control and automation engineering who are familiar with applicable national standards.

It is essential that the documentation and the following notes and explanations are followed when installing and commissioning the components.

It is the duty of the technical personnel to use the documentation published at the respective time of each installation and commissioning.

The responsible staff must ensure that the application or use of the products described satisfy all the requirements for safety, including all the relevant laws, regulations, guidelines and standards.

### Disclaimer

The documentation has been prepared with care. The products described are, however, constantly under development.

We reserve the right to revise and change the documentation at any time and without prior announcement. No claims for the modification of products that have already been supplied may be made on the basis of the data, diagrams and descriptions in this documentation.

### Trademarks

Beckhoff®, TwinCAT®, EtherCAT®, EtherCAT G®, EtherCAT G10®, EtherCAT P®, Safety over EtherCAT®, TwinSAFE®, XFC®, XTS® and XPlanar® are registered trademarks of and licensed by Beckhoff Automation GmbH.

Other designations used in this publication may be trademarks whose use by third parties for their own purposes could violate the rights of the owners.

### Patent Pending

The EtherCAT Technology is covered, including but not limited to the following patent applications and patents:

EP1590927, EP1789857, EP1456722, EP2137893, DE102015105702  
with corresponding applications or registrations in various other countries.

## EtherCAT®

EtherCAT® is a registered trademark and patented technology, licensed by Beckhoff Automation GmbH, Germany

### Copyright

© Beckhoff Automation GmbH & Co. KG, Germany.

The reproduction, distribution and utilization of this document as well as the communication of its contents to others without express authorization are prohibited.

Offenders will be held liable for the payment of damages. All rights reserved in the event of the grant of a patent, utility model or design.

## 1.2 Safety instructions

### Safety regulations

Please note the following safety instructions and explanations!  
Product-specific safety instructions can be found on following pages or in the areas mounting, wiring, commissioning etc.

### Exclusion of liability

All the components are supplied in particular hardware and software configurations appropriate for the application. Modifications to hardware or software configurations other than those described in the documentation are not permitted, and nullify the liability of Beckhoff Automation GmbH & Co. KG.

### Personnel qualification

This description is only intended for trained specialists in control, automation and drive engineering who are familiar with the applicable national standards.

### Description of symbols

In this documentation the following symbols are used with an accompanying safety instruction or note. The safety instructions must be read carefully and followed without fail!

#### **DANGER**

##### **Serious risk of injury!**

Failure to follow the safety instructions associated with this symbol directly endangers the life and health of persons.

#### **WARNING**

##### **Risk of injury!**

Failure to follow the safety instructions associated with this symbol endangers the life and health of persons.

#### **CAUTION**

##### **Personal injuries!**

Failure to follow the safety instructions associated with this symbol can lead to injuries to persons.

#### **NOTE**

##### **Damage to the environment or devices**

Failure to follow the instructions associated with this symbol can lead to damage to the environment or equipment.



##### **Tip or pointer**

This symbol indicates information that contributes to better understanding.

## 1.3 Documentation issue status

Version	Changes
1.0	First version

## 2 Product overview

### 2.1 Intended use

The CX20x0 device series is a modular control system designed for DIN rail installation. The system is scalable, so that the required modules can be assembled and installed in the control cabinet or terminal box as required.

#### Only switch the PC off after closing the software

Before the Embedded PC is switched off, the software currently running on it should be stopped properly in order to avoid data loss on the hard disk. Please read the section on "Switching off".

Switch off all system components and uncouple the Industrial PC from the system if the PC is not used for control purposes, e.g. during a function test. To disconnect first pull the first terminal behind the power supply unit (optional), then pull the connectors of the fieldbus connections. System components that have been switched off must be secured against being switched on again.

The Embedded PC's power supply unit must be supplied with 24 V<sub>DC</sub>.

#### NOTE

##### Damage to the environment or devices

Do not exchange any parts when under power! The exchange of controller parts when live can lead to short-circuits or overvoltages. These can damage the controller itself and connected peripherals (terminals, monitors, input devices, etc.).

When components are being fitted or removed, the supply voltage must be switched off.

#### Software knowledge

#### NOTE

##### System malfunctions

Mandatory software knowledge! Every user must be familiar with any of the functions of the software installed on the PC that he can reach.



## 2.2 System overview

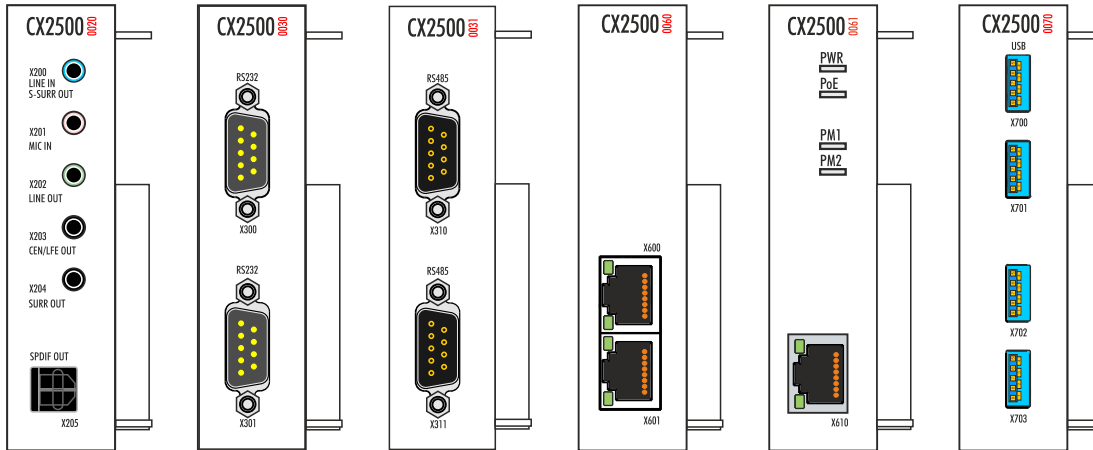

The system modules for the CX2000 family are connected to the CPU on the left-hand side via a multi-pin connector. Internally they are connected via PCI Express. Up to four modules can be connected in any order.

The CX2500-0020 audio module has jack plug (5 x 3.5 mm) and cinch plug for digital signals (SPDIF). Up to 7.1 multi-channel audio can be used. Serial interfaces can be added with the modules CX2500-0030 (RS232) and CX2500-0031 (RS422/RS485). The CX2500-0060 module provides two further independent Gbit Ethernet interfaces. The CX2500-0070 module can be used to add up to four further USB 3.0 interfaces.

### Power over Ethernet (PoE) module CX2500-0061

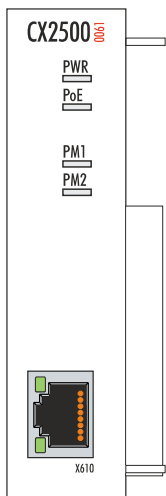

The CX2500-0061 Power over Ethernet module supports devices with PoE class 0, 1, 2, 3 and 4 in accordance with the PoE standard IEEE 802.3af-2003. The maximum PoE power output is 15.4 W. The PoE supply voltage is generated internally, no external power supply is necessary. In the case of an overload of the CX2500-0061, the PoE supply shuts down for two seconds, then restarts. The diagnostic LEDs PWR, PoE, PM1 and PM2 provide information about the type of PoE supply (mode A or B) as well as about the PoE class reported by the powered device.

## 2.3 CX2500-0061 - Technical data

### Dimensions

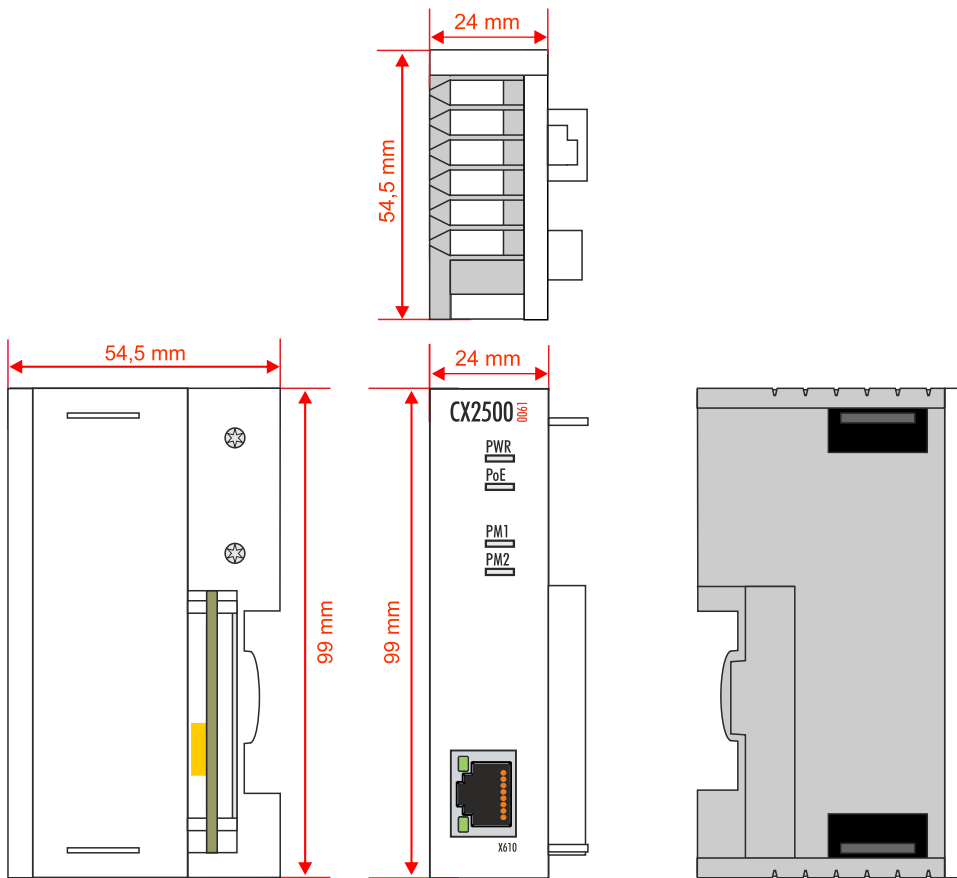

The system module CX2500-0061 provides a further Power over Ethernet (PoE) interface for the CX20x0.

Technical data	CX2500-0061
Interfaces	1 x RJ45, 10/100/1000 MBit/s with Power-over-Ethernet (PoE)
max. PoE power delivery	15,4 W
Supported devices	Devices of PoE Class 0, 1, 2, 3 and 4 as defined by PoE standard IEEE 802.3af-2003
Power supply	via system bus (through CX2100-0xxx power supply modules) internal generation of PoE supply voltage (no external 48 V power feeding required)
max. Power loss	3 W
Dielectric strength	500 V (supply / internal electronics)
Dimensions (W x H x D)	24 mm x 99 mm x 54,5 mm
Weight	approx. 208 g
Operating/storage temperature	-25° C ... +60° C / -40° C ... +85° C
Relative humidity	95 %, no condensation
Vibration/shock resistance	conforms to EN 60068-2-6/EN 60068-2-27
EMC immunity/emission	conforms to EN 61000-6-2/EN 61000-6-4
Protection class	IP 20

Further Information: [www.beckhoff.de/CX2000](http://www.beckhoff.de/CX2000)

### 3 Unpacking and transport

---

#### ● Short circuit due to moisture

**i** Moisture can lead to short circuits. Moisture can form during transport in cold weather or in the event of large temperature fluctuations.

Avoid moisture formation (condensation) in the device, and leave the device to adjust to room temperature slowly. If condensation has occurred, wait at least 12 hours before switching on the device.

---

#### Proceed as follows to unpack the unit:

1. Remove packaging.
2. Do not discard the original packaging. Keep it for transporting the device in the future.
3. Check the delivery for completeness by comparing it with your order.
4. Please keep the associated paperwork. It contains important information for handling the unit.
5. Check the contents for visible shipping damage.
6. If you notice any shipping damage or inconsistencies between the contents and your order, you should notify Beckhoff Service.

#### Shipping and relocation

Despite the robust design of the unit, the components are sensitive to strong vibrations and impacts. Therefore, during transport please protect your device from:

- mechanical stress and
- use the original packaging.

Follow the specified storage conditions for the device and store it at temperatures between -40 °C and +85 °C.

## 4 Mounting and wiring

### 4.1 Installing at the CX20x0 system

#### **i** Damage to the contacts

Incorrect installation may result in damage to the contacts of the system modules.

The system modules may only be attached on the left-hand side of the basic CPU module.

A maximum of four system modules can be attached to the basic CPU module via the internal PCI Express bus. In delivery state the system module is equipped with a protective cap for the bus connector. Before continuing, connect the system module to the basic CPU module.

Prerequisites for this step:

- Exit the software and shut down the CX20x0 hardware configuration.
- Switch off the power supply.

Install the system module as follows:

1. Put a screwdriver into the recess on the short side of the protective cap and lever it off.

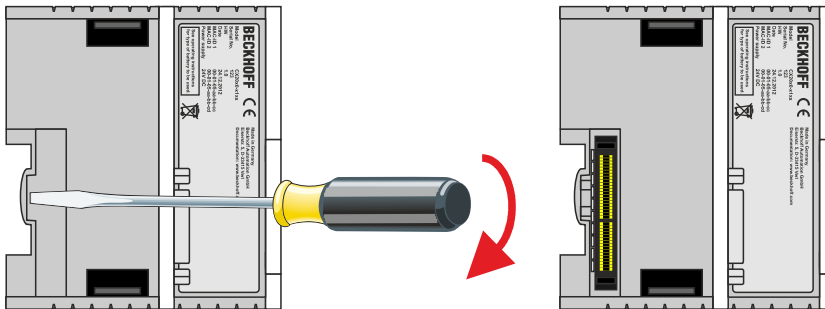

2. Remove the protective cap to expose the bus connector.
3. Insert the system module on the **left-hand side** of the basic CPU module.

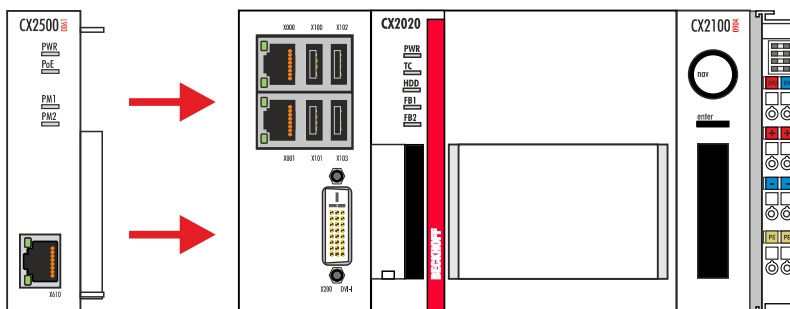

4. The module clicks into the basic CPU module.

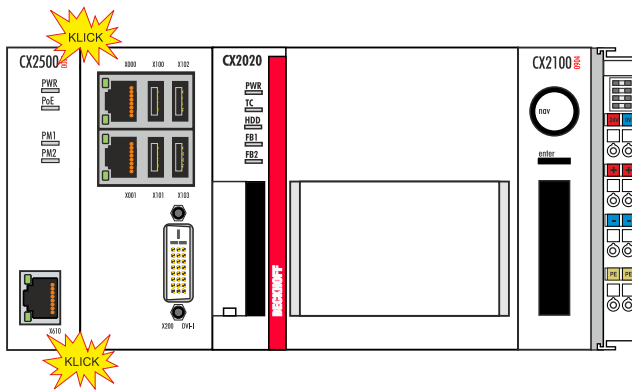

- ⇒ The system module has been installed successfully, if the individual modules were connected straight and flush.  
Next, you can install the bar clips, thereby reinforcing interlocking of the modules.

## 4.2 Installing the bar clips

### Installing the bar clips

Usually, the connection between the modules is strong enough. However, the basic CPU module and the fieldbus modules may be subjected to shocks, vibrations or other impacts. The modules can be securely connected to one another with the aid of bar clips.

#### Install the bar clips as follows:

1. Attach the bar clips to the top and bottom of the devices.

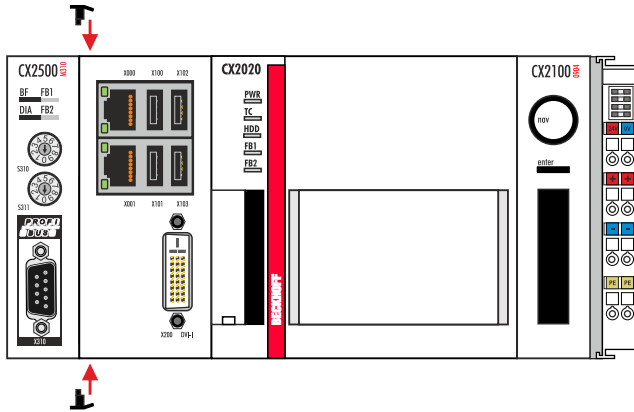

2. Push the bar clips between the cooling fins of your devices, as shown in the image below.



- ⇒ The bar clips have been installed successfully, if they don't protrude and are level with the cooling fins of your modules.  
Once all fieldbus modules are locked, the whole assembly can be installed on the mounting rail.

### 4.3 Installation on the mounting rail

**i** **Installation position and minimum distances**

The modules or devices may overheat, if the installation position is incorrect or the minimum distances are not adhered to.

The devices may only be operated at ambient temperatures up to 60 °C. Ensure adequate ventilation. Choose a horizontal installation position for the devices. Leave at least 30 mm clearance above and below the installed devices.

**Correct installation position**

The devices may be operated up to an ambient temperature of 60 °C. The high performance and the compact design of the CX2000 Embedded PC series may result in increased heat generation. The heat is dissipated via a passive ventilation system. Venting of the devices requires a correct installation position.

Ventilation openings are located at the top and bottom of the housing. The system therefore has to be installed horizontally. This ensures optimum airflow through the devices in vertical direction.

During installation, leave at least 30 mm clearance above and below the devices to ensure adequate ventilation.

The images below show the permitted and two unacceptable installation positions:

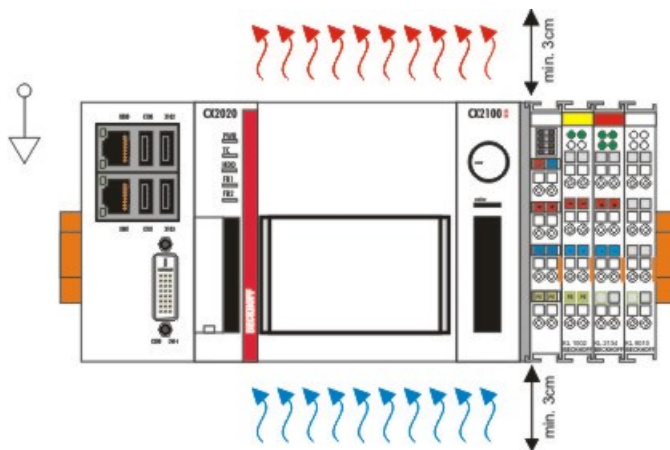

gültige Installationslage  
valid position

**Incorrect installation positions**

The CX20x0 system must not be operated vertically on the DIN rail. This installation position provides insufficient ventilation for the devices. In horizontal position the devices are not sufficiently ventilated either.

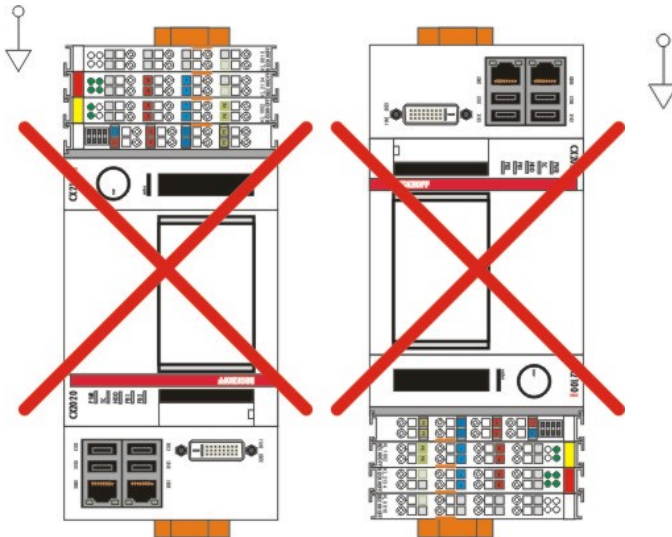

ungültige Installationslage  
invalid position

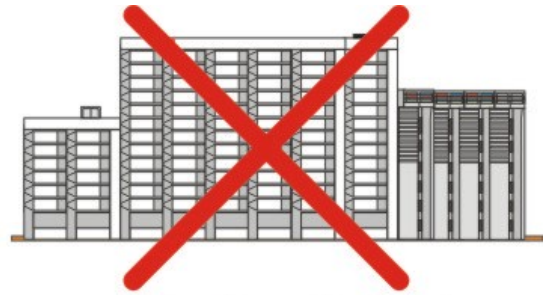

ungültige Installationslage  
invalid position

**Installation on the mounting rail**

**i** **Avoid damage**

Do not use force or excessive pressure when installing the devices on the mounting rail.

The CX20x0 can easily be installed on the mounting rail. The housing is designed such that it can be pushed against the mounting rail and engaged on it.

**Install the devices on the mounting rail as follows:**

1. Unlock the latches at the top and bottom.

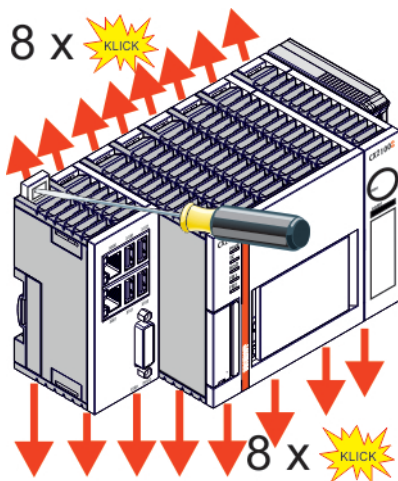



2. Position the devices at the front of the mounting rail. Gently push the devices onto the mounting rail until you can hear a click and the devices are engaged.

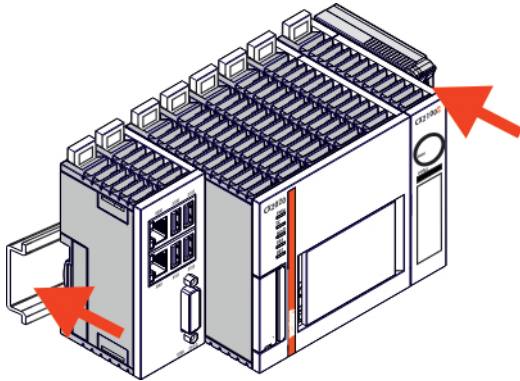

3. Then lock the latches again.

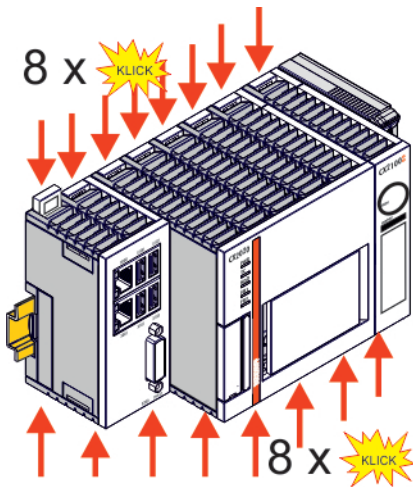

- ⇒ The devices are now installed successfully. Verify that the devices are installed correctly and that all devices are engaged on the mounting rail. In the next step you can commission the devices.

## 4.4 Ethernet interface (X610)

The CX2500-0061 system module supplies PoE-capable devices with voltage via the Ethernet interface (X610). The required voltage is generated internally in the CX2500-0061 system module. An external power supply unit is not necessary.



Devices that are not PoE-capable can also be connected to the Ethernet interface (X610). The CX2500-0061 system module checks connected devices before the start and tests them for their PoE capability.

### Energy supply

The following methods are available for the energy supply and data rates of **up to 100 Mbit/s**:

- Mode A: the voltage is transmitted by the data cores of the Ethernet cable.  
With this method the voltage for the energy supply is superimposed on the data signal. The same core pairs (1/2 and 3/6) are used for the energy supply and the data transmission.
- Mode B: the voltage is transmitted by the free cores of the Ethernet cable.  
With this method the free core pairs (4/5 and 7/8) are used to supply the voltage. The data transmission and energy supply are cleanly separated.

Modes A and B are mixed for data rates of **1000 Mbit/s (Gigabit)**. The data transmission and energy supply are not separated and the voltage for the energy supply is superimposed on the data signal.

Table 1: Pin assignment of the PoE-capable interface

PIN	Description	10, 100 Mbit/s		1000 Mbit/s (1 Gigabit/s)	
		Mode A	Mode B	Mode A	Mode B
1	Pair 2	Rx+ / DC-	Rx +	TxRx+ / DC-	TxRx+
2		Rx- / DC-	Rx-	TxRx- / DC-	TxRx-
3	Pair 3	Tx+ / DC+	Tx+	TxRx+ / DC+	TxRx+
4	Pair 1	-	DC+	TxRx+	TxRx+ / DC+
5		-	DC+	TxRx-	TxRx- / DC+
6	Pair 3	Tx- / DC+	Tx -	TxRx- / DC+	TxRx-
7	Pair 4	-	DC-	TxRx+	TxRx+ / DC-
8		-	DC-	TxRx-	TxRx- / DC-

### Requirements for the Ethernet cable

- Mode A: a 4-core cable is adequate for 10BASE-T and 100BASE-TX Data rates of 10 and 100 Mbit/s are supported.  
  
An 8-core cable is required for 1000BASE-T. Data rates of 1000 Mbit/s are supported.
- Mode B: an 8-core cable is required for 10BASE-T, 100BASE-TX and 1000BASE-T. Speeds of 10, 100 and 1000 Mbit/s are supported.

Always use Cat5e Ethernet cables in order to be able to operate the maximum number of PoE devices from different manufacturers. The maximum cable length is 100 m.

## 5 Error handling and diagnostics

### 5.1 Diagnostic LEDs

Display	LED	Description	Color	Meaning
	PWR	Power supply	green	The power LED lights if connected to a power supply and the unit is switched on.
	PoE	Indicates the status of the powered device.	green	Lights green when the powered device is connected and powered.
			red	Flashing red if overloaded.
	PM1	Number of connected ports.	green	Lights green when the powered consumer is supplied with one pair of conductors (Mode A or Mode B).
			blue	Lights blue when the powered consumer is supplied with two pair of conductors (Mode A and Mode B).
	PM2	Indicates the PoE class of the powered device.	green	Lights green if a powered device with PoE class 0 to 3 is connected.
			blue	Lights blue if a powered device with PoE class 4 is connected.
	LINK / ACT	Indicates if a powered device is connected.	yellow	The LED lights yellow if a powered device is connected. The LED flashes if data traffic takes place.
	SPEED	Indicates the connection speed.	green	The LED is green if the speed is 10 or 100 Mbit.
			red	In 1000 Mbit mode (Gigabit) the LED is red.

## 5.2 Faults

Please also refer to the Safety instructions section.

### Possible faults and their correction

Fault	Cause	Measures
no function after the Embedded PC has been switched on	no power supply for the Embedded PC other causes	1. Check the fuse 2. Measure voltage at connection, check plug wiring, call Beckhoff support
Embedded PC does not boot fully	Hard disk damaged (e.g. due to switching off while software is running), incorrect setup, other causes	Check setup Call Beckhoff Support
Computer boots, software starts, but control does not operate correctly	Cause of the fault is either in the software or in parts of the plant outside the Embedded PC	Call the manufacturer of the machine or the software.
CF card access error	Faulty CFast card, faulty CFast slot	Use a different CFast card to check the CFast slot Call Beckhoff Support
Embedded PC only works partially or temporarily	Defective components in the Embedded PC	Call Beckhoff support

Please make a note of the following information **before** contacting Beckhoff service or support:

1. Precise device ID: CXxxxx-xxxx
2. Serial number
3. Hardware version
4. Any interfaces (N030, N031, B110, ...)
5. TwinCAT version used
6. Any components / software used

The quickest response will come from support / service in your country. Therefore please contact your regional contact. For details please refer to our website at [www.beckhoff.de](http://www.beckhoff.de) or ask your distribution partner.

## 6 Removal and disposal

### ● Electrical voltage

**i** Having the power supply switched on during the installation may damage the device.  
Switch off the power supply during the installation.

### ● Cabling

**i** Make a note of the wiring configuration, if you wish to restore it with another device.

The CX2000 Embedded PC series is a modular system and enables individual modules to be replaced or removed quite easily. This section describes how to remove devices from the CX2000 Embedded PC series.

Prerequisites for this step:

- Exit the software and shut down the CX20x0 hardware configuration.
- Disconnect the power supply.

**Remove the devices as follows:**

1. Remove the wiring from the basic CPU module, any system interfaces that may be connected and the extension modules.
2. Remove the wiring from the first terminal next to the power supply unit.
3. Pull the orange tab to remove the terminal.

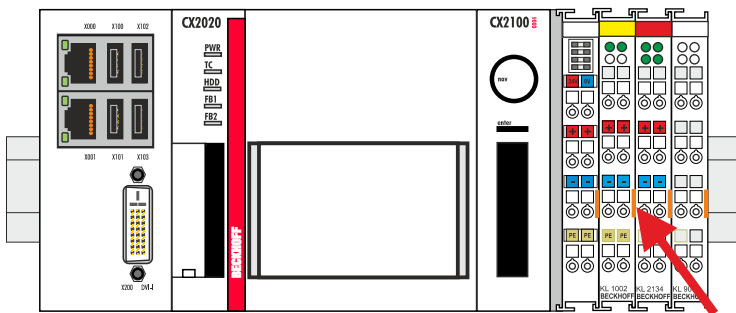

4. Release the DIN rail mounting by pushing the latches outwards with a screwdriver.

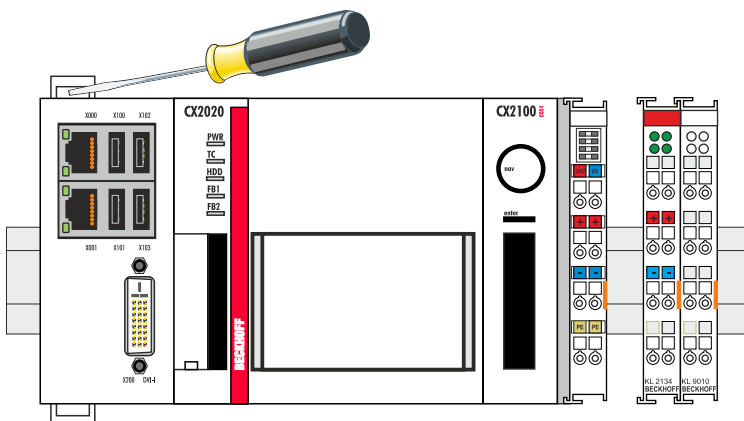

5. Pull the orange tab on the power supply unit and gently remove the device from the DIN rail.

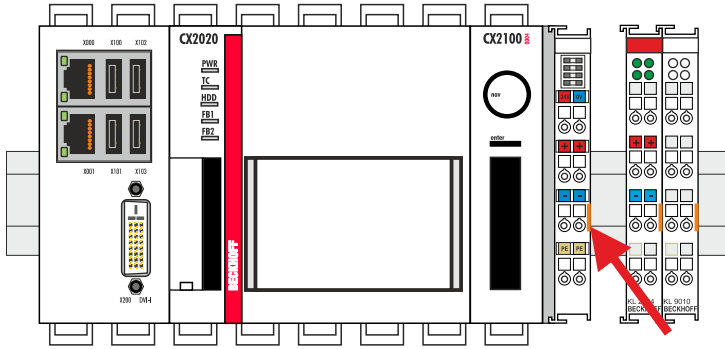

Next, you can remove the bar clips, in order to release the modules.

### Removing the bar clips

In order to dismantle the assembly it must first be removed from the support rail. The bar clips can then be removed with the aid of a screwdriver.

#### Remove the bar clips as follows:

1. Lift the bar clips with the aid of a screwdriver and remove the bar clips.

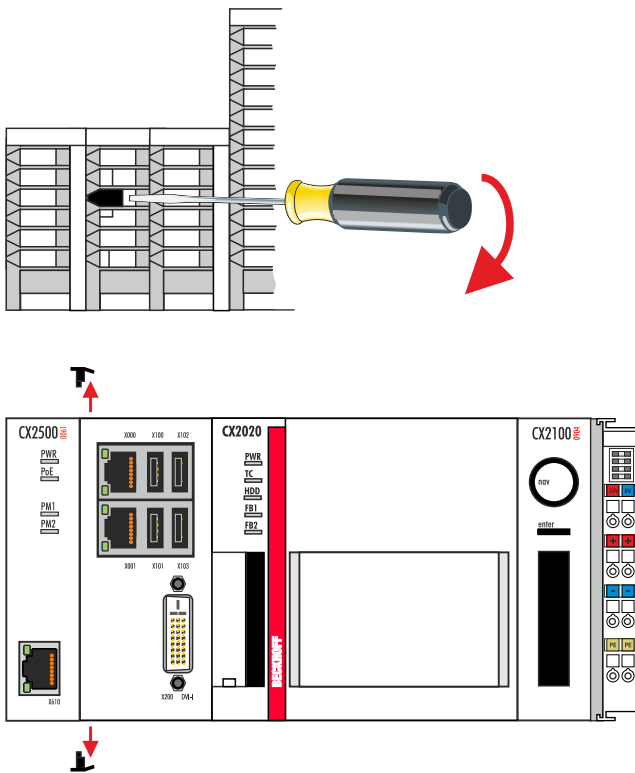

Once the bar clips have been removed successfully, the modules can be separated from each other.

### Disposal

The device must be fully dismantled in order to dispose of it.

Electronic components must be disposed of according to national electronic waste regulations

## 7 Appendix

### 7.1 Certifications

All products of the Embedded PC family are CE, UL and EAC certified. Since the product family is continuously developed further, we are unable to provide a full listing here. The current list of certified products can be found at [www.beckhoff.com](http://www.beckhoff.com).

#### **FCC Approvals for the United States of America**

##### **FCC: Federal Communications Commission Radio Frequency Interference Statement**

This equipment has been tested and found to comply with the limits for a Class A digital device, pursuant to Part 15 of the FCC Rules. These limits are designed to provide reasonable protection against harmful interference when the equipment is operated in a commercial environment. This equipment generates, uses, and can radiate radio frequency energy and, if not installed and used in accordance with the instruction manual, may cause harmful interference to radio communications. Operation of this equipment in a residential area is likely to cause harmful interference in which case the user will be required to correct the interference at his own expense.

#### **FCC Approval for Canada**

##### **FCC: Canadian Notice**

This equipment does not exceed the Class A limits for radiated emissions as described in the Radio Interference Regulations of the Canadian Department of Communications.

## 7.2 Support and Service

Beckhoff and their partners around the world offer comprehensive support and service, making available fast and competent assistance with all questions related to Beckhoff products and system solutions.

### Beckhoff's branch offices and representatives

Please contact your Beckhoff branch office or representative for local support and service on Beckhoff products!

The addresses of Beckhoff's branch offices and representatives round the world can be found on her internet pages:

<http://www.beckhoff.com>

You will also find further documentation for Beckhoff components there.

### Beckhoff Headquarters

Beckhoff Automation GmbH & Co. KG

Huelshorstweg 20  
33415 Verl  
Germany

Phone: +49(0)5246/963-0  
Fax: +49(0)5246/963-198  
e-mail: [info@beckhoff.com](mailto:info@beckhoff.com)

### Beckhoff Support

Support offers you comprehensive technical assistance, helping you not only with the application of individual Beckhoff products, but also with other, wide-ranging services:

- support
- design, programming and commissioning of complex automation systems
- and extensive training program for Beckhoff system components

Hotline: +49(0)5246/963-157  
Fax: +49(0)5246/963-9157  
e-mail: [support@beckhoff.com](mailto:support@beckhoff.com)

### Beckhoff Service

The Beckhoff Service Center supports you in all matters of after-sales service:

- on-site service
- repair service
- spare parts service
- hotline service

Hotline: +49(0)5246/963-460  
Fax: +49(0)5246/963-479  
e-mail: [service@beckhoff.com](mailto:service@beckhoff.com)





More Information:  
**[www.beckhoff.com/CX2500-0061](http://www.beckhoff.com/CX2500-0061)**

Beckhoff Automation GmbH & Co. KG  
Hülshorstweg 20  
33415 Verl  
Germany  
Phone: +49 5246 9630  
[info@beckhoff.com](mailto:info@beckhoff.com)  
[www.beckhoff.com](http://www.beckhoff.com)

