

Documentation | EN

ELM72xx

Servomotor terminals in a metal housing



Table of contents

1	Product overview	5
2	Foreword	6
2.1	Notes on the documentation	6
2.2	Safety instructions	7
3	System overview	8
4	Product description	9
4.1	ELM72xx-0010	9
4.1.1	Introduction	9
4.1.2	Technical data	10
4.1.3	Connection	12
4.1.4	Displays, diagnostics	18
4.1.5	Scope of supply	20
4.1.6	Dimensions	21
5	Mounting and wiring	22
5.1	Instructions for ESD protection	22
5.2	Mounting IP20 terminals	23
5.2.1	Installation positions	23
5.2.2	ELM/EKM terminal mounting on DIN rail	25
5.2.3	Positioning of passive Terminals	28
5.3	Shielding concept, grounding	29
5.3.1	Shield connection for OCT motor cables	29
5.3.2	Shield connection for additional signals	30
5.4	Notes on current measurements using Hall sensors	31
5.5	Connection system / wiring	32
5.5.1	EMC measures	32
5.5.2	Wiring push-in connector	32
6	Technical information	34
6.1	Functional technology	34
6.1.1	Servomotor	34
7	Short guide to commissioning	35
7.1	Requirements	35
7.2	Wiring	35
7.3	Integrating into a TwinCAT project	36
7.4	Configuration using the Drive Manager 2	37
7.4.1	Creating a Drive Manager 2 project	37
7.4.2	Setting basic parameters	39
7.5	Test run	41
7.5.1	Preparation	41
7.5.2	Axis enable	42
7.5.3	Manual operation	43
7.6	Controller optimization	45
7.6.1	Optimization of the current controller	45
7.6.2	Optimization of the speed controller	46

7.6.3	Optimization of the position controller	48
8	Commissioning	49
8.1	Restoring the delivery state	49
8.2	Controller operation mode	51
8.2.1	CSP	51
8.2.2	CSV	53
8.2.3	CST (torque control)	53
8.2.4	CSTCA	53
8.3	Electronic identification plate of motors	54
8.4	The "NC Feed constant" parameter	55
8.5	Diagnosis	56
8.5.1	Diagnostics - basic principles of diag messages	56
8.5.2	Notes on Diag Messages associated with Motor Terminals	65
9	Advanced device information	66
9.1	Controller structure	66
9.2	CoE parameters	67
9.2.1	Configuration data	67
9.2.2	Configuration data vendor-specific	81
9.2.3	Command object	84
9.2.4	Input data	85
9.2.5	Output data	92
9.2.6	Information data, diagnostic data	98
9.2.7	Standard objects	106
10	Accessories	140
11	Appendix	141
11.1	Documentation issue status	141
11.2	Disposal	142
11.3	Support and Service	143

1 Product overview

This documentation describes the following products:

Type	Number of channels	Output current (rms) per channel
ELM7211-0010	1	4.5 A
ELM7212-0010	2	4.5 A
ELM7221-0010	1	8 A
ELM7222-0010	2	8 A
ELM7231-0010	1	16 A

2 Foreword

2.1 Notes on the documentation

Intended audience

This description is only intended for the use of trained specialists in control and automation engineering who are familiar with the applicable national standards.

It is essential that the documentation and the following notes and explanations are followed when installing and commissioning these components.

The qualified personnel is obliged to always use the currently valid documentation.

The responsible staff must ensure that the application or use of the products described satisfy all the requirements for safety, including all the relevant laws, regulations, guidelines and standards.

Disclaimer

The documentation has been prepared with care. The products described are, however, constantly under development.

We reserve the right to revise and change the documentation at any time and without prior announcement.

No claims for the modification of products that have already been supplied may be made on the basis of the data, diagrams and descriptions in this documentation.

Trademarks

Beckhoff®, TwinCAT®, TwinCAT/BSD®, TC/BSD®, EtherCAT®, EtherCAT G®, EtherCAT G10®, EtherCAT P®, Safety over EtherCAT®, TwinSAFE®, XFC®, XTS® and XPlanar® are registered trademarks of and licensed by Beckhoff Automation GmbH. Other designations used in this publication may be trademarks whose use by third parties for their own purposes could violate the rights of the owners.

Patent Pending

The EtherCAT Technology is covered, including but not limited to the following patent applications and patents: EP1590927, EP1789857, EP1456722, EP2137893, DE102015105702 with corresponding applications or registrations in various other countries.



EtherCAT® is registered trademark and patented technology, licensed by Beckhoff Automation GmbH, Germany.

Copyright

© Beckhoff Automation GmbH & Co. KG, Germany.

The reproduction, distribution and utilization of this document as well as the communication of its contents to others without express authorization are prohibited.

Offenders will be held liable for the payment of damages. All rights reserved in the event of the grant of a patent, utility model or design.

2.2 Safety instructions

Safety regulations

Please note the following safety instructions and explanations!
Product-specific safety instructions can be found on following pages or in the areas mounting, wiring, commissioning etc.

Exclusion of liability

All the components are supplied in particular hardware and software configurations appropriate for the application. Modifications to hardware or software configurations other than those described in the documentation are not permitted, and nullify the liability of Beckhoff Automation GmbH & Co. KG.

Personnel qualification

This description is only intended for trained specialists in control, automation and drive engineering who are familiar with the applicable national standards.

Signal words

The signal words used in the documentation are classified below. In order to prevent injury and damage to persons and property, read and follow the safety and warning notices.

Personal injury warnings

⚠ DANGER

Hazard with high risk of death or serious injury.

⚠ WARNING

Hazard with medium risk of death or serious injury.

⚠ CAUTION

There is a low-risk hazard that could result in medium or minor injury.

Warning of damage to property or environment

NOTICE

The environment, equipment, or data may be damaged.

Information on handling the product



This information includes, for example:
recommendations for action, assistance or further information on the product.

3 System overview



Compact drive technology in robust metal housing

The ELM72xx EtherCAT Terminals are fully-fledged servo drives in a robust metal housing with an output current (I_{rms}) of up to 16 A at 48 V_{DC} voltage for the power supply.

They expand the Beckhoff portfolio of compact drive technology in terminal format and offer all current technology features with increased performance and functionality compared to the comparable EL versions.

The metal housing of the ELM72xx results in optimal heat dissipation even at high output powers as well as good shielding against electrical interference. The servo terminals can be directly connected to the EtherCAT Terminals and are therefore an integral part of the Beckhoff I/O system. The comprehensive functionality includes the direct connection of motor, feedback and brake via the convenient connector front end, an integrated absolute value interface and the One Cable Technology (OCT). Additional I/Os enable latching of position values. The integrated brake chopper control also allows a braking resistor to be connected directly. Compared to the EL series, the wiring level of the ELM72xx is designed to be pluggable. Matching motor and sensor cables further simplify installation. The design of the drive - ELM72xx combined with servomotors [AM8100](#) - is done as usual via the TwinCAT 3 Motion Designer ([TE5910](#)). Commissioning is very easy thanks to the electronic identification plate and the TwinCAT 3 Drive Manager 2 ([TE5950](#)).

4 Product description

4.1 ELM72xx-0010

4.1.1 Introduction



ELM7211-0010

ELM7221-0010



ELM7212-0010

ELM7222-0010



ELM7231-0010

The ELM72xx Servomotor EtherCAT Terminal with integrated absolute value interface offers high servo performance in a very compact design. The fast control technology, based on field-orientated current and PI speed control, supports fast and highly dynamic positioning tasks. The monitoring of numerous parameters, such as overvoltage and undervoltage, overcurrent, terminal temperature or motor load via the calculation of a I²T model, offers maximum operational reliability.

With the One Cable Technology (OCT) the encoder cable is omitted by transmitting the signals digitally via the existing motor cable. The option to read the electronic identification plates of suitable motors from the AM81xx series enables a plug-and-play solution for maximum convenience during commissioning.

The product is complemented by additional I/Os such as 2 digital inputs, which can be used to detect the end positions or to latch the position, and an additional output for the direct connection of a braking resistor for dissipating fed-back energy.

Special features

- Automatic reading of the electronic identification plate
- Pluggable connection technology

4.1.2 Technical data

All values are typical values over the entire temperature range, unless stated otherwise.

4.1.2.1 General technical data

E-bus	
Electrical isolation	500 V (E-bus / I/O)
Distributed Clocks	yes
Current consumption via E-bus	120 mA

Supply voltages	
Electronics supply voltage	$U_P = 24 V_{DC}$ via the power contacts
Current consumption from the power contacts	50 mA + holding current for the motor brake
Current load of the power contacts	max. 10 A
DC link voltage	8 ... 48 V_{DC} (must be supplied externally. Connection X004)

Environmental conditions	
Ambient temperature during operation	0 ... +55 °C
Ambient temperature during storage	-25 ... +85 °C
Relative humidity	95 % no condensation
Vibration/shock resistance	conforms to EN 60068-2-6 / EN 60068-2-27
EMC immunity / emission	conforms to EN 61000-6-2 / EN 61000-6-4
Protection rating	IP20

Approvals/markings	
Approvals/markings	CE, UL in preparation

4.1.2.2 Function-specific technical data

Inputs and outputs	
Inputs	2 x digital input per channel for Touch Probes (limit switches) 1 x feedback
Outputs	1 x servomotor 1 x motor brake 1 x braking resistor

Cable lengths	
OCT cable	max. 20 m
Sensor cable for digital inputs (touch probes)	max. 30 m

Motor output stage	ELM7211	ELM7212	ELM7221	ELM7222	ELM7231
Motor type	Servomotor				
Number of channels	1	2	1	2	1
Output current (rms) per channel	4.5 A	4.5 A	8 A	8 A	16 A
Peak current (rms) per channel	max. 9 A for 1 s	max. 9 A for 1 s	max. 16 A for 1 s	max. 16 A for 1 s	max. 30 A for 1 s
Rotary field frequency	0 ... 599 Hz				
PWM clock frequency	16 kHz				
Current controller frequency	32 kHz				
Position controller frequency	16 kHz				
Speed controller frequency	16 kHz				

Output for the motor brake	
Output voltage	24 V _{DC}
Output current	<ul style="list-style-type: none"> • ELM721x: max. 0.5 A • ELM722x: max. 0.5 A • ELM723x: max. 0.7 A

Encoder	
Interface	OCT encoder

Braking resistor	
Minimum resistance	3 Ω
Maximum resistance	100 Ω

4.1.2.3 Housing data

Housing data	
Design	Metal housing with signal LEDs
Weight	approx. 390 g
Installation position	tbd
Material	Zinc die-cast
Dimensions (W x H x D)	30 mm x 100 mm x 95 mm
Assembly	On 35 mm DIN rail, according to EN 60715. With lock.

4.1.3 Connection

Information on wiring can be found in the chapters [Connection system / wiring \[▶ 32\]](#) and [Shielding concept, grounding \[▶ 29\]](#).

The following subchapters show connection examples and pin assignments of the ELM72xx-0010 product variants.

4.1.3.1 ELM7211 and ELM7221

NOTICE

Incorrect signal levels due to electromagnetic interference

The digital inputs are optimized for fast signal transmission and are therefore susceptible to electromagnetic interference.

Under the influence of electromagnetic interference, a false signal level can be detected.

- If necessary, use shielded signal lines.

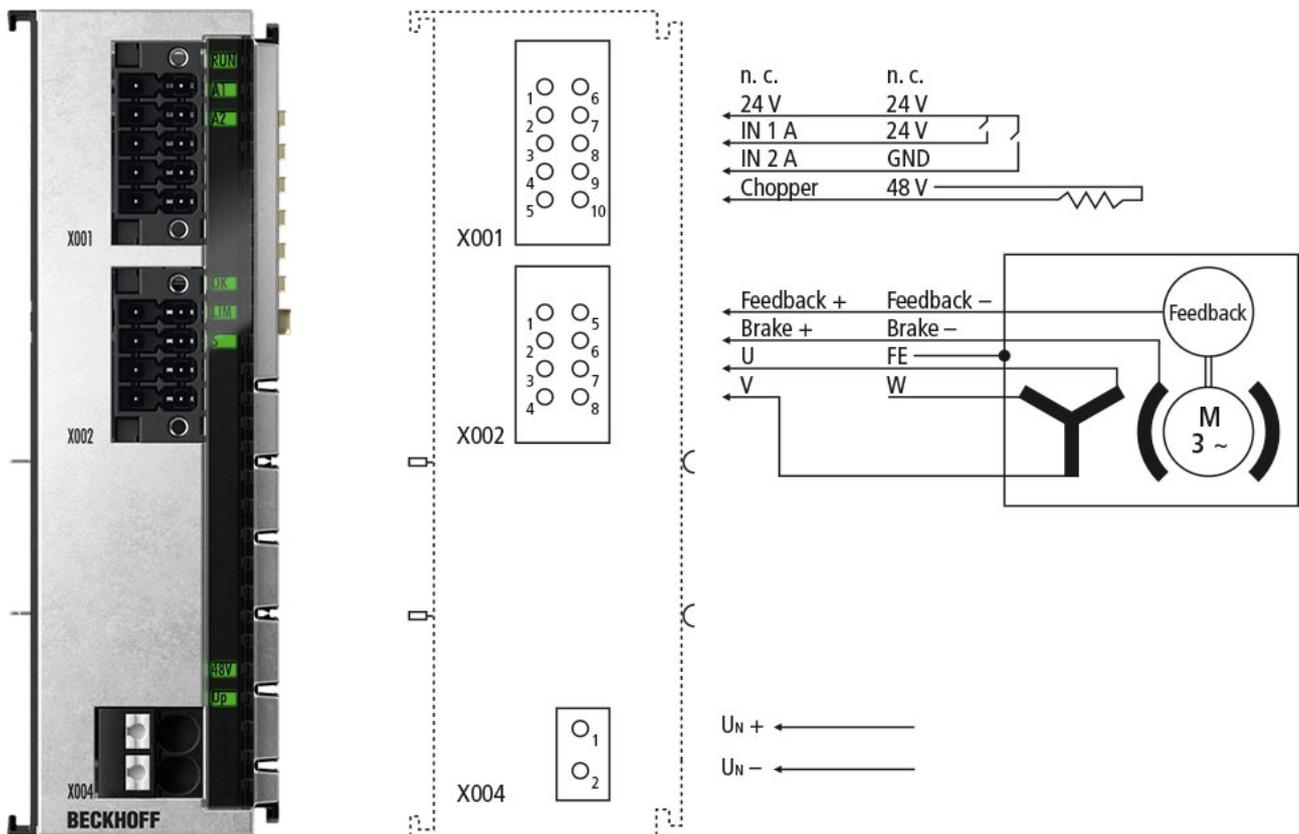

X001

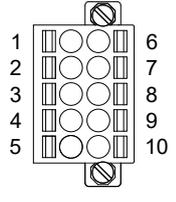
Connection	Pin	Name	Function
	1	n.c.	-
	2	24 V	24 V U _P Voltage output
	3	IN 1A	Fast digital input 1 for a Touch Probe (limit switch)
	4	IN 2A	Fast digital input 2 for a Touch Probe (limit switch)
	5	Chopper	Connection for a passive braking resistor. Connect the other connection cable of the braking resistor to pin 10.
	6	n.c.	-
	7	24 V	24 V U _P Voltage output
	8	24 V	24 V U _P Voltage output
	9	GND	Ground
	10	DC+	Connection for a passive braking resistor. Connect the other connection cable of the braking resistor to pin 5.

X002

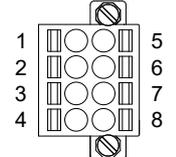
Connection	Pin	Name	Function
	1	Feedback+	OCT data cable
	2	Brake+	Output for the motor brake
	3	U	Motor phase U
	4	V	Motor phase V
	5	Feedback-	OCT data cable
	6	Brake-	Output for the motor brake
	7	FE	Functional earth
	8	W	Motor phase W

X004

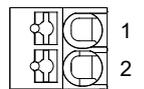
Connection	Pin	Name	Function
	1	DC+	DC link voltage input
	2	GND	Ground

4.1.3.2 ELM7212 and ELM7222

NOTICE

Incorrect signal levels due to electromagnetic interference

The digital inputs are optimized for fast signal transmission and are therefore susceptible to electromagnetic interference.

Under the influence of electromagnetic interference, a false signal level can be detected.

- If necessary, use shielded signal lines.

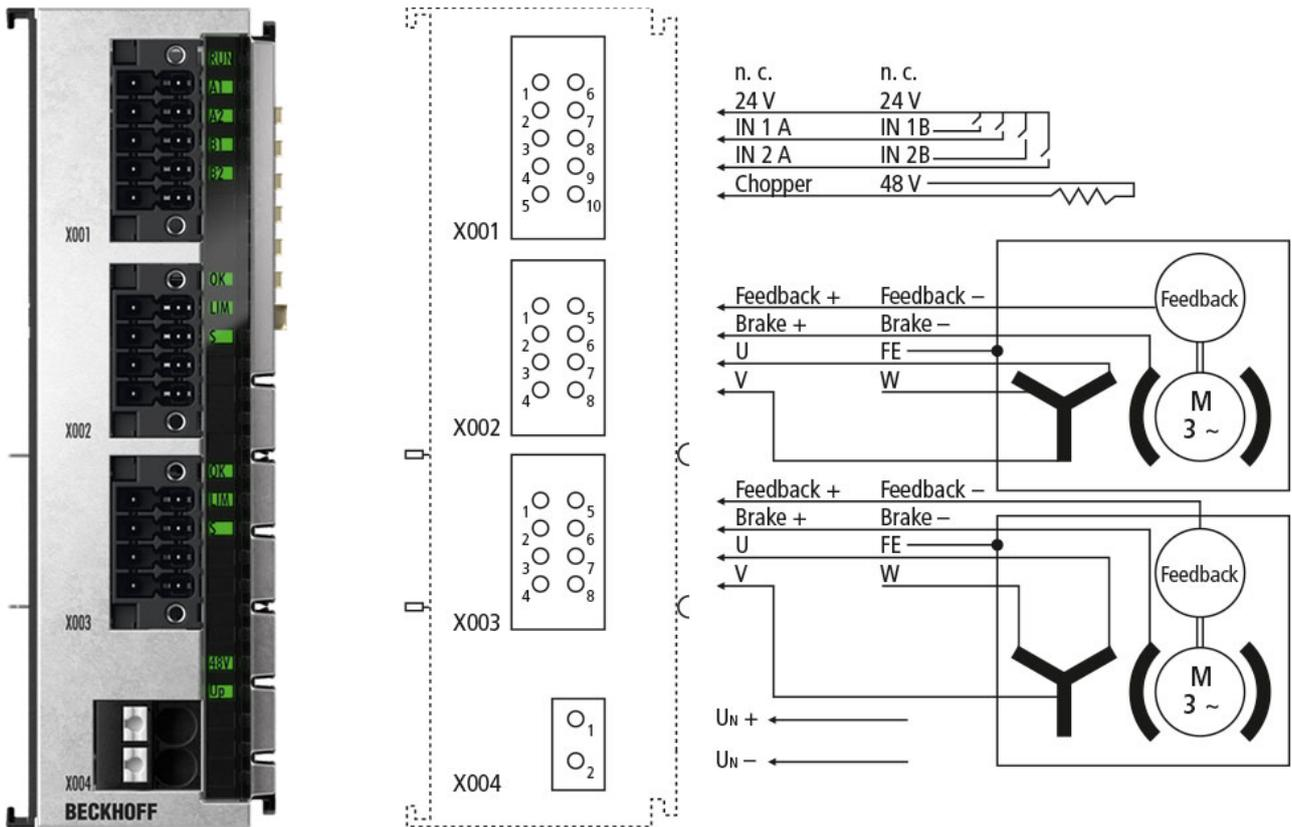

X001

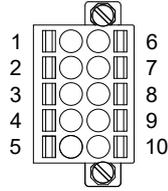
Connection	Pin	Name	Function
	1	n.c.	-
	2	24 V	24 V U _P Voltage output
	3	IN 1 A	Fast digital input 1 for a Touch Probe (limit switch) on motor channel A
	4	IN 2 A	Fast digital input 2 for a Touch Probe (limit switch) on motor channel A
	5	Chopper	Connection for a passive braking resistor. Connect the other connection cable of the braking resistor to pin 10.
	6	n.c.	-
	7	24 V	24 V U _P Voltage output
	8	IN 1 B	Fast digital input 1 for a Touch Probe (limit switch) on motor channel B
	9	IN 2 B	Fast digital input 2 for a Touch Probe (limit switch) on motor channel B
	10	DC+	Connection for a passive braking resistor. Connect the other connection cable of the braking resistor to pin 5.

**X002
X003**

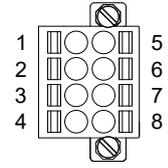
Connection	Pin	Name	Function
	1	Feedback+	OCT data cable
	2	Brake+	Output for the motor brake
	3	U	Motor phase U
	4	V	Motor phase V
	5	Feedback-	OCT data cable
	6	Brake-	Output for the motor brake
	7	FE	Functional earth
	8	W	Motor phase W

X004

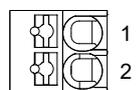
Connection	Pin	Name	Function
	1	DC+	DC link voltage input
	2	GND	Ground

4.1.3.3 ELM7231

NOTICE

Incorrect signal levels due to electromagnetic interference

The digital inputs are optimized for fast signal transmission and are therefore susceptible to electromagnetic interference.

Under the influence of electromagnetic interference, a false signal level can be detected.

- If necessary, use shielded signal lines.

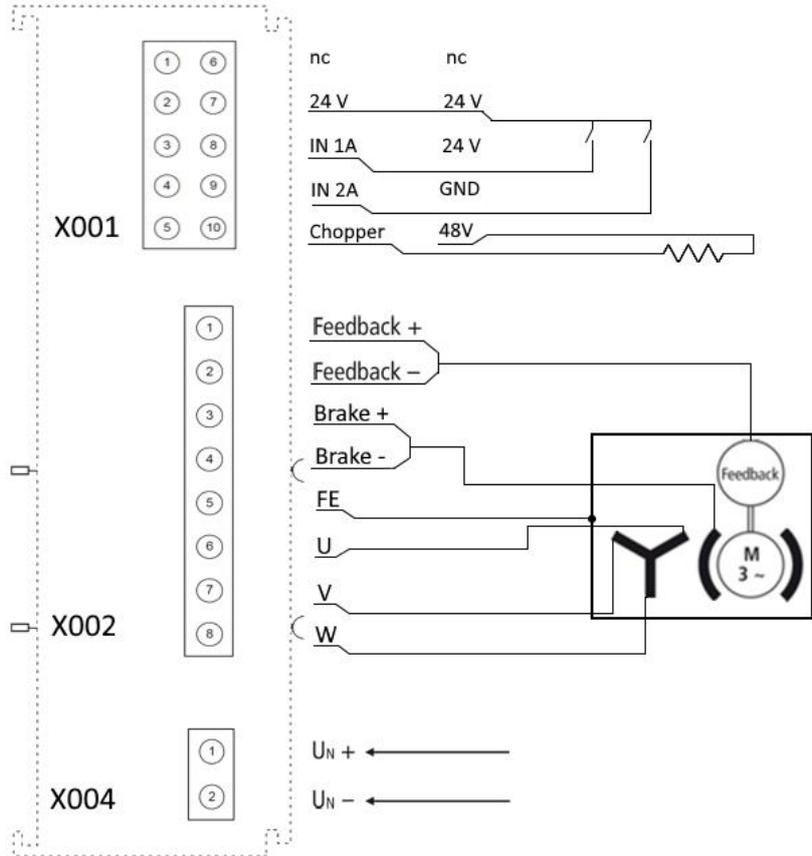

X001

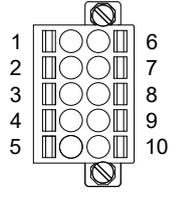
Connection	Pin	Name	Function
	1	n.c.	-
	2	24 V	24 V U _P Voltage output
	3	IN 1A	Fast digital input 1 for a Touch Probe (limit switch)
	4	IN 2A	Fast digital input 2 for a Touch Probe (limit switch)
	5	Chopper	Connection for a passive braking resistor. Connect the other connection cable of the braking resistor to pin 10.
	6	n.c.	-
	7	24 V	24 V U _P Voltage output
	8	24 V	24 V U _P Voltage output
	9	GND	Ground
	10	DC+	Connection for a passive braking resistor. Connect the other connection cable of the braking resistor to pin 5.

X002

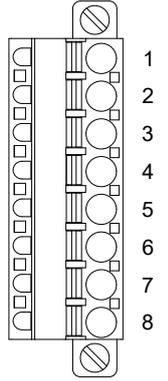
Connection	Pin	Name	Function
	1	Feedback+	OCT data cable
	2	Feedback-	OCT data cable
	3	Brake+	Output for the motor brake
	4	Brake-	Output for the motor brake
	5	FE	Functional earth
	6	U	Motor phase U
	7	V	Motor phase V
	8	W	Motor phase W

X004

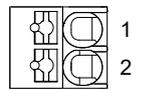
Connection	Pin	Name	Function
	1	DC+	DC link voltage input
	2	GND	Ground

4.1.4 Displays, diagnostics

Several LEDs are assigned to each port.

The following figure shows the position of the LEDs on the housing.

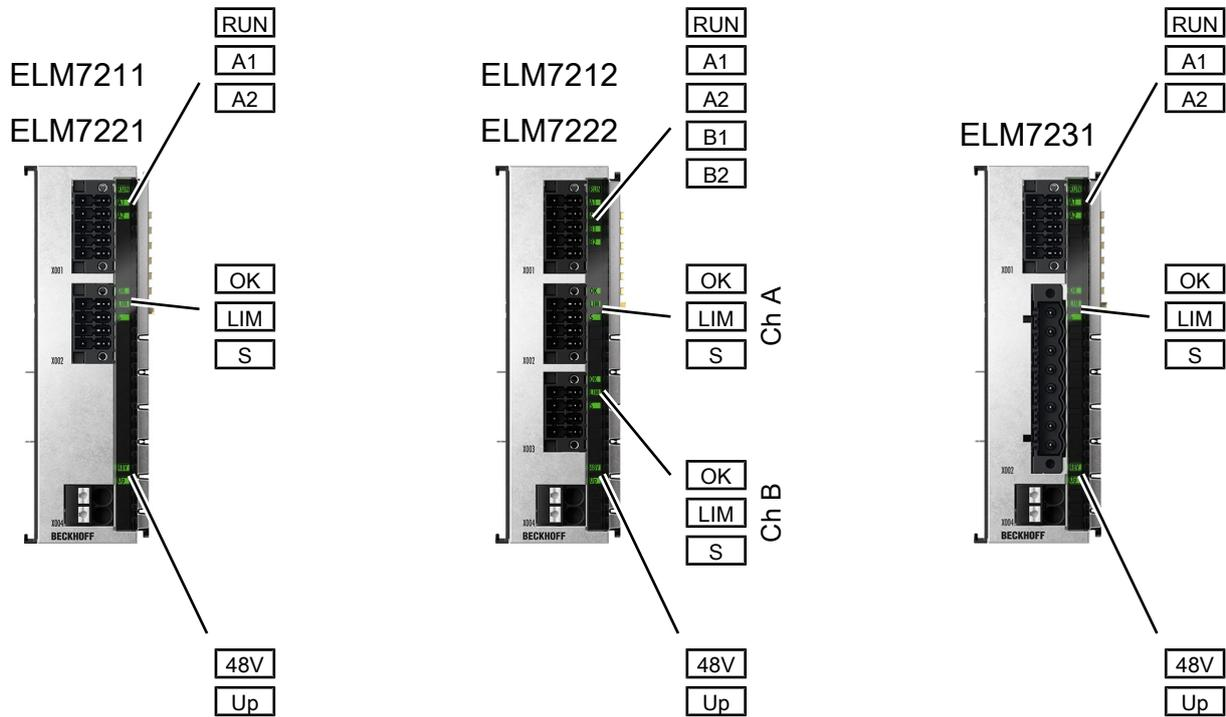

LEDs on X001

LED	Meaning	
RUN	Status of the terminal in the EtherCAT network.	
	off	Status "Init"
	flashes	Status "Pre-Operational"
	Single flash	Status "Safe-Operational"
	lit	Status "Operational"
A1	Status of Touch Probe "IN 1A": connector X001, pin 3.	
A2	Status of Touch Probe "IN 2A": connector X001, pin 4.	
B1 (ELM72x2 only)	Status of Touch Probe "IN 1B": connector X001, pin 8.	
B2 (ELM72x2 only)	Status of Touch Probe "IN 2B": connector X001, pin 9.	

LEDs at X002 and X003

LED	Meaning	
OK	off	The axis is switched off.
	flashing green	An OCT encoder is searched for or initialized.
	green illuminated	The axis is switched on.
	flashes orange	Warning + OCT encoder is being searched for or initialized.
	orange illuminated	Warning. See chapter Diagnosis [► 56] .
	flashes red	Error + OCT encoder is searched for or initialized.
	red illuminated	Error. If the "LIM" LED also lights up red: special case, see below.
LIM	orange illuminated	Internal limitation active; e.g. <ul style="list-style-type: none"> • Current • Speed • Power limitation brake chopper
	red illuminated	If the "OK" LED also lights up red: special case, see below.
S	- not used -	

Special case: both LEDs "OK" and "LIM" light up permanently red. This means that the control voltage U_s was unexpectedly switched off during operation.

LEDs on X004

LED	Meaning	
48V ¹⁾	green illuminated	The DC link voltage is applied to connector X004.
Up	green illuminated	The electronics supply voltage $U_p = 24 V_{DC}$ is applied to the power contacts.

¹⁾ The LED is labeled "48V". But it also lights up when another DC link voltage is connected that meets the specifications. See chapter [General technical data \[► 10\]](#).

4.1.5 Scope of supply

Make sure that the following accessories are included in the scope of delivery:

ELM7211 / ELM7221

- 1 push-in connector with 2x5 positions
- 1 push-in connector with 2x4 positions
- 1 shielding bracket for connecting the OCT motor cables

ELM7212 / ELM7222

- 1 push-in connector with 2x5 positions
- 2 push-in connectors with 2x4 positions
- 1 shielding bracket for connecting the OCT motor cables

ELM7231

- 1 push-in connector with 2x5 positions
- 1 push-in connector with 1x8 positions
- 1 shielding bracket for connecting the OCT motor cables

4.1.6 Dimensions

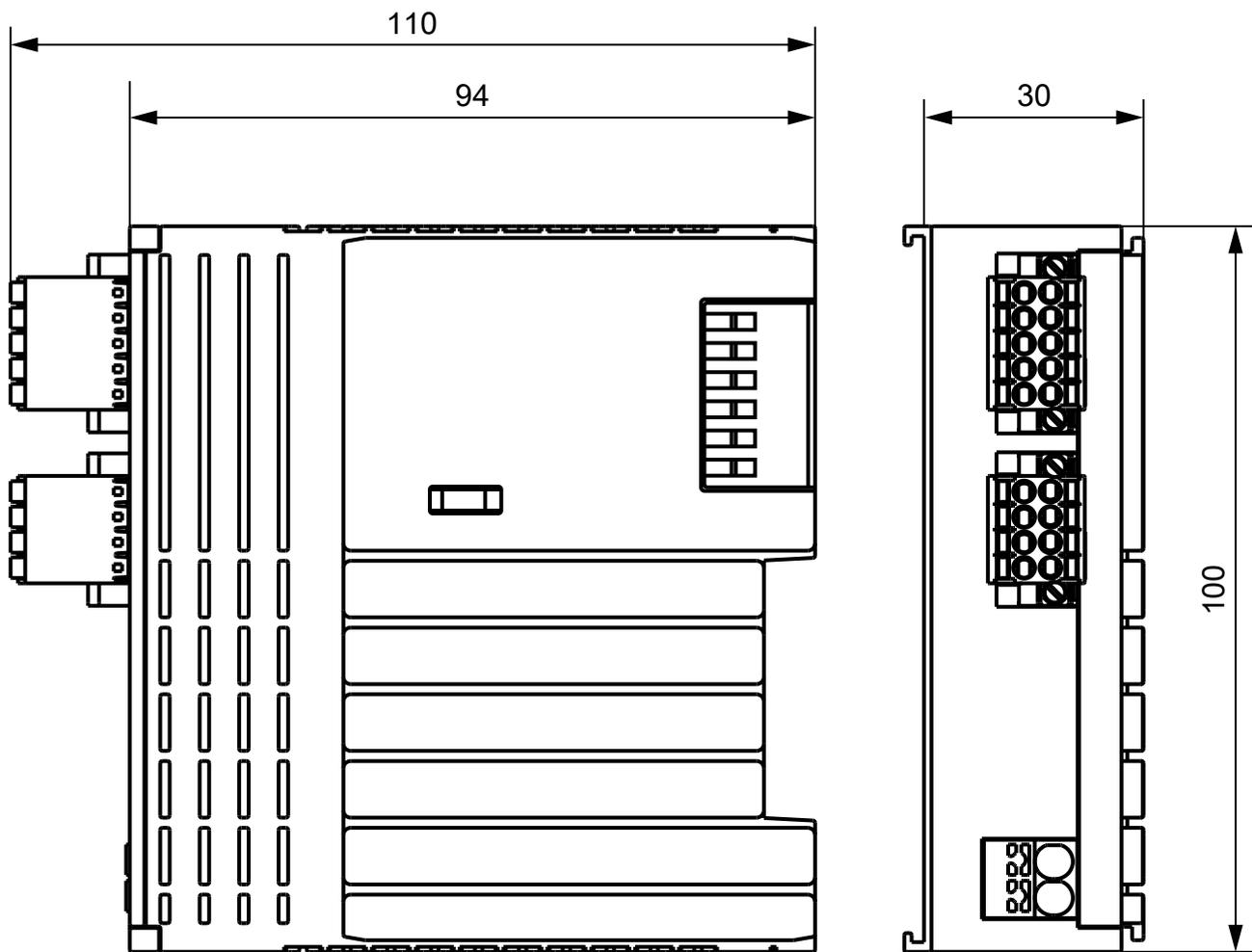

All dimensions are given in millimeters.
The drawing is not true to scale.

5 Mounting and wiring

5.1 Instructions for ESD protection

NOTICE

Devices can be destroyed by electrostatic charging!

The devices contain electrostatically sensitive components which can be damaged by improper handling.

- Please ensure you are electrostatically discharged when handling the components; also avoid touching the spring contacts directly (see illustration).
- Avoid contact with highly insulating materials (synthetic fibers, plastic films etc.)
- When handling the components, ensure good grounding of the environment (workplace, packaging and persons)
- Each bus station must be terminated on the right side with the [EL9011](#), [EL9012](#) or [ELM9012](#) end cap to ensure the protection rating and ESD protection.

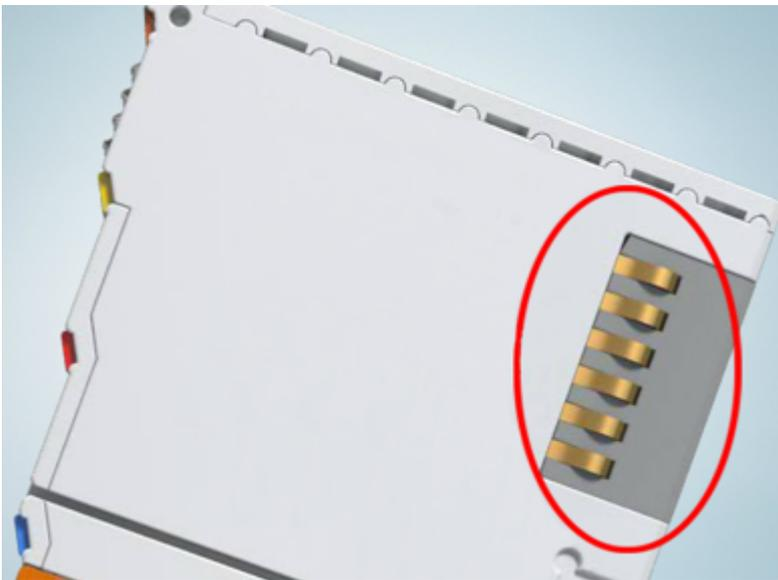

Fig. 1: Spring contacts of Beckhoff I/O components

5.2 Mounting IP20 terminals

5.2.1 Installation positions

NOTICE

Constraints regarding installation position and operating temperature range

Please refer to the technical data for a terminal to ascertain whether any restrictions regarding the installation position and/or the operating temperature range have been specified. When installing high power dissipation terminals ensure that an adequate spacing is maintained between other components above and below the terminal in order to guarantee adequate ventilation!

Optimum installation position (standard)

The optimum installation position requires the mounting rail to be installed horizontally and the connection surfaces of the EL/KL terminals to face forward (see Fig. "Recommended distances for standard installation position"). The terminals are ventilated from below, which enables optimum cooling of the electronics through convection. "From below" is relative to the acceleration of gravity.

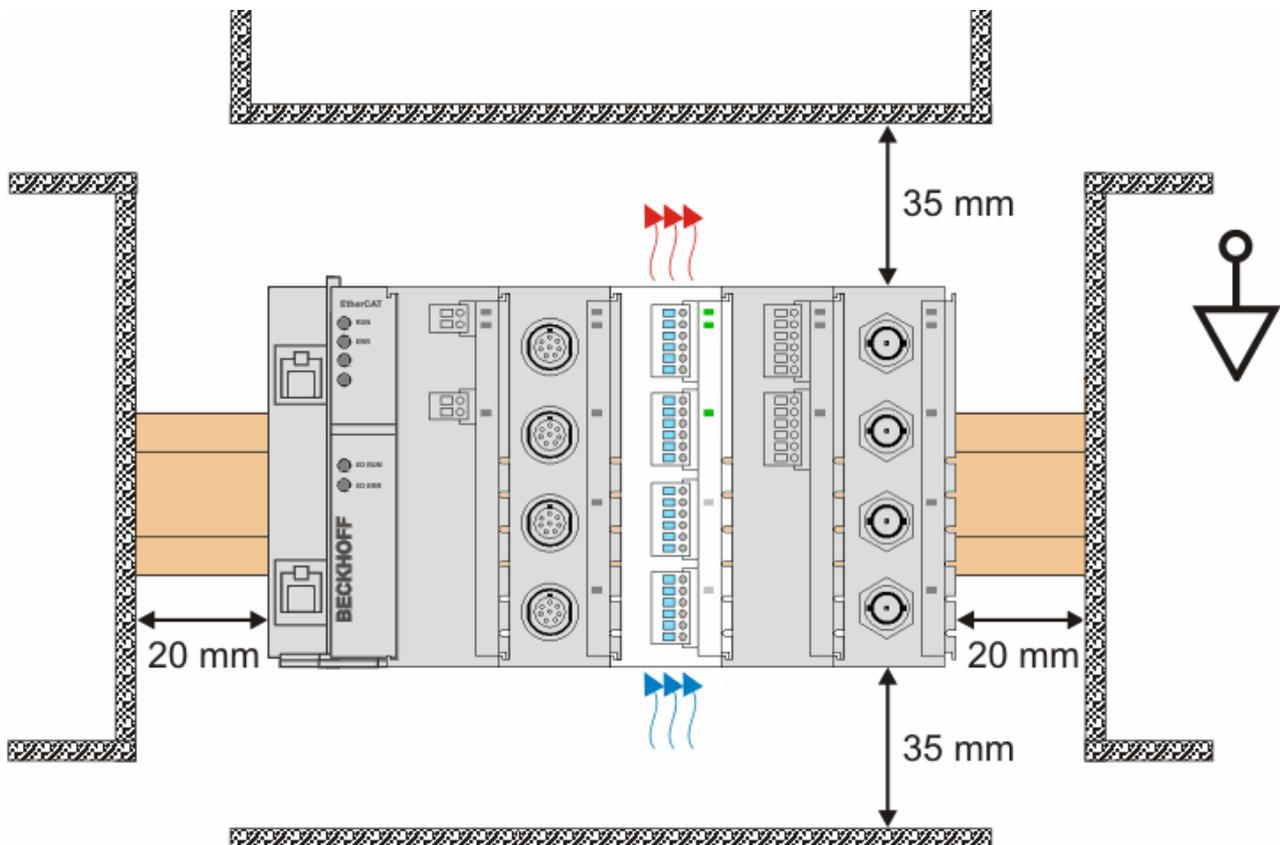

Fig. 2: Recommended distances for standard installation position

Compliance with the distances shown in Fig. "Recommended distances for standard installation position" is recommended.

Other installation positions

All other installation positions are characterized by different spatial arrangement of the mounting rail - see Fig "Other installation positions".

The minimum distances to ambient specified above also apply to these installation positions.

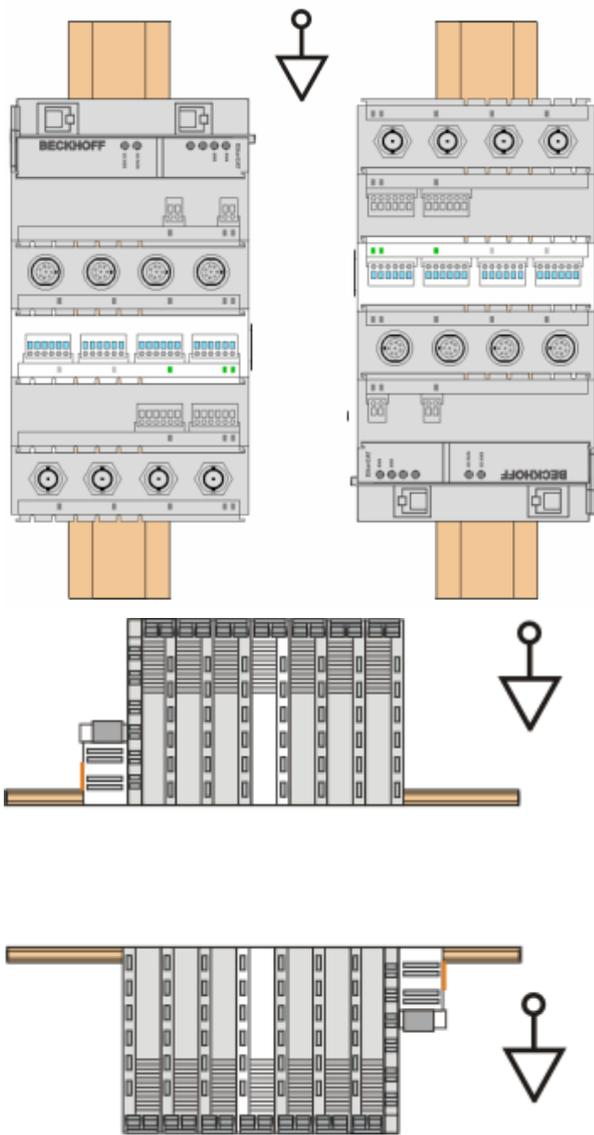

Fig. 3: Other installation positions

5.2.2 ELM/EKM terminal mounting on DIN rail

⚠ WARNING

Risk of electric shock and damage of device!

Bring the bus terminal system into a safe, powered down state before starting installation, disassembly or wiring of the bus terminals!

Assembly

The ELM terminals are locked to commercially available 35 mm mounting rails (DIN rails according to EN 60715) as following described:

- The ELM terminal can easily be latched onto the DIN rail. Therefore the clips of the terminal on top and down side have to be opened first:

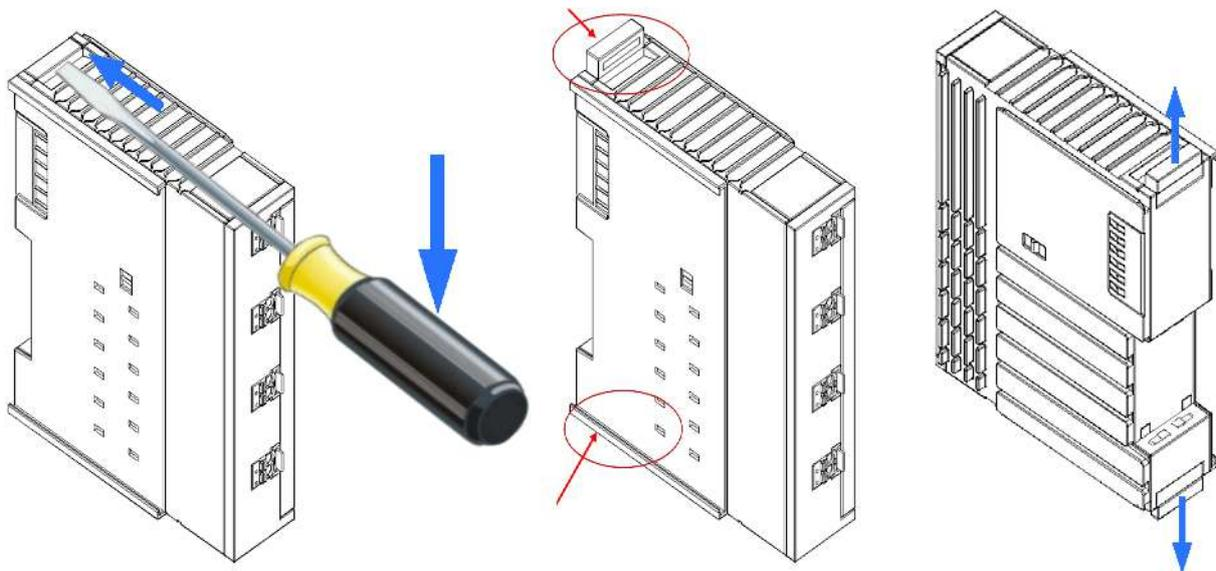

Fig. 4: Opening the clips on top and down side by lifting them e.g. with a screw driver

- Insert the ELM terminal to other already on the DIN rail arranged moduls together with tongue and groove and push the terminals against the mounting rail, until it clicks onto the touchdown point of the mounting rail. Then close the both clips on top and down side of the terminal respectively:

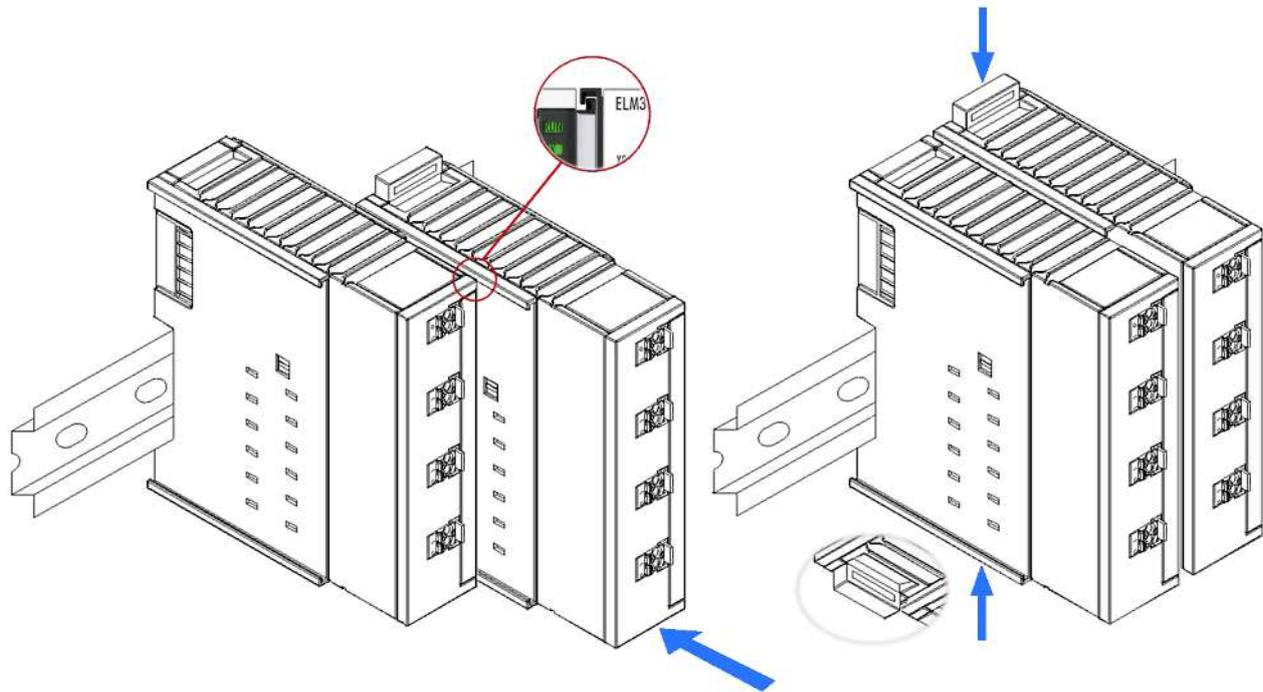
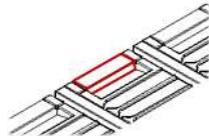

Fig. 5: Push-in of the ELM terminal and closing the mounting rail clips top and down

- During closing of the both clips there mustn't be a disruptive mechanical resistance being noticeable. The clips have to be snapped so that they're ending flat with the housing:



Attention: If the ELM terminal is clipped onto the mounting rail first and then pushed together without tongue and groove, the connection will not be operational! When correctly assembled, no significant gap should be visible between the housings.

Disassembly

Each ELM terminal is secured by a lock on the mounting rail, which must be released for disassembly. The procedure for demounting have to be done in *reverse* order as described in [Assembly](#) [► 25]:

1. Release the mounting rail lock of the ELM terminal on the top and down side and you can pull the terminal out of the bus terminal block easily without excessive force.
2. Grasp the released terminal with thumb and index finger simultaneous at the upper and lower grooved housing surfaces and pull the terminal out of the bus terminal block.

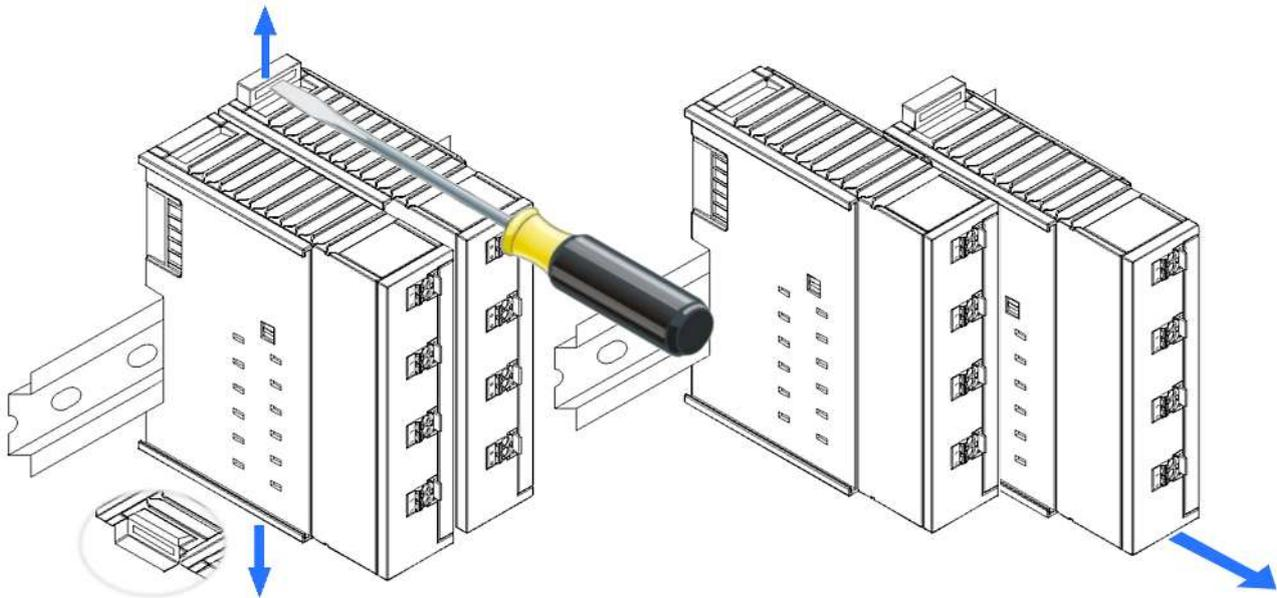

Fig. 6: Opening of the upper and lower mounting rail lock and pull out the ELM terminal module

Connections within a bus terminal block

The electric connections between the Bus Coupler and the Bus Terminals are automatically realized by joining the components: The six spring contacts of the K-Bus/E-Bus deal with the transfer of the data and the supply of the Bus Terminal electronics.

5.2.3 Positioning of passive Terminals

Hint for positioning of passive terminals in the bus terminal block

i EtherCAT Terminals (ELxxxx / ESxxxx), which do not take an active part in data transfer within the bus terminal block are so called passive terminals. The passive terminals have no current consumption out of the E-Bus.
 To ensure an optimal data transfer, you must not directly string together more than two passive terminals!

Examples for positioning of passive terminals (highlighted)

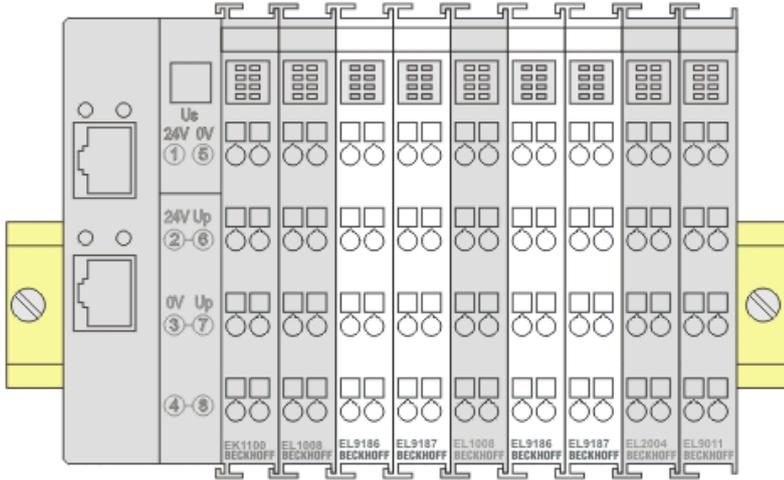

Fig. 7: Correct positioning

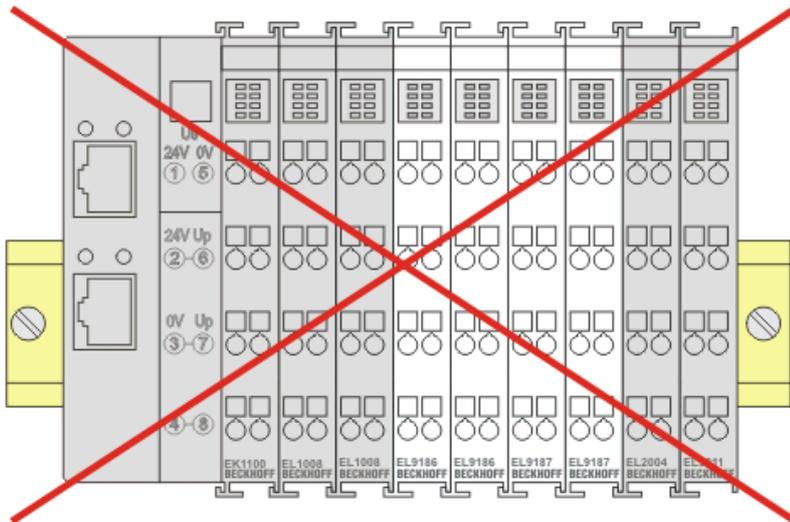

Fig. 8: Incorrect positioning

5.3 Shielding concept, grounding

5.3.1 Shield connection for OCT motor cables



The shield connection for the OCT motor cables is included in the scope of delivery and is mounted on the underside of the ELM72xx housing. If lost, the shielding bracket can be reordered separately:

- ZS5300-0015 | Shielding bracket for EtherCAT connection of ELM721x/ELM722x EtherCAT Terminals
<https://www.beckhoff.com/de-de/produkte/i-o/zubehoer/weiteres-zubehoer/montage/zs5300-0015.html>
- ZS5300-0016 | Shielding bracket for EtherCAT connection of ELM723x EtherCAT Terminals
<https://www.beckhoff.com/de-de/produkte/i-o/zubehoer/weiteres-zubehoer/montage/zs5300-0016.html>

The shield connection is used to ground electrical interference signals arriving via the motor cable shield at the housing with low resistance. The fault signals are then directed to the DIN rail via the metallic ELM housing and the integrated grounding springs. For this to work, the DIN rail/control cabinet also has to have a low-resistance connection, of course.

Note: Electrical faults usually occur in the form of high-frequency signals. Therefore, it is important to not only ensure a good low-resistance connection for DC signals (continuity test with a multimeter), but also to ensure its effectiveness for high-frequency signals in the form of a low-impedance connection. This should be tested with special measuring devices, unless the general installation instructions regarding EMC-compliant control cabinet construction are observed.

The shield connection should be used as follows:

- Attach the shield connection with the screw provided. Clean the contact surfaces, as appropriate. The second screw hole remains free in case a PE connection is required.
- Connect the individual wires of the OCT motor cable to the push-in connector provided. It should be noted that the feedback lines are twisted.
- Plug the push-in connector onto the base strip X002 or X003 and tighten the screws of the screw flange with a screwdriver.
- Press the cable shield onto the shield connector with your thumbs

Note: the shield connection does not act as strain relief!

5.3.2 Shield connection for additional signals

The following accessories can be used to connect additional shield connections or interference-sensitive signals:

- Beckhoff shielding connection system ZB8500 <https://www.beckhoff.de/zb8500/>



- Separate shield connection depending on requirements

5.4 Notes on current measurements using Hall sensors

The device described in this documentation features one or several integrated Hall sensor for the purpose of current measurements.

During this process, the Hall sensor monitors the magnetic field generated by a current flowing through a conductor.

In order to prevent compromising the measurement we recommend screening exterior magnetic fields from the device, or to keep such fields at an adequate distance.



Fig. 9: Note

5.5 Connection system / wiring

5.5.1 EMC measures

Follow these recommendations to best avoid electromagnetic interference.

- Twist the conductors of the signals "Feedback+" and "Feedback-" together.
- Ground the cable shield. See chapter [Shielding concept, grounding](#) [► 29].
- Keep individual wires as short as possible.

5.5.2 Wiring push-in connector

NOTICE

Do not wire when live.

Risk of defect.

- Only connect the conductor when it is de-energized.
- Only plug in the push-in connector when it is de-energized.

The push-in connectors X001, X002 and X003 are pluggable. X004 is firmly connected to the terminal.

All connections support push-in wiring. The wiring procedure depends on the type of conductor and connector selection:

Single wires

1. Strip 10 mm of insulation from the end of the conductor.
2. Insert the conductor into the push-in spring connection.

Stranded or fine-stranded conductors without ferrules

1. Strip 10 mm of insulation from the end of the conductor.
2. Press the latch with a screwdriver.
3. Insert wire.
4. Relieve latch.

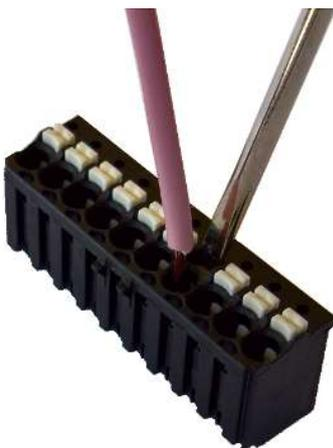

Stranded wire conductors and ferrules

Insert the wire end ferrule into the push-in spring connection.

The specified wire cross-sections refer to the technical properties of the push-in connectors. The selected cross-section must comply with the valid standard for the application in terms of minimum cross-section and electrical conductivity.

Possible conductor cross-sections depending on the type of cable:

For push-in connectors with 2x5 (X001) or 2x4 positions (X002 / X003 for ELM721x / ELM722x):

Wire cross-section AWG:	24 ... 16
Single wires:	0.2 ... 1.5 mm ²
Stranded or fine-stranded conductors without ferrules:	0.2 ... 1.5 mm ²
Stranded wire conductors with ferrule without insulating collar:	0.25 ... 1.5 mm ²
Sleeve length of the ferrules (according to DIN 46228-1):	
Cross-section 0.25 ... 0.34 mm ² :	7 mm
Cross-section 0.5 ... 1 mm ² :	8 ... 10 mm
Cross-section 1.5 mm ² :	10 mm
Stranded wire conductors with ferrule with insulating collar:	0.25 ... 0.75 mm ²
Sleeve length of the ferrules (according to DIN 46228-4):	
Cross-section 0.25 ... 0.5 mm ² :	8 ... 10 mm
Cross-section 0.75 mm ² :	10 mm

For push-in connectors with 1x8 positions (X002 for ELM723x)

Wire cross-section AWG:	24 ... 12
Single wires:	0.2 ... 2.5 mm ²
Stranded or fine-stranded conductors without ferrules:	0.2 ... 2.5 mm ²
Stranded wire conductors with ferrule without insulating collar:	0.25 ... 2.5 mm ²
Sleeve length of the ferrules (according to DIN 46228-1):	
Cross-section 0.5 ... 1.5 mm ² :	8 ... 10 mm
Cross-section 2.5 mm ² :	10 mm
Stranded wire conductors with ferrule with insulating collar:	0.25 ... 2.5 mm ²
Sleeve length of the ferrules (according to DIN 46228-4):	
Cross-section 0.5 ... 1.5 mm ² :	8 ... 10 mm
Cross-section 2.5 mm ² :	10 mm

For push-in female connector (X004):

Wire cross-section AWG:	24 ... 12
Single wires:	0.5 ... 4 mm ²
Stranded or fine-stranded conductors without ferrules:	0.2 ... 4 mm ²
Stranded wire conductors with ferrule without insulating collar:	0.25 ... 2.5 mm ²
Sleeve length of the ferrules (according to DIN 46228-1):	10 mm
Stranded wire conductors with ferrule with insulating collar:	0.25 ... 2.5 mm ²
Sleeve length of the ferrules (according to DIN 46228-4):	10 mm

6 Technical information

6.1 Functional technology

6.1.1 Servomotor

Servomotor

The servomotor is an electrical motor. Together with a servo amplifier the servomotor forms a servo drive. The servomotor is operated in a closed control loop with position, torque or speed control.

The terminals ELM72xx support control of permanent magnet synchronous motors. These consist of 3 coils which are offset by 120° and a permanent magnet rotor.

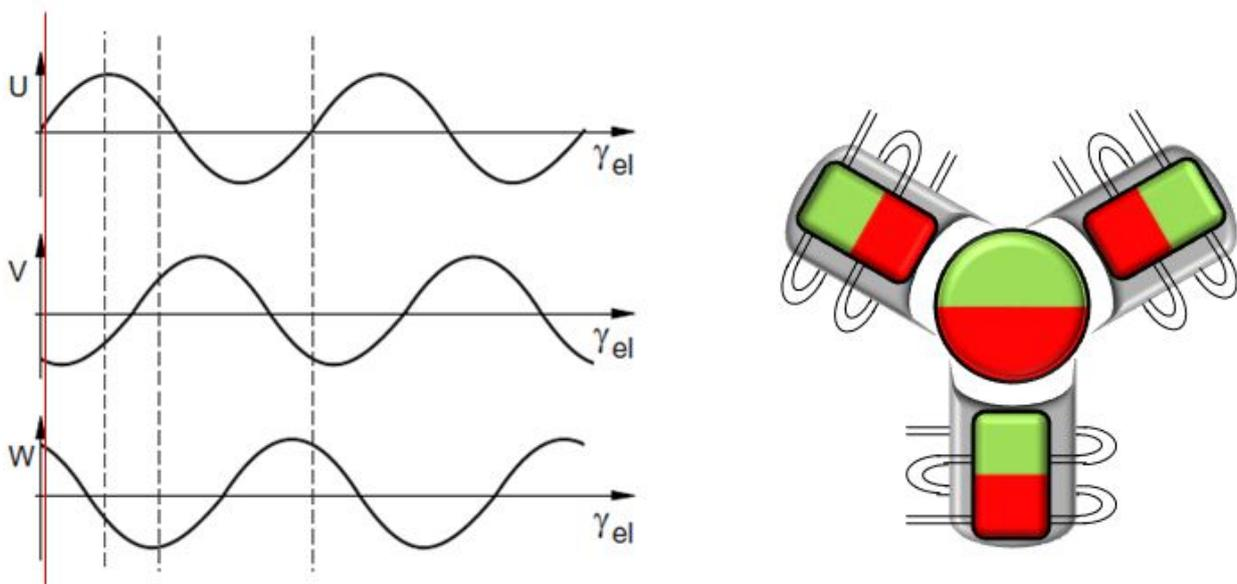

Fig. 10: Three synchronous motor coils, each offset by 120°

Servomotors particularly demonstrate their advantages in highly dynamic and precise positioning applications:

- very high positioning accuracy in applications where maximum precision is required through integrated position feedback
- high efficiency and high acceleration capacity
- servomotors are overload-proof and therefore have far greater dynamics than stepper motors, for example.
- load-independent high torque right up to the higher speed ranges
- maintenance requirements reduced to a minimum

7 Short guide to commissioning

This Quick Start Guide describes the basic commissioning of an ELM72xx in TwinCAT 3 with Drive Manager 2.

The Quick Start Guide does not claim to be complete.

For two-channel ELM72x2 terminals only the commissioning of the first channel is described.

Each chapter builds on the previous chapter. Proceed step by step in the given order.

7.1 Requirements

NOTICE

AA3100: No protection of end positions with outdated software

The automatic protection of the end positions of the AA3100 electric cylinder requires the following software version of the TE5950 | TwinCAT 3 Drive Manager 2: Version 1.1.44.0 or higher.

If an older version is used, the end positions of the AA3100 are not protected and material damage is possible.

- Check Drive Manager 2 version and update if necessary.

Make sure that the following software is installed:

- TwinCAT from version 3.1.4024.10. [Download](#)
- TE5950 | TwinCAT 3 Drive Manager 2 from version 1.1.31.30. [Download](#)

7.2 Wiring

Procedure for wiring the motor and terminal:

1. Ensure that the supply voltages and the DC link voltage are switched off
2. Connect the motor to connector X002
See chapter [Connection](#) [▶ 12]
3. Connect the DC link voltage to connector X004
See chapter [Connection](#) [▶ 12]
4. Connect the supply voltages U_s and U_p to the bus coupler / EtherCAT coupler
5. Switch on the supply voltages and the DC link voltage
6. Check the wiring using the status LEDs. The target state is as follows:
"48V" lights up green
"Up" lights up green

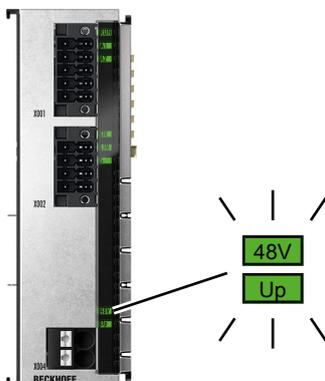

7.3 Integrating into a TwinCAT project

1. Include ELM72xx in the I/O configuration of a TwinCAT project. Optional scanning or manual
 ⇒ In the course of the integration, a dialog box appears:

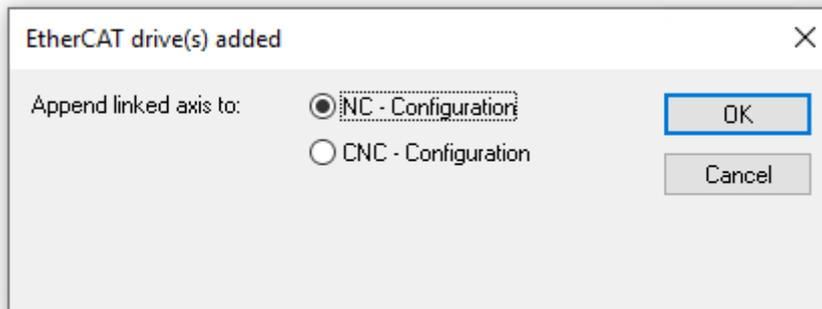

2. Select "NC - Configuration" and click on "OK"

⇒ The ELM72xx is integrated in the I/O configuration and in the NC configuration of your TwinCAT project

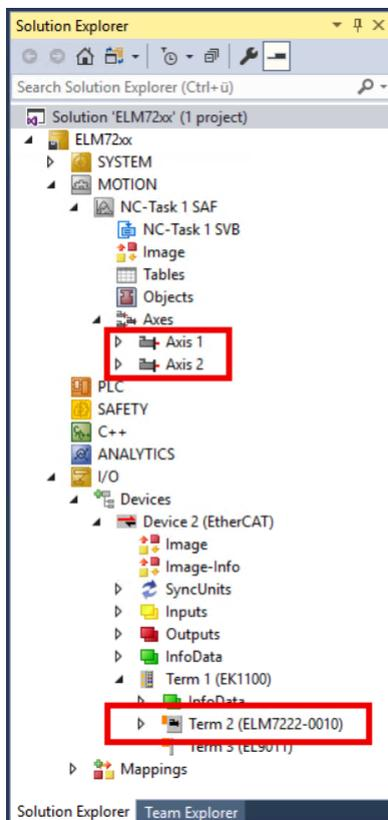

NOTICE

The internal memory may contain incorrectly set parameters

Risk of defect.

- Before commissioning, reset the terminal to the factory settings. See chapter [Restoring the delivery state](#) [▶ 49].

7.4 Configuration using the Drive Manager 2

The Drive Manager 2 is a tool for commissioning drive axes in TwinCAT 3. Further information can be found here:

- [Drive Manager 2 product page](#)
- [TwinCAT 3 Drive Manager 2 - Short commissioning.](#)

7.4.1 Creating a Drive Manager 2 project

Proceed as follows to create the project:

1. In TwinCAT select the menu item File > Add > New Project
⇒ A dialog box opens.
2. In the dialog box on the left side "Installed" > "TwinCAT Drive Manager 2" select and click OK

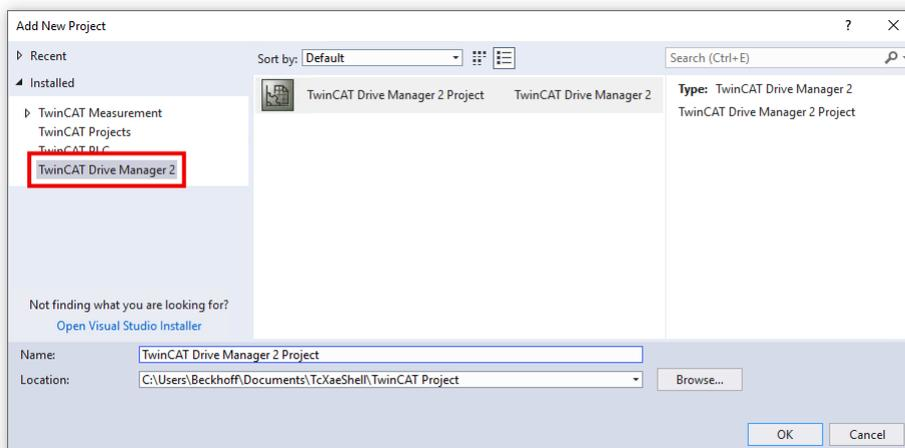

⇒ If the TwinCAT project contains several EtherCAT masters, the following dialog box appears:

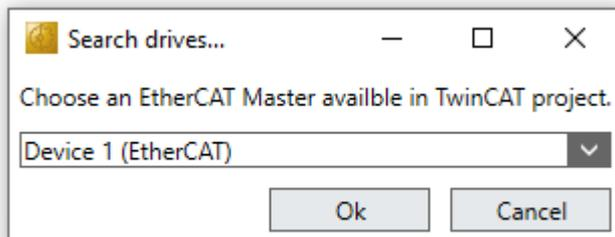

Select the EtherCAT master to which the ELM72xx is connected

- ⇒ A dialog box opens.
The following figure shows the dialog box for an ELM72x2 with two channels.

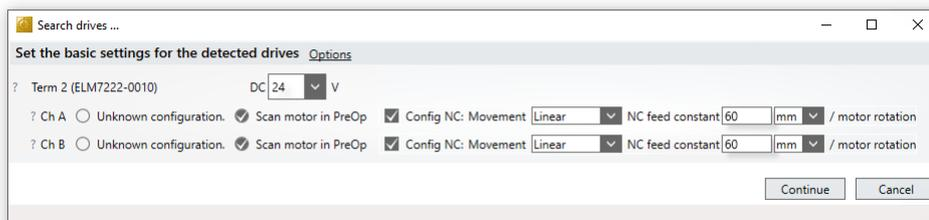

3. Set the DC link voltage that you have applied to terminal X004

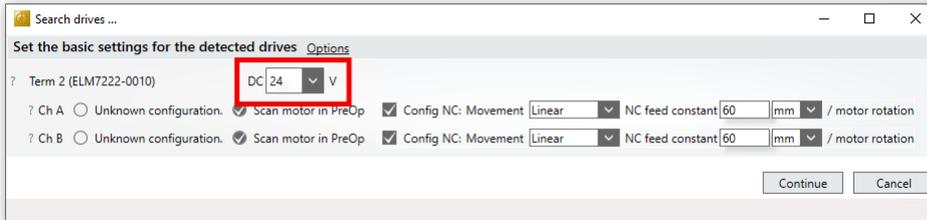

4. Make sure that "Scan motor in PreOp" is selected

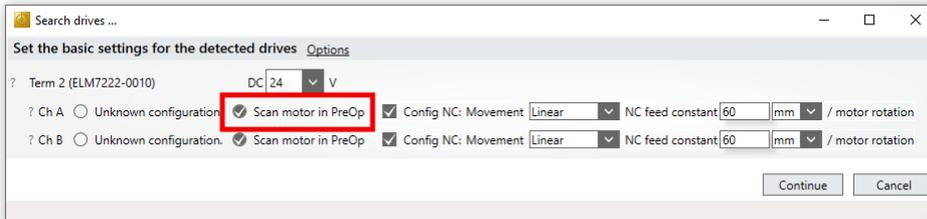

5. Set the type of movement on the output drive

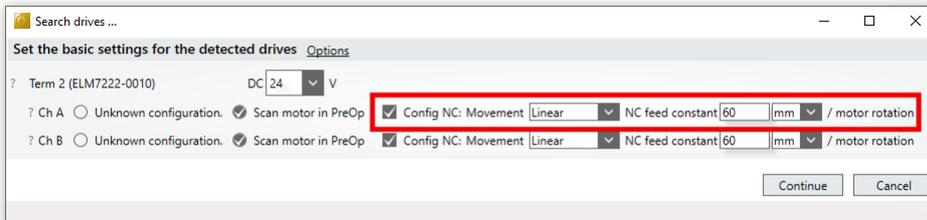

Recommendation: disconnect the motor from the connected mechanics for commissioning. In that case "Movement" = "Rotatory" and the "NC feed constant" is 360° / motor rotation. Otherwise see chapter [The "NC Feed constant" parameter](#) [► 55].

6. Click on "Continue"

⇒ ELM72xx searches for connected motors.

7. Wait for the result

⇒ A dialog box opens. It shows the result of the search.

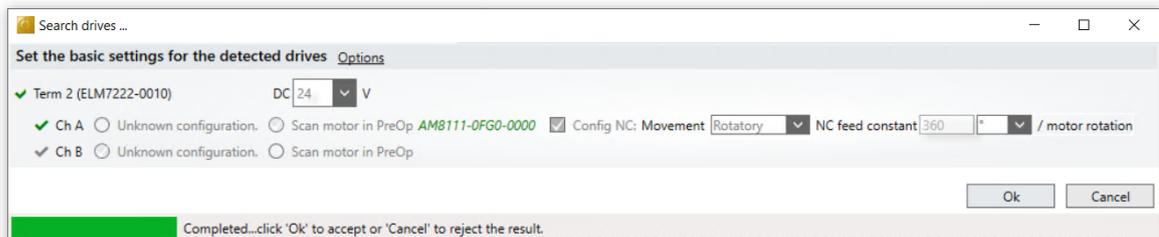

8. Click on "OK"

⇒ The electronic identification plate of the connected motor and feedback system is read out.

⇒ The data from the electronic identification plate are written to the corresponding parameters of the ELM72xx.

⇒ The project was created.

⇒ The ELM72xx and the motor were integrated into the project.

7.4.2 Setting basic parameters

1. In the Solution Explorer expand the tree under the "Drive Manager 2 Project"
2. Double click on "Ch A"

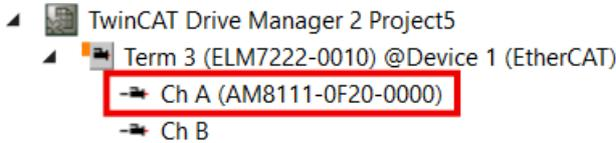

⇒ The Drive Manager 2 opens.

3. Select the menu "Basic Settings" and open the menu item "Load"

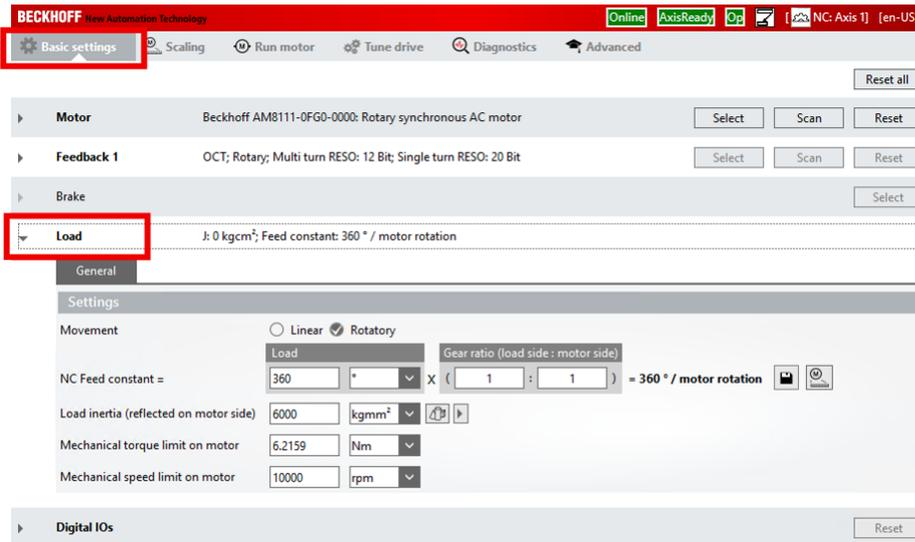

⇒ The following parameters can be specified here:

NC Feed constant

This parameter has already been set in the chapter [Creating a Drive Manager 2 project](#) [▶ 37].

Load inertia (reflected on motor side)

If you know the moment of inertia of the load, proceed as follows:

1. Enter the moment of inertia
Tip: if you are using a gear unit, use the moment of inertia calculator:

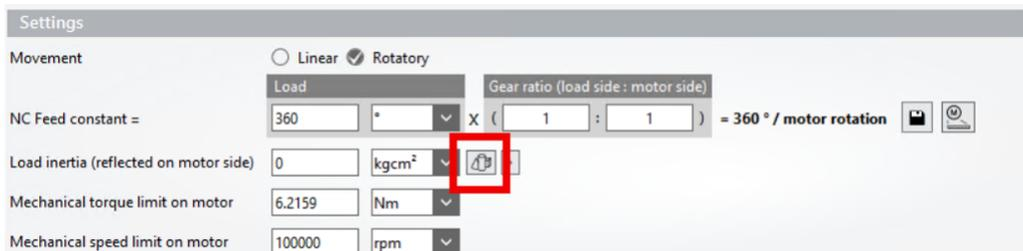

2. Confirm the entry with [Enter]
⇒ A button appears: "Recalculate VCtrl Kp and reset Tn".
3. Click on the button "Recalculate VCtrl Kp and reset Tn"
⇒ The Drive Manager 2 calculates suitable controller parameters for the speed controller.

Mechanical torque limit on motor

This value is the upper limit for the motor shaft torque. Set the value according to the requirements of the application.

Note: If you use a gear unit, the torque at the output of the gear unit may be higher than at the motor shaft.

Mechanical speed limit on motor

This value is the upper limit for the speed of the motor shaft. Set the value according to the requirements of the application.

Note: If you use a gear unit, the speed at the output of the gear unit may be higher than at the motor shaft.

i Transfer parameters to the NC

Once the parameters have been set, they must be transferred to TwinCAT NC. In this "Quick Start Guide to Commissioning", this is done in the next step "[Test run \[▶ 41\]](#)" by enabling the TwinCAT configuration.

7.5 Test run

⚠ WARNING

Danger due to movements of the motor

The motor moves during the test run.

Serious injuries and property damage are possible.

- Make sure that all parameters are set correctly.
- Ensure that the drive can move as required without endangering persons or the plant.

7.5.1 Preparation

1. Activate the TwinCAT configuration



⇒ A dialog box appears.

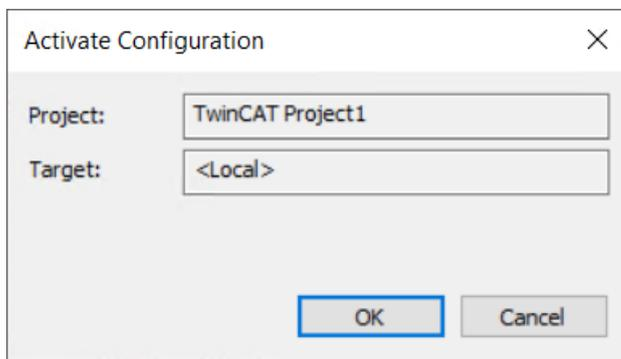

2. Confirm with OK

⇒ A dialog box appears.

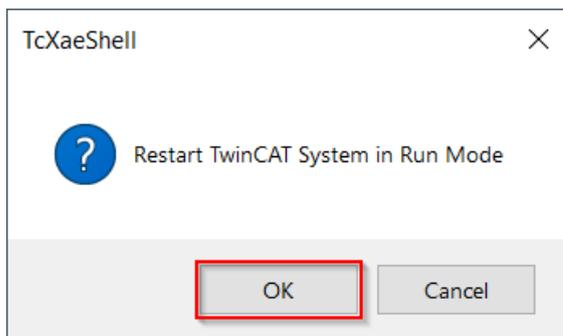

3. Confirm with OK

4. Double-click "Ch A" in the Solution Explorer

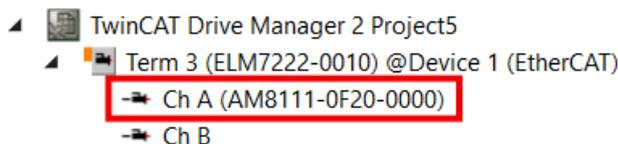

5. Select the menu "Run motor"

⇒ A warning message appears.

6. Read and follow the warning

7. Acknowledge the warning message by clicking "OK"

If "OK" cannot be clicked, the Drive Manager 2 will display the reason in blue letters.

⇒ The "Run Motor" window appears.

8. Click on the button "Start record"

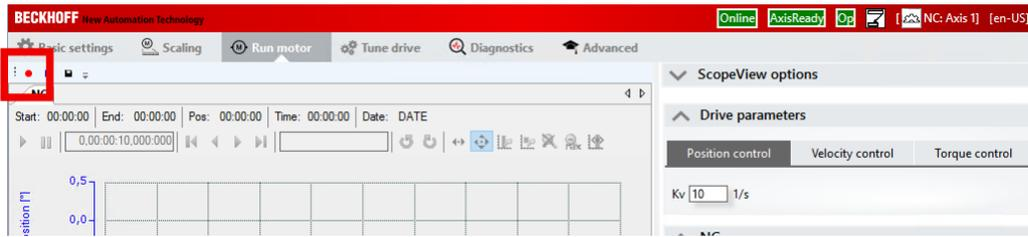

⇒ The Scope View records position, speed and following error.

7.5.2 Axis enable

The axis only executes motion commands when it is enabled. Enable the axis as follows:

1. Check whether the icons "Online", "AxisReady" and "Op" are in the title bar of Drive Manager 2 and whether they are highlighted in green

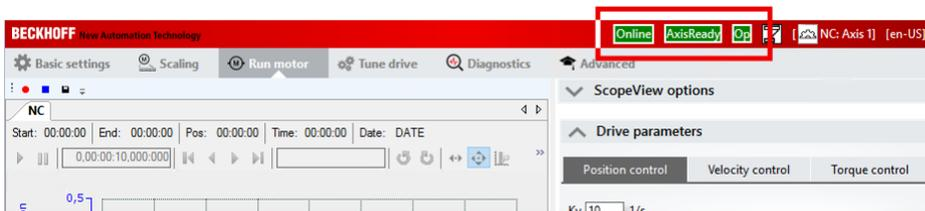

⇒ If yes: the Drive Manager 2 is ready.

2. On the right side under "NC" activate the checkbox "Enable controller"

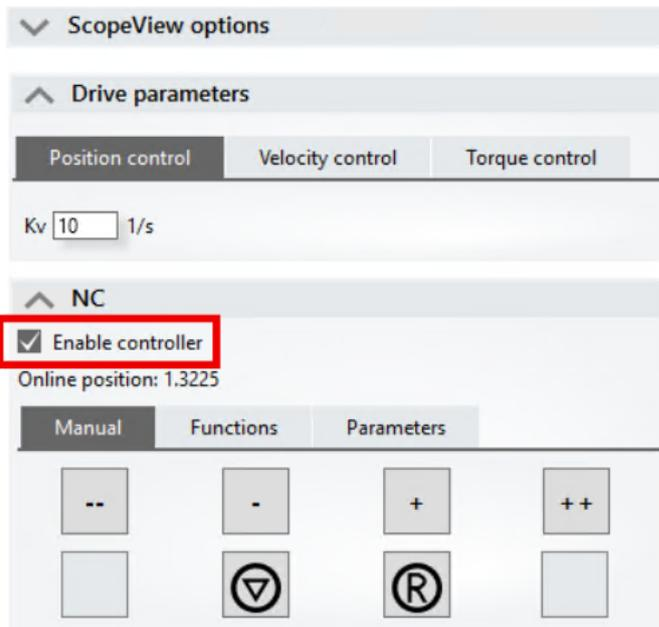

⇒ The axis is enabled.

⇒ At the housing of the ELM72xx the LED "OK" next to X002 is green.

7.5.3 Manual operation

You can move the motor as you wish in manual mode.

The controls for manual operation are located on the right side of the window under "NC" > "Manual".

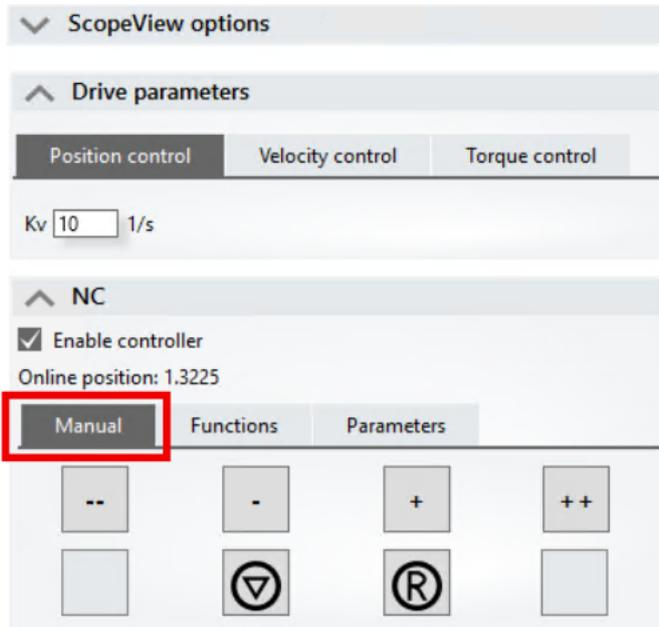

The following buttons are available:

Button	Explanation
-	Travel in the negative direction at 5% of the maximum velocity.
--	Travel in the negative direction at 30% of the maximum velocity.
+	Travel in the positive direction at 5% of the maximum velocity.
++	Travel in the positive direction at 30% of the maximum velocity.
▽	Stop the NC axis
R	Reset an error from the Motion NC

The motor only runs as long as a button is pressed. As soon as you release the mouse button, the motor stops.

● Behavior in case of an error

i If an error occurs, the following symbol appears in the user interface:



- Move the mouse cursor over the symbol to get more information about the error.
- Click the "R" button to acknowledge all errors.
If the error cannot be acknowledged, check the messages in the tab "Diagnostics".

7.5.3.1 Dynamics

The acceleration time is set quite high in the factory setting. The motor accelerates only slowly.

You can set the acceleration time at "Parameters":

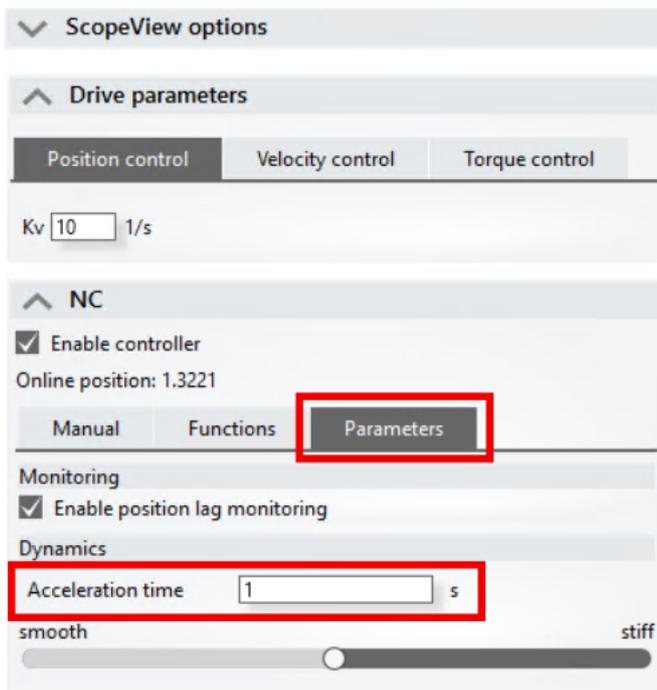

Lower acceleration time increases the probability that a following error will occur. If necessary, increase the permissible following error. See chapter [CSP](#) | 51].

7.6 Controller optimization

You can display the controller structure in Drive Manager 2 by selecting the "Tune Drive" menu. Click on individual elements in the controller structure to display their internal structure.

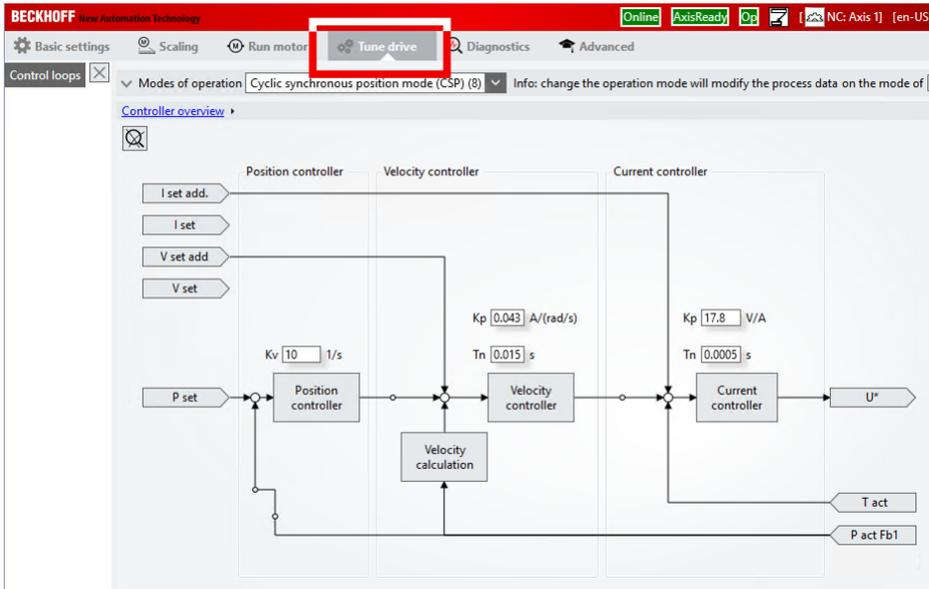

The CSP operation mode is set in the factory settings. Three controllers are active in this operation mode:

- Current controller
- Velocity controller
- Position controller

The following chapters describe the optimization of the individual controllers in the CSP operation mode.

Further information on the operation modes can be found in chapter [Controller operation mode](#) [► 51].

7.6.1 Optimization of the current controller

The current controller does not usually need to be optimized.

The controller parameters of the current controller are determined on the basis of the technical data of the motor. Therefore, the controller parameters are usually set sufficiently well by reading the electronic identification plate.

7.6.2 Optimization of the speed controller

The speed controller is a PI controller.

The following parameters are optimized in this chapter:

- The integral component T_n
- The proportional component K_p .

Preparation

1. Open the "Run motor" menu
2. Click on the button "Start record"

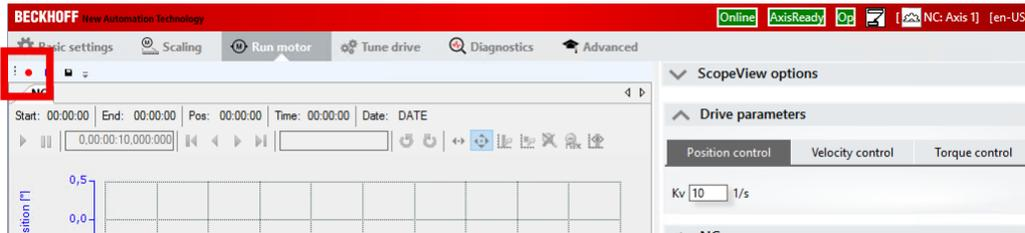

⇒ The Scope View records position, speed and following error.

3. Under "NC": select "Functions"
4. In the field "Start mode" select the entry "Reversing sequence"
5. Enter realistic values in the following fields:
 - Target position 1
 - Target velocity
 - Target position 2
6. Click on the button "Start"
 - ⇒ The motor performs the set movement periodically.
7. If necessary, reduce the acceleration time
 - See chapter [Dynamics](#) [▶ 43].
8. Under "Drive Parameters" select the tab "Velocity control"
 - ⇒ Here you can set the controller parameters of the speed controller.

Optimization of the integral component T_n

1. Reduce the T_n value step by step
 - Confirm each entry with [Ctrl] + [Enter]
 - Meanwhile, observe the Scope View
 - ⇒ At a certain value of T_n , the motor starts to oscillate.
 - Example without oscillation:

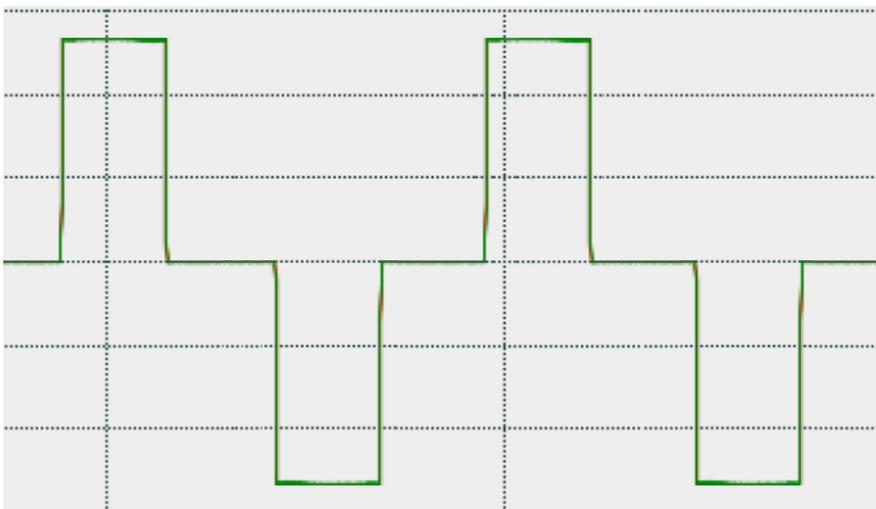

Example with oscillation:

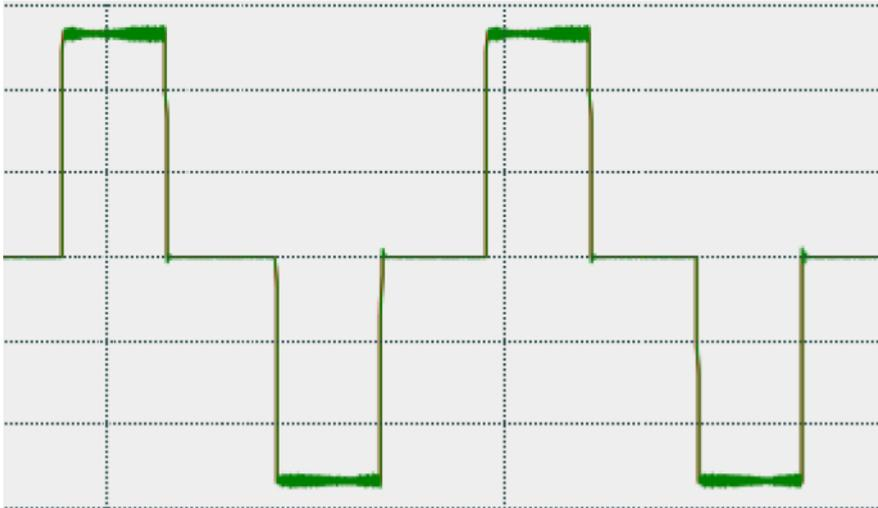

From here on, do not reduce the T_n value any further.

2. Increase T_n again until the motor no longer oscillates
 3. Increase T_n a bit more
Depending on the application.
- ⇒ The integral component T_n is optimized.

Optimization of the proportional component K_p

The optimization of K_p is analogous to the optimization of T_n . However, you do not have to reduce K_p , but increase it.

1. Increase the K_p value step by step
Confirm each entry with [Ctrl] + [Enter]
Meanwhile, observe the Scope View
⇒ At a certain value of T_n , the motor starts to oscillate. See above.
2. Reduce K_p again until the motor no longer oscillates
3. Still reduce K_p a little. Depending on the application

7.6.3 Optimization of the position controller

The position controller is a P-controller.

Optimization of the proportional component Kv

The optimization of the proportional component is analogous to the optimization of the proportional component of the speed controller.

1. Under "Drive Parameters" select the tab "Position"
2. Increase the Kv value step by step
Meanwhile, watch the Scope View
⇒ At a certain value of Kv the motor starts to oscillate
3. Reduce Kv again until the motor no longer oscillates
4. Reduce Kv a bit more
Depending on the application.
⇒ The position controller is optimized.

Velocity pre-control

The velocity pre-control improves the control behavior especially during acceleration and braking.

It routes part of the position setpoint past the position controller and directly to the speed controller.

1. Select the menu "Tune Drive"
2. Click on the "Position Controller" in the controller structure
3. Set the parameter K in the "Feed forward velocity" field

8 Commissioning

8.1 Restoring the delivery state

To restore the delivery state (factory settings) of CoE objects for EtherCAT devices (“slaves”), the CoE object *Restore default parameters*, SubIndex 001 can be used via EtherCAT master (e.g. TwinCAT) (see Fig. *Selecting the Restore default parameters PDO*).

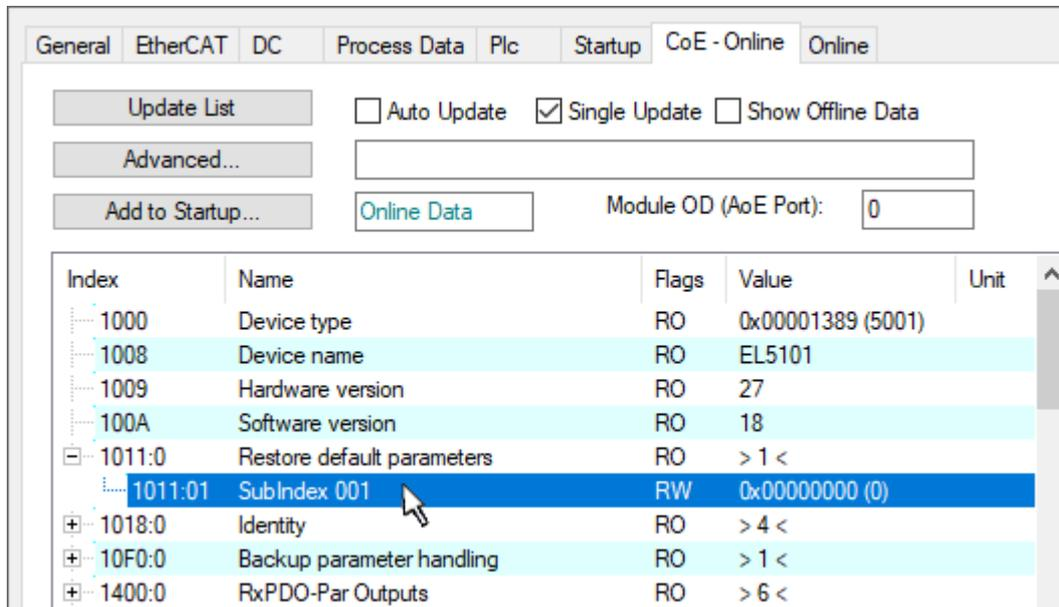

Fig. 11: Selecting the *Restore default parameters* PDO

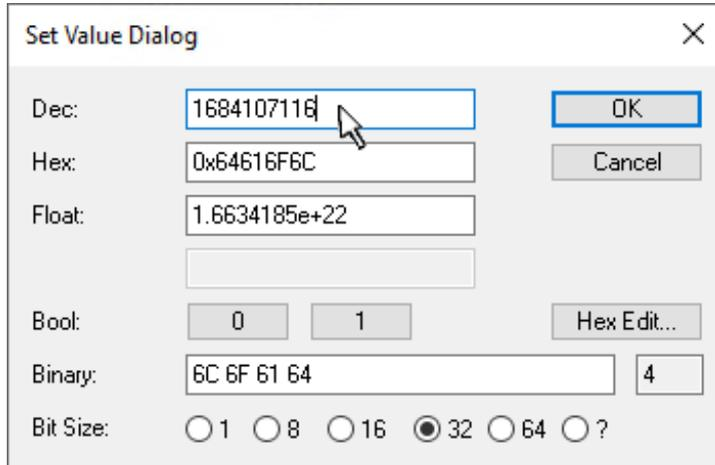

Fig. 12: Entering a restore value in the Set Value dialog

Double-click on *SubIndex 001* to enter the Set Value dialog. Enter the reset value **1684107116** in field *Dec* or the value **0x64616F6C** in field *Hex* (ASCII: “load”) and confirm with *OK* (Fig. *Entering a restore value in the Set Value dialog*).

- All changeable entries in the slave are reset to the default values.
- The values can only be successfully restored if the reset is directly applied to the online CoE, i.e. to the slave. No values can be changed in the offline CoE.
- TwinCAT must be in the RUN or CONFIG/Freerun state for this; that means EtherCAT data exchange takes place. Ensure error-free EtherCAT transmission.
- No separate confirmation takes place due to the reset. A changeable object can be manipulated beforehand for the purposes of checking.

- This reset procedure can also be adopted as the first entry in the startup list of the slave, e.g. in the state transition PREOP->SAFEOP or, as in Fig. *CoE reset as a startup entry*, in SAFEOP->OP.

All backup objects are reset to the delivery state.

i **Alternative restore value**

In some older terminals (FW creation approx. before 2007) the backup objects can be switched with an alternative restore value: Decimal value: 1819238756, Hexadecimal value: 0x6C6F6164.

An incorrect entry for the restore value has no effect.

8.2 Controller operation mode

By selecting the operation mode, you determine the controlled variable and the controller structure.

The factory setting is the operation mode CSP.

Select the operation mode according to the desired controlled variable:

Controlled variable	Operation mode
Position	CSP [▶ 51] ¹⁾
Velocity	CSV [▶ 53]
Torque	CST [▶ 53]
Torque and commutation angle	CSTCA [▶ 53]

¹⁾ You can also control the position with the CSV operation mode. See chapter [CSV \[▶ 53\]](#). The control performance is better with CSP, however.



Cycle time

For CSP, CSV, CST, and CSTCA, the cycle time must be $n * 62.5 \mu s$ (with $n = 2$ to 160), which is $125 \mu s$ to $10 ms$.

Setting the operation mode

1. In the Solution Explorer, expand the tree under the "Drive Manager 2 Project".

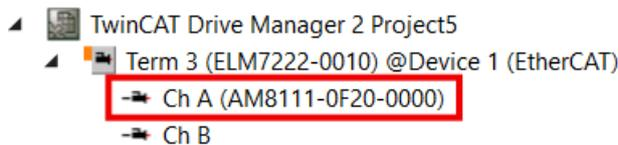

2. Double-click Ch A.
 - ⇒ The Drive Manager 2 opens.
3. Select the menu "Tune drive".
4. Set the operation mode in the drop-down menu "Modes of operation".
 - ⇒ Changes are displayed in the controller structure. E.g. the position controller is disconnected when changing from CSP to CSV.

8.2.1 CSP

Position control

CSP is the abbreviation for "Cyclic synchronous position".

A defined target position can be set via the "Target position" variable.

With the settings for the CSP operation mode, the terminal internally calculates the control loops for current, velocity and position. The NC calculates the setpoint for the position and transfers it to the terminal.

Following error monitor

In the factory setting, following error monitor is active in the operation mode *CSP*. In all other operation modes the following error monitor is not used and is ignored.

- The window of the following error monitor can be adjusted with the *Following error window* (Index 0x8010:50). The value set here – multiplied by the scaling factor – specifies by what position the actual position may differ from the set position, positively and negatively. The total accepted tolerance is thus twice as large as the position entered in the *Following error window* (see fig. *Following error window*).

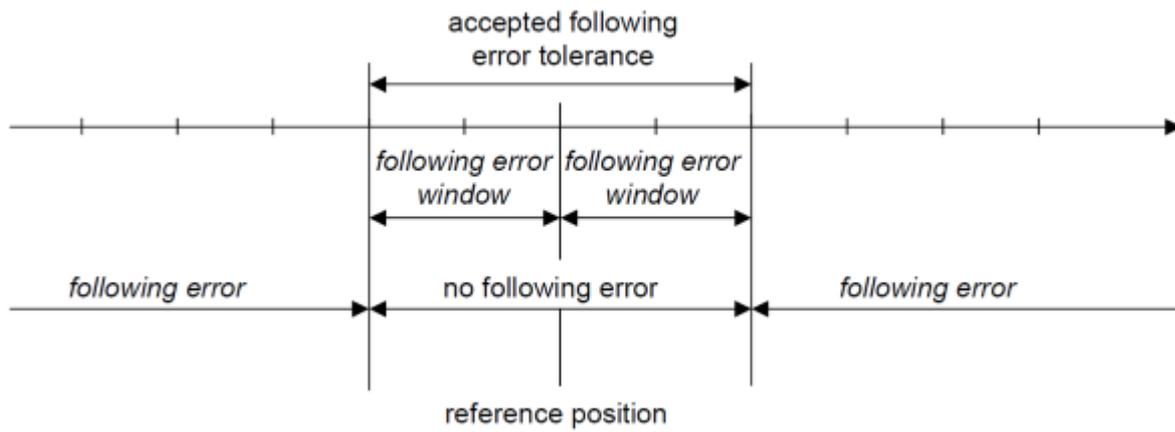

Fig. 13: Following error window

- The time (in ms) allowed for a following error timeout can be set with the *Following error time out* (Index 0x8010:51). As soon as the target position is exceeded by more than the position entered in the *Following error window* for the time entered in the *Following error time out*, the terminal outputs an error and stops immediately.
- The current following error can be read in the *Following error actual value* (Index 0x6010:06).

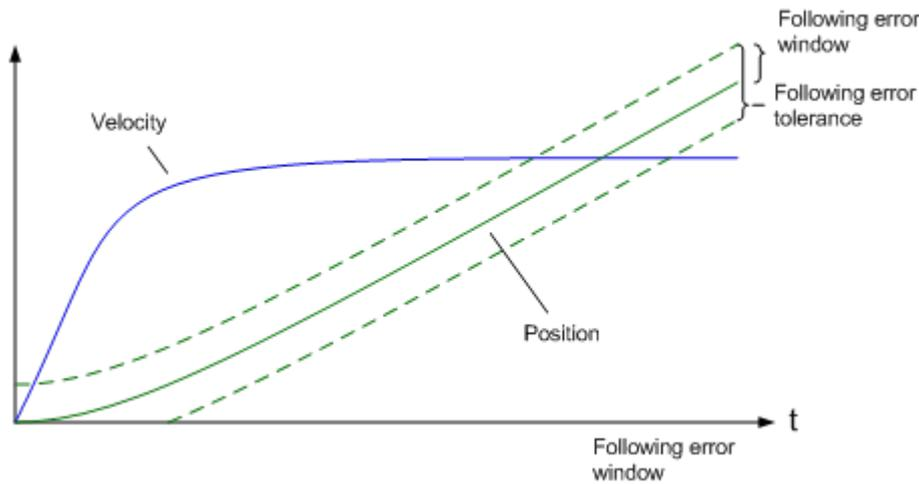

Fig. 14: Following error time out

The value 0xFFFFFFFF (-1) in the *Following error window* means that the following error monitor is switched off and corresponds to the delivery state.
 The *Following error time out* is 0x0000 (0) on delivery.

8.2.2 CSV

CSV is the abbreviation for "Cyclic synchronous velocity".

A defined velocity can be set via the "Target velocity" variable.

8.2.2.1 Position control with TwinCAT NC

With the CSV operation mode you can also control the position by using TwinCAT NC as the position controller.

In the context of positioning tasks, however, the CSP operation mode performs better as no bus dead times occur between the controllers (due to the communication between terminal and NC) and all controllers in the architecture are calculated in the same place.

8.2.3 CST (torque control)

CST is the abbreviation for "Cyclic synchronous torque".

A defined torque can be set via the "Target torque" variable. You cannot use TwinCAT NC to specify the torque.

8.2.4 CSTCA

Current control with commutation angle

CSTCA is the abbreviation for "Cyclic synchronous torque with commutation angle".

This mode is a current control similar to [CST](#) [► 53]. In addition the user can specify the commutation angle.

You cannot use TwinCAT NC to specify speed and commutation angle. The variable "Commutation angle" can be used to set an angle which is to be maintained with a defined set current of the variable "Target torque". By specifying a leading angle, a movement can be achieved in this operation mode.

8.3 Electronic identification plate of motors

The AM8100 series servomotors from Beckhoff have an electronic identification plate. The technical data of the motor and the feedback system are stored in the electronic identification plate.

The ELM72xx can read the electronic identification plate via the OCT data lines. The technical data are automatically written to the corresponding parameters of ELM72xx during this process.

- If you use the Drive Manager 2, the electronic identification plate is read out automatically.
- If you *do not* use the Drive Manager 2, you can configure the reading of the electronic identification plate according to the following flow chart:

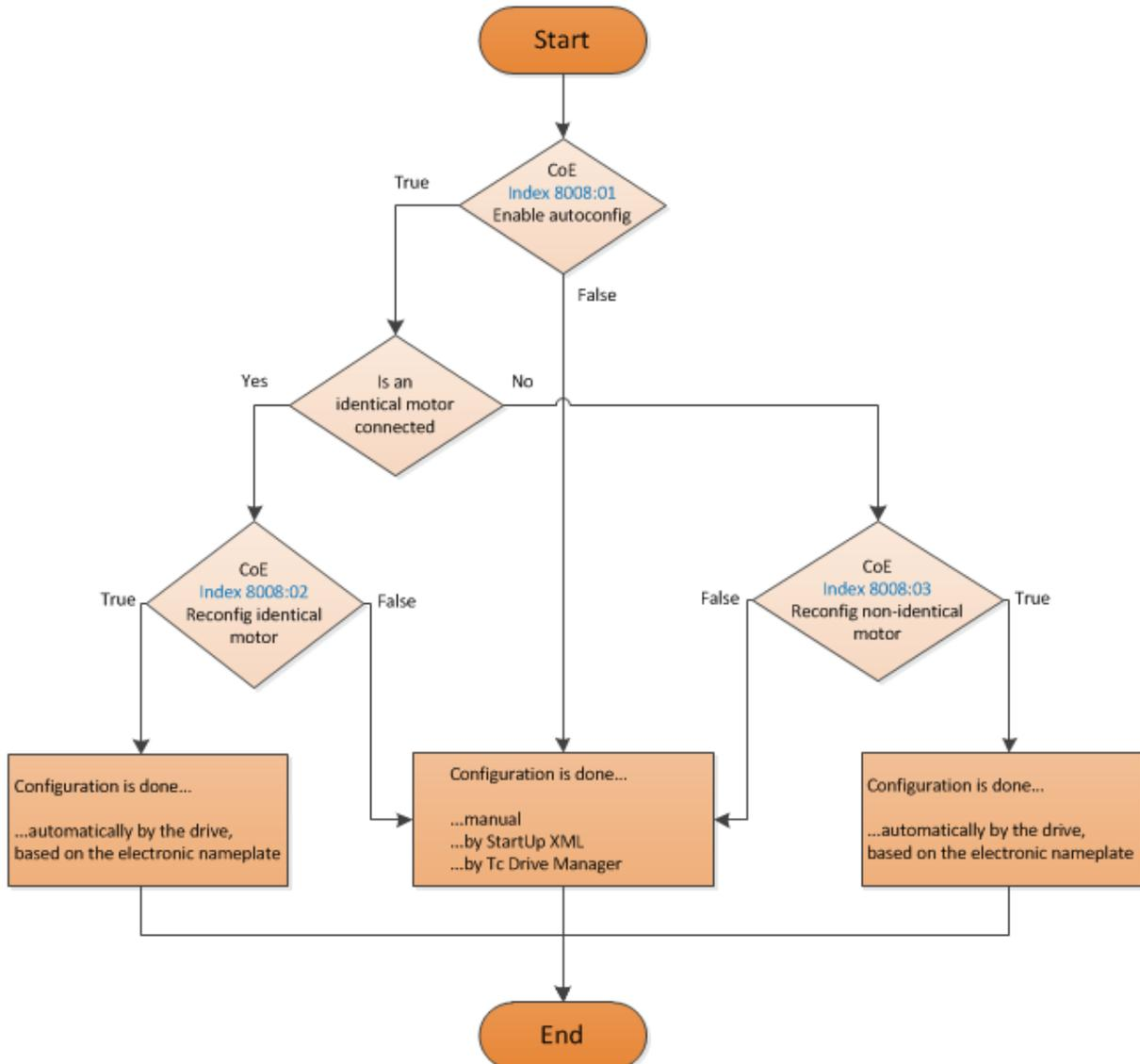

8.4 The "NC Feed constant" parameter

The NC Feed constant defines the traveled distance of the load per revolution of the motor shaft. With the NC Feed constant you can, for example, map the transmission ratio of a gear unit.

You can set the NC feed constant in the Drive Manager 2 in the menu "Basic settings" under "Load".

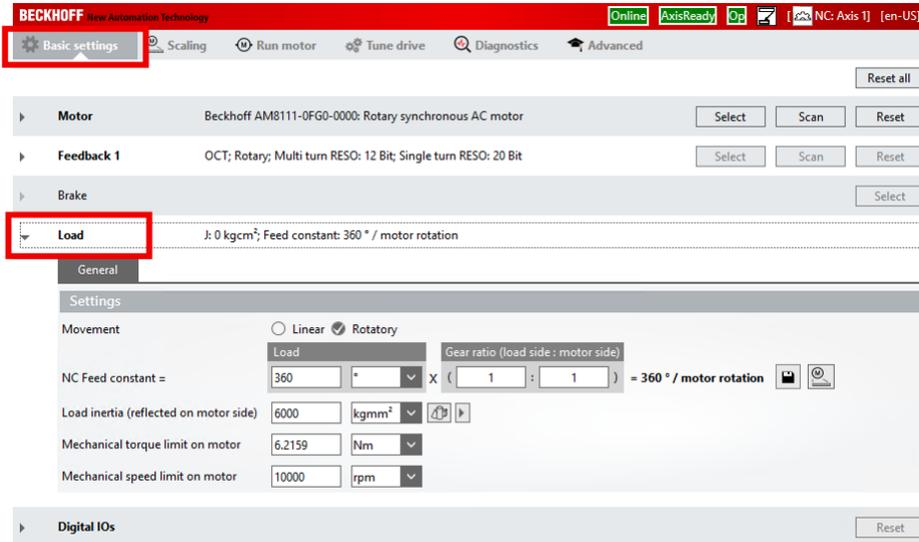

Example: Calculation for a rotary NC axis with gear unit

Given:

- A gear unit with transmission ratio $i = 10$ (reduction)

Result:

- NC feed constant = $360^\circ / i = 36^\circ$

8.5 Diagnosis

8.5.1 Diagnostics - basic principles of diag messages

DiagMessages designates a system for the transmission of messages from the EtherCAT Slave to the EtherCAT Master/TwinCAT. The messages are stored by the device in its own CoE under 0x10F3 and can be read by the application or the System Manager. An error message referenced via a code is output for each event stored in the device (warning, error, status change).

Definition

The *DiagMessages* system is defined in the ETG (EtherCAT Technology Group) in the guideline ETG.1020, chapter 13 "Diagnosis handling". It is used so that pre-defined or flexible diagnostic messages can be conveyed from the EtherCAT Slave to the Master. In accordance with the ETG, the process can therefore be implemented supplier-independently. Support is optional. The firmware can store up to 250 *DiagMessages* in its own CoE.

Each *DiagMessage* consists of

- Diag Code (4-byte)
- Flags (2-byte; info, warning or error)
- Text ID (2-byte; reference to explanatory text from the ESI/XML)
- Timestamp (8-byte, local slave time or 64-bit Distributed Clock time, if available)
- Dynamic parameters added by the firmware

The *DiagMessages* are explained in text form in the ESI/XML file belonging to the EtherCAT device: on the basis of the Text ID contained in the *DiagMessage*, the corresponding plain text message can be found in the languages contained in the ESI/XML. In the case of Beckhoff products these are usually German and English.

Via the entry *NewMessagesAvailable* the user receives information that new messages are available.

DiagMessages can be confirmed in the device: the last/latest unconfirmed message can be confirmed by the user.

In the CoE both the control entries and the history itself can be found in the CoE object 0x10F3:

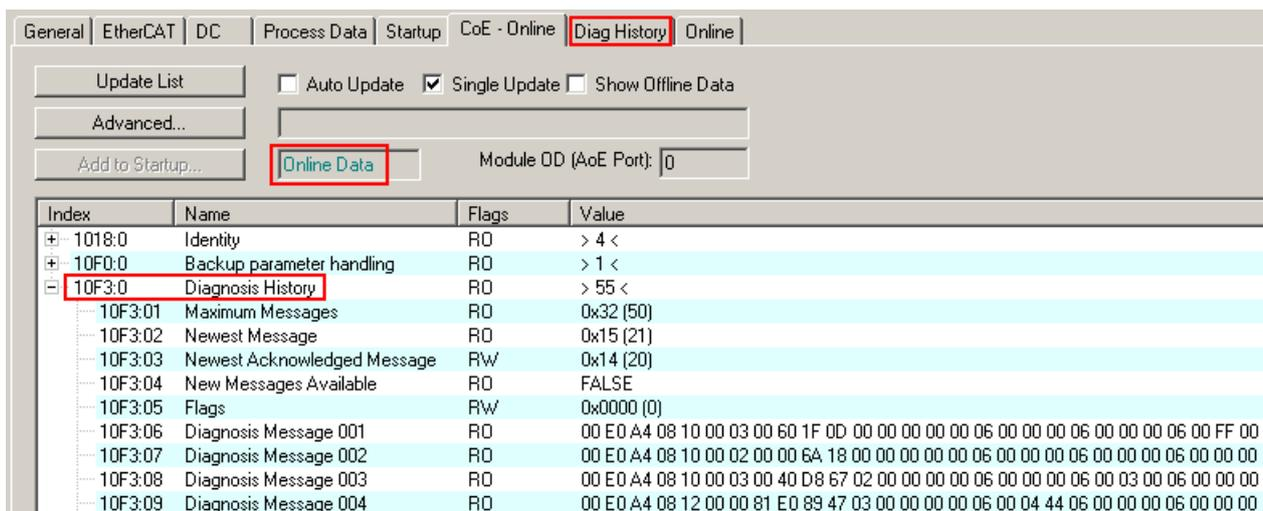

Index	Name	Flags	Value
1018:0	Identity	RO	> 4 <
10F0:0	Backup parameter handling	RO	> 1 <
10F3:0	Diagnosis History	RO	> 55 <
10F3:01	Maximum Messages	RO	0x32 (50)
10F3:02	Newest Message	RO	0x15 (21)
10F3:03	Newest Acknowledged Message	RW	0x14 (20)
10F3:04	New Messages Available	RO	FALSE
10F3:05	Flags	RW	0x0000 (0)
10F3:06	Diagnosis Message 001	RO	00 E0 A4 08 10 00 03 00 60 1F 0D 00 00 00 00 00 06 00 00 00 06 00 00 00 06 00 FF 00
10F3:07	Diagnosis Message 002	RO	00 E0 A4 08 10 00 02 00 00 6A 18 00 00 00 00 00 06 00 00 00 06 00 00 00 06 00 00 00
10F3:08	Diagnosis Message 003	RO	00 E0 A4 08 10 00 03 00 40 D8 67 02 00 00 00 00 06 00 00 00 06 00 03 00 06 00 00 00
10F3:09	Diagnosis Message 004	RO	00 E0 A4 08 12 00 00 81 E0 89 47 03 00 00 00 00 06 00 04 44 06 00 00 00 06 00 00 00

Fig. 15: *DiagMessages* in the CoE

The subindex of the latest *DiagMessage* can be read under 0x10F3:02.

● Support for commissioning

I The *DiagMessages* system is to be used above all during the commissioning of the plant. The diagnostic values e.g. in the StatusWord of the device (if available) are helpful for online diagnosis during the subsequent continuous operation.

TwinCAT System Manager implementation

From TwinCAT 2.11 DiagMessages, if available, are displayed in the device's own interface. Operation (collection, confirmation) also takes place via this interface.

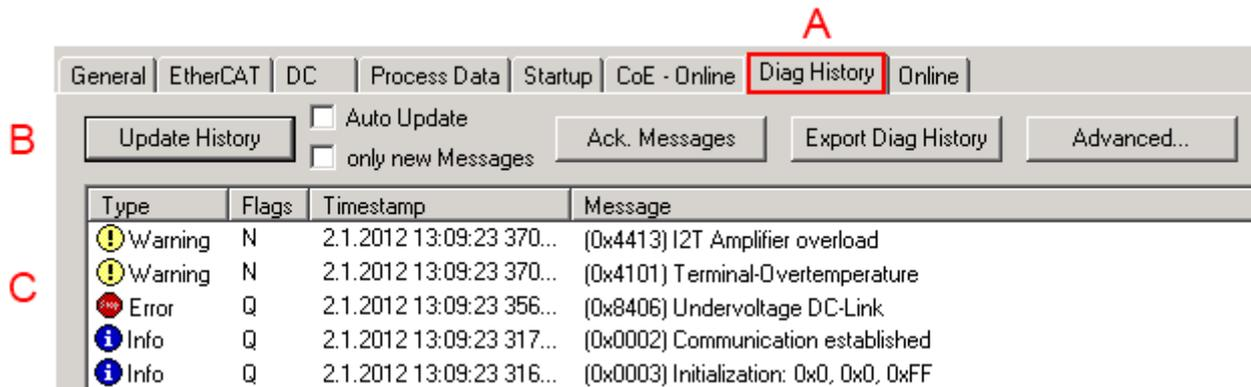

Fig. 16: Implementation of the DiagMessage system in the TwinCAT System Manager

The operating buttons (B) and the history read out (C) can be seen on the Diag History tab (A). The components of the message:

- Info/Warning/Error
- Acknowledge flag (N = unconfirmed, Q = confirmed)
- Time stamp
- Text ID
- Plain text message according to ESI/XML data

The meanings of the buttons are self-explanatory.

DiagMessages within the ADS Logger/Eventlogger

From TwinCAT 3.1 build 4022 onwards, DiagMessages sent by the terminal are shown by the TwinCAT ADS Logger. Given that DiagMessages are represented IO- comprehensive at one place, commissioning will be simplified. In addition, the logger output could be stored into a data file – hence DiagMessages are available long-term for analysis.

DiagMessages are actually only available locally in CoE 0x10F3 in the terminal and can be read out manually if required, e.g. via the DiagHistory mentioned above.

In the latest developments, the EtherCAT Terminals are set by default to report the presence of a DiagMessage as emergency via EtherCAT; the event logger can then retrieve the DiagMessage. The function is activated in the terminal via 0x10F3:05, so such terminals have the following entry in the StartUp list by default:

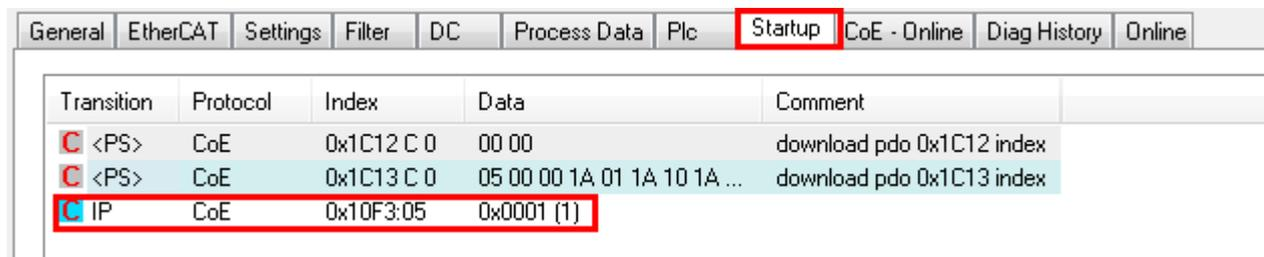

Fig. 17: Startup List

If the function is to be deactivated because, for example, many messages come in or the EventLogger is not used, the StartUp entry can be deleted or set to 0. The value can then be set back to 1 later from the PLC via CoE access if required.

Reading messages into the PLC

- In preparation -

Interpretation

Time stamp

The time stamp is obtained from the local clock of the terminal at the time of the event. The time is usually the distributed clock time (DC) from register x910.

Please note: When EtherCAT is started, the DC time in the reference clock is set to the same time as the local IPC/TwinCAT time. From this moment the DC time may differ from the IPC time, since the IPC time is not adjusted. Significant time differences may develop after several weeks of operation without a EtherCAT restart. As a remedy, external synchronization of the DC time can be used, or a manual correction calculation can be applied, as required: The current DC time can be determined via the EtherCAT master or from register x901 of the DC slave.

Structure of the Text ID

The structure of the MessageID is not subject to any standardization and can be supplier-specifically defined. In the case of Beckhoff EtherCAT devices (EL, EP) it usually reads according to **xyzz**:

x	y	zz
0: Systeminfo 2: reserved 1: Info 4: Warning 8: Error	0: System 1: General 2: Communication 3: Encoder 4: Drive 5: Inputs 6: I/O general 7: reserved	Error number

Example: Message 0x4413 --> Drive Warning Number 0x13

Overview of text IDs

Specific text IDs are listed in the device documentation.

Text ID	Type	Place	Text Message	Additional comment
0x0001	Information	System	No error	No error
0x0002	Information	System	Communication established	Connection established
0x0003	Information	System	Initialization: 0x%X, 0x%X, 0x%X	General information; parameters depend on event. See device documentation for interpretation.
0x1000	Information	System	Information: 0x%X, 0x%X, 0x%X	General information; parameters depend on event. See device documentation for interpretation.
0x1012	Information	System	EtherCAT state change Init - PreOp	
0x1021	Information	System	EtherCAT state change PreOp - Init	
0x1024	Information	System	EtherCAT state change PreOp - Safe-Op	
0x1042	Information	System	EtherCAT state change SafeOp - PreOp	
0x1048	Information	System	EtherCAT state change SafeOp - Op	
0x1084	Information	System	EtherCAT state change Op - SafeOp	
0x1100	Information	General	Detection of operation mode completed: 0x%X, %d	Detection of the mode of operation ended
0x1135	Information	General	Cycle time o.k.: %d	Cycle time OK
0x1157	Information	General	Data manually saved (Idx: 0x%X, SubIdx: 0x%X)	Data saved manually
0x1158	Information	General	Data automatically saved (Idx: 0x%X, SubIdx: 0x%X)	Data saved automatically
0x1159	Information	General	Data deleted (Idx: 0x%X, SubIdx: 0x%X)	Data deleted
0x117F	Information	General	Information: 0x%X, 0x%X, 0x%X	Information
0x1201	Information	Communication	Communication re-established	Communication to the field side restored This message appears, for example, if the voltage was removed from the power contacts and re-applied during operation.
0x1300	Information	Encoder	Position set: %d, %d	Position set - StartInputhandler
0x1303	Information	Encoder	Encoder Supply ok	Encoder power supply unit OK
0x1304	Information	Encoder	Encoder initialization successfully, channel: %X	Encoder initialization successfully completed
0x1305	Information	Encoder	Sent command encoder reset, channel: %X	Send encoder reset command
0x1400	Information	Drive	Drive is calibrated: %d, %d	Drive is calibrated
0x1401	Information	Drive	Actual drive state: 0x%X, %d	Current drive status
0x1705	Information		CPU usage returns in normal range (< 85%%)	Processor load is back in the normal range
0x1706	Information		Channel is not in saturation anymore	Channel is no longer in saturation
0x1707	Information		Channel is not in overload anymore	Channel is no longer overloaded
0x170A	Information		No channel range error anymore	A measuring range error is no longer active
0x170C	Information		Calibration data saved	Calibration data were saved
0x170D	Information		Calibration data will be applied and saved after sending the command "0x5AFE"	Calibration data are not applied and saved until the command "0x5AFE" is sent.

Text ID	Type	Place	Text Message	Additional comment
0x2000	Information	System	%s: %s	
0x2001	Information	System	%s: Network link lost	Network connection lost
0x2002	Information	System	%s: Network link detected	Network connection found
0x2003	Information	System	%s: no valid IP Configuration - Dhcp client started	Invalid IP configuration
0x2004	Information	System	%s: valid IP Configuration (IP: %d.%d.%d.%d) assigned by Dhcp server %d.%d.%d.%d	Valid IP configuration, assigned by the DHCP server
0x2005	Information	System	%s: Dhcp client timed out	DHCP client timeout
0x2006	Information	System	%s: Duplicate IP Address detected (%d.%d.%d.%d)	Duplicate IP address found
0x2007	Information	System	%s: UDP handler initialized	UDP handler initialized
0x2008	Information	System	%s: TCP handler initialized	TCP handler initialized
0x2009	Information	System	%s: No more free TCP sockets available	No free TCP sockets available.

Text ID	Type	Place	Text Message	Additional comment
0x4000	Warning		Warning: 0x%X, 0x%X, 0x%X	General warning; parameters depend on event. See device documentation for interpretation.
0x4001	Warning	System	Warning: 0x%X, 0x%X, 0x%X	
0x4002	Warning	System	%s: %s Connection Open (IN:%d OUT:%d API:%dms) from %d. %d.%d.%d successful	
0x4003	Warning	System	%s: %s Connection Close (IN:%d OUT:%d) from %d.%d.%d.%d successful	
0x4004	Warning	System	%s: %s Connection (IN:%d OUT:%d) with %d.%d.%d.%d timed out	
0x4005	Warning	System	%s: %s Connection Open (IN:%d OUT:%d) from %d.%d.%d.%d denied (Error: %u)	
0x4006	Warning	System	%s: %s Connection Open (IN:%d OUT:%d) from %d.%d.%d.%d denied (Input Data Size expected: %d Byte(s) received: %d Byte(s))	
0x4007	Warning	System	%s: %s Connection Open (IN:%d OUT:%d) from %d.%d.%d.%d denied (Output Data Size expected: %d Byte(s) received: %d Byte(s))	
0x4008	Warning	System	%s: %s Connection Open (IN:%d OUT:%d) from %d.%d.%d.%d denied (RPI:%dms not supported -> API:%dms)	
0x4101	Warning	General	Terminal-Overtemperature	Overtemperature. The internal temperature of the terminal exceeds the parameterized warning threshold.
0x4102	Warning	General	Discrepancy in the PDO-Configuration	The selected PDOs do not match the set operating mode. Sample: Drive operates in velocity mode, but the velocity PDO is but not mapped in the PDOs.
0x417F	Warning	General	Warning: 0x%X, 0x%X, 0x%X	
0x428D	Warning	General	Challenge is not Random	
0x4300	Warning	Encoder	Subincrements deactivated: %d, %d	Sub-increments deactivated (despite activated configuration)
0x4301	Warning	Encoder	Encoder-Warning	General encoder error
0x4302	Warning	Encoder	Maximum frequency of the input signal is nearly reached (channel %d)	
0x4303	Warning	Encoder	Limit counter value was reduced because of the PDO configuration (channel %d)	
0x4304	Warning	Encoder	Reset counter value was reduced because of the PDO configuration (channel %d)	
0x4400	Warning	Drive	Drive is not calibrated: %d, %d	Drive is not calibrated
0x4401	Warning	Drive	Starttype not supported: 0x%X, %d	Start type is not supported
0x4402	Warning	Drive	Command rejected: %d, %d	Command rejected
0x4405	Warning	Drive	Invalid modulo subtype: %d, %d	Modulo sub-type invalid
0x4410	Warning	Drive	Target overrun: %d, %d	Target position exceeded
0x4411	Warning	Drive	DC-Link undervoltage (Warning)	The DC link voltage of the terminal is lower than the parameterized minimum voltage. Activation of the output stage is prevented.
0x4412	Warning	Drive	DC-Link overvoltage (Warning)	The DC link voltage of the terminal is higher than the parameterized maximum voltage. Activation of the output stage is prevented.
0x4413	Warning	Drive	I2T-Model Amplifier overload (Warning)	<ul style="list-style-type: none"> The amplifier is being operated outside the specification. The I2T-model of the amplifier is incorrectly parameterized.
0x4414	Warning	Drive	I2T-Model Motor overload (Warning)	<ul style="list-style-type: none"> The motor is being operated outside the parameterized rated values.

Text ID	Type	Place	Text Message	Additional comment
				<ul style="list-style-type: none"> The I2T-model of the motor is incorrectly parameterized.
0x4415	Warning	Drive	Speed limitation active	The maximum speed is limited by the parameterized objects (e.g. velocity limitation, motor speed limitation). This warning is output if the set velocity is higher than one of the parameterized limits.
0x4416	Warning	Drive	Step lost detected at position: 0x%X%X	Step loss detected
0x4417	Warning	Drive	Motor overtemperature	The internal temperature of the motor exceeds the parameterized warning threshold
0x4418	Warning	Drive	Limit: Current	Limit: current is limited
0x4419	Warning	Drive	Limit: Amplifier I2T-model exceeds 100%%	The threshold values for the maximum current were exceeded.
0x441A	Warning	Drive	Limit: Motor I2T-model exceeds 100%%	Limit: Motor I2T-model exceeds 100%
0x441B	Warning	Drive	Limit: Velocity limitation	The threshold values for the maximum speed were exceeded.
0x441C	Warning	Drive	STO while the axis was enabled	An attempt was made to activate the axis, despite the fact that no voltage is present at the STO input.
0x4600	Warning	General IO	Wrong supply voltage range	Supply voltage not in the correct range
0x4610	Warning	General IO	Wrong output voltage range	Output voltage not in the correct range
0x4705	Warning		Processor usage at %d %%	Processor load at %d %%
0x470A	Warning		EtherCAT Frame missed (change Settings or DC Operation Mode or Sync0 Shift Time)	EtherCAT frame missed (change DC Operation Mode or Sync0 Shift Time under Settings)

Text ID	Type	Place	Text Message	Additional comment
0x8000	Error	System	%s: %s	
0x8001	Error	System	Error: 0x%X, 0x%X, 0x%X	General error; parameters depend on event. See device documentation for interpretation.
0x8002	Error	System	Communication aborted	Communication aborted
0x8003	Error	System	Configuration error: 0x%X, 0x%X, 0x%X	General; parameters depend on event. See device documentation for interpretation.
0x8004	Error	System	%s: Unsuccessful FwdOpen-Response received from %d.%d.%d.%d (%s) (Error: %u)	
0x8005	Error	System	%s: FwdClose-Request sent to %d.%d.%d.%d (%s)	
0x8006	Error	System	%s: Unsuccessful FwdClose-Response received from %d.%d.%d.%d (%s) (Error: %u)	
0x8007	Error	System	%s: Connection with %d.%d.%d.%d (%s) closed	
0x8100	Error	General	Status word set: 0x%X, %d	Error bit set in the status word
0x8101	Error	General	Operation mode incompatible to PDO interface: 0x%X, %d	Mode of operation incompatible with the PDO interface
0x8102	Error	General	Invalid combination of Inputs and Outputs PDOs	Invalid combination of input and output PDOs
0x8103	Error	General	No variable linkage	No variables linked
0x8104	Error	General	Terminal-Overtemperature	The internal temperature of the terminal exceeds the parameterized error threshold. Activation of the terminal is prevented
0x8105	Error	General	PD-Watchdog	Communication between the fieldbus and the output stage is secured by a Watchdog. The axis is stopped automatically if the fieldbus communication is interrupted. <ul style="list-style-type: none"> The EtherCAT connection was interrupted during operation. The Master was switched to Config mode during operation.
0x8135	Error	General	Cycle time has to be a multiple of 125 µs	The IO or NC cycle time divided by 125 µs does not produce a whole number.
0x8136	Error	General	Configuration error: invalid sampling rate	Configuration error: Invalid sampling rate
0x8137	Error	General	Electronic type plate: CRC error	Content of the external name plate memory invalid.
0x8140	Error	General	Sync Error	Real-time violation
0x8141	Error	General	Sync%X Interrupt lost	Sync%X Interrupt lost
0x8142	Error	General	Sync Interrupt asynchronous	Sync Interrupt asynchronous
0x8143	Error	General	Jitter too big	Jitter limit violation
0x817F	Error	General	Error: 0x%X, 0x%X, 0x%X	
0x8200	Error	Communication	Write access error: %d, %d	Error while writing
0x8201	Error	Communication	No communication to field-side (Auxiliary voltage missing)	<ul style="list-style-type: none"> There is no voltage applied to the power contacts. A firmware update has failed.
0x8281	Error	Communication	Ownership failed: %X	
0x8282	Error	Communication	To many Keys founded	
0x8283	Error	Communication	Key Creation failed: %X	
0x8284	Error	Communication	Key loading failed	
0x8285	Error	Communication	Reading Public Key failed: %X	
0x8286	Error	Communication	Reading Public EK failed: %X	
0x8287	Error	Communication	Reading PCR Value failed: %X	
0x8288	Error	Communication	Reading Certificate EK failed: %X	
0x8289	Error	Communication	Challenge could not be hashed: %X	
0x828A	Error	Communication	Tickstamp Process failed	
0x828B	Error	Communication	PCR Process failed: %X	
0x828C	Error	Communication	Quote Process failed: %X	
0x82FF	Error	Communication	Bootmode not activated	Boot mode not activated
0x8300	Error	Encoder	Set position error: 0x%X, %d	Error while setting the position

Text ID	Type	Place	Text Message	Additional comment
0x8301	Error	Encoder	Encoder increments not configured: 0x%X, %d	Encoder increments not configured
0x8302	Error	Encoder	Encoder error	The amplitude of the resolver is too small
0x8303	Error	Encoder	Encoder power missing (channel %d)	
0x8304	Error	Encoder	Encoder communication error, channel: %X	Encoder communication error
0x8305	Error	Encoder	EnDat2.2 is not supported, channel: %X	EnDat2.2 is not supported
0x8306	Error	Encoder	Delay time, tolerance limit exceeded, 0x%X, channel: %X	Runtime measurement, tolerance exceeded
0x8307	Error	Encoder	Delay time, maximum value exceeded, 0x%X, channel: %X	Runtime measurement, maximum value exceeded
0x8308	Error	Encoder	Unsupported ordering designation, 0x%X, channel: %X (only 02 and 22 is supported)	Wrong EnDat order ID
0x8309	Error	Encoder	Encoder CRC error, channel: %X	Encoder CRC error
0x830A	Error	Encoder	Temperature %X could not be read, channel: %X	Temperature cannot be read
0x830C	Error	Encoder	Encoder Single-Cycle-Data Error, channel: %X	CRC error detected. Check the transmission path and the CRC polynomial
0x830D	Error	Encoder	Encoder Watchdog Error, channel: %X	The sensor has not responded within a predefined time period
0x8310	Error	Encoder	Initialisation error	
0x8311	Error	Encoder	Maximum frequency of the input signal is exceeded (channel %d)	
0x8312	Error	Encoder	Encoder plausibility error (channel %d)	
0x8313	Error	Encoder	Configuration error (channel %d)	
0x8314	Error	Encoder	Synchronisation error	
0x8315	Error	Encoder	Error status input (channel %d)	
0x8400	Error	Drive	Incorrect drive configuration: 0x%X, %d	Drive incorrectly configured
0x8401	Error	Drive	Limiting of calibration velocity: %d, %d	Limitation of the calibration velocity
0x8402	Error	Drive	Emergency stop activated: 0x%X, %d	Emergency stop activated
0x8403	Error	Drive	ADC Error	Error during current measurement in the ADC
0x8404	Error	Drive	Overcurrent	Overcurrent in phase U, V or W
0x8405	Error	Drive	Invalid modulo position: %d	Modulo position invalid
0x8406	Error	Drive	DC-Link undervoltage (Error)	The DC link voltage of the terminal is lower than the parameterized minimum voltage. Activation of the output stage is prevented.
0x8407	Error	Drive	DC-Link overvoltage (Error)	The DC link voltage of the terminal is higher than the parameterized maximum voltage. Activation of the output stage is prevented.
0x8408	Error	Drive	I2T-Model Amplifier overload (Error)	<ul style="list-style-type: none"> The amplifier is being operated outside the specification. The I2T-model of the amplifier is incorrectly parameterized.
0x8409	Error	Drive	I2T-Model motor overload (Error)	<ul style="list-style-type: none"> The motor is being operated outside the parameterized rated values. The I2T-model of the motor is incorrectly parameterized.
0x840A	Error	Drive	Overall current threshold exceeded	Total current exceeded
0x8415	Error	Drive	Invalid modulo factor: %d	Modulo factor invalid
0x8416	Error	Drive	Motor overtemperature	The internal temperature of the motor exceeds the parameterized error threshold. The motor stops immediately. Activation of the output stage is prevented.
0x8417	Error	Drive	Maximum rotating field velocity exceeded	Rotary field speed exceeds the value specified for dual use (EU 1382/2014).
0x841C	Error	Drive	STO while the axis was enabled	An attempt was made to activate the axis, despite the fact that no voltage is present at the STO input.

Text ID	Type	Place	Text Message	Additional comment
0x8550	Error	Inputs	Zero crossing phase %X missing	Zero crossing phase %X missing
0x8551	Error	Inputs	Phase sequence Error	Wrong direction of rotation
0x8552	Error	Inputs	Overcurrent phase %X	Overcurrent phase %X
0x8553	Error	Inputs	Overcurrent neutral wire	Overcurrent neutral wire
0x8581	Error	Inputs	Wire broken Ch %D	Wire broken Ch %d
0x8600	Error	General IO	Wrong supply voltage range	Supply voltage not in the correct range
0x8601	Error	General IO	Supply voltage to low	Supply voltage too low
0x8602	Error	General IO	Supply voltage to high	Supply voltage too high
0x8603	Error	General IO	Over current of supply voltage	Overcurrent of supply voltage
0x8610	Error	General IO	Wrong output voltage range	Output voltage not in the correct range
0x8611	Error	General IO	Output voltage to low	Output voltage too low
0x8612	Error	General IO	Output voltage to high	Output voltage too high
0x8613	Error	General IO	Over current of output voltage	Overcurrent of output voltage
0x8700	Error		Channel/Interface not calibrated	Channel/interface not synchronized
0x8701	Error		Operating time was manipulated	Operating time was manipulated
0x8702	Error		Oversampling setting is not possible	Oversampling setting not possible
0x8703	Error		No slave controller found	No slave controller found
0x8704	Error		Slave controller is not in Bootstrap	Slave controller is not in bootstrap
0x8705	Error		Processor usage to high (>= 100%%)	Processor load too high (>= 100%%)
0x8706	Error		Channel in saturation	Channel in saturation
0x8707	Error		Channel overload	Channel overload
0x8708	Error		Overloadtime was manipulated	Overload time was manipulated
0x8709	Error		Saturationtime was manipulated	Saturation time was manipulated
0x870A	Error		Channel range error	Measuring range error for the channel
0x870B	Error		no ADC clock	No ADC clock available
0xFFFF	Information		Debug: 0x%X, 0x%X, 0x%X	Debug: 0x%X, 0x%X, 0x%X

8.5.2 Notes on Diag Messages associated with Motor Terminals

● „Ack. Message“ Button



The ‚Ack. Message‘ button has no effect on the Drive State Machine of the Motor terminals, pressing the button does not make an axis reset. The Drive State Machine has no influence on the error list, an axis reset also does not remove any entries from the error list, however, this can be done by pressing the ‚Ack. Message‘ button.

9 Advanced device information

9.1 Controller structure

You can display the controller structure in Drive Manager 2 by selecting the "Tune Drive" menu. Click on individual elements in the controller structure to display their internal structure.

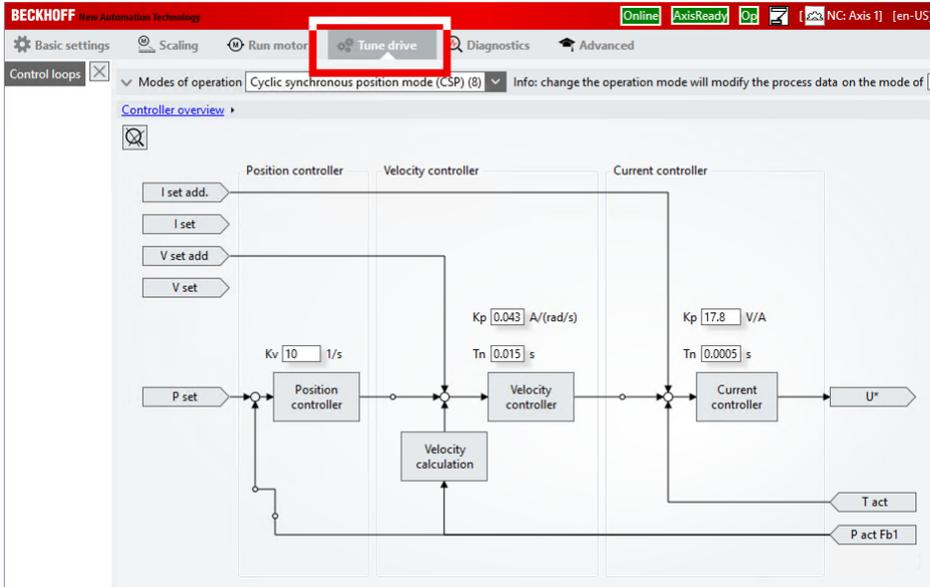

9.2 CoE parameters

9.2.1 Configuration data

i Automatic configuration

Some parameters are set automatically when the electronic identification plate is read in. The index of these parameters is marked with an asterisk (*).

You can activate the reading of the electronic identification plate in the parameters "Enable auto config":

- Channel 1: 8008:01
- Channel 2: 8108:01 (ELM72x2 only)

Index 8000 FB Settings Ch.1

Index (hex)	Name	Meaning	Data type	Flags	Default
8000:0	FB Settings Ch.1		UINT8	RO	0x17 (23 _{dec})
8000:02	Referenced	Can be set to TRUE by the user. Is automatically set to FALSE as soon as a motor with a deviating serial number is recognized or if the feedback is single-turn. Must be set to TRUE if a gear ratio or modulo factor is configured.	BOOLEAN	RW	0x00 (0 _{dec})
8000:0D	Offset position actual value source	permitted values: <ul style="list-style-type: none"> • 0: Offset disabled • 1: Encoder memory • 2: Drive memory 	BIT4	RW	0x00 (0 _{dec})
8000:11	Device type		UINT32	RW	0x00000605 (1541 _{dec})
8000:12	Singleturn bits ¹⁾	Number of single-turn bits. The sum of the single-turn bits and multi-turn bits must be 32.	UINT8	RW	0x14 (20 _{dec})
8000:13	Multiturn bits ¹⁾	Number of multi-turn bits. The sum of the single-turn bits and multi-turn bits must be 32.	UINT8	RW	0x0C (12 _{dec})
8000:14	Observer bandwidth	Bandwidth of the speed observer [Hz]	UINT16	RW	0x01F4 (500 _{dec})
8000:15	Observer feed-forward	Load ratio [%] between internal rotor inertia of the motor and the total inertia of the driven system. Load ratio = internal moment of inertia / (internal moment of inertia + mass moment of inertia of the load). Examples: 100 % = load-free 50 % = mass moments of inertia of input and output are equal	UINT8	RW	0x64 (100 _{dec})
8000:17	Position offset	The position offset is subtracted from the raw position of the encoder. It can only be written with the axis stopped. This object maps the value of the 'Drive Memory' (see 8000:0D); the 'Encoder Memory' cannot be influenced/read via this object.	UINT32	RW	0x00000000 (0 _{dec})

¹⁾ This is only the representation of the position in the PDO, the physical resolution of the feedback is unaffected.

Index 8001 FB Touch probe Settings Ch.1

Index (hex)	Name	Meaning	Data type	Flags	Default
8001:0	FB Touch probe Settings Ch.1		UINT8	RO	0x12 (18 _{dec})
8001:11	Touch probe 1 source	Permitted values: 1: Touch probe input 1	INT16	RW	0x0001 (1 _{dec})
8001:12	Touch probe 2 source	Permitted values: 2: Touch probe input 2	INT16	RW	0x0002 (2 _{dec})

Index 8008 FB OCT Settings Ch.1

Index (hex)	Name	Meaning	Data type	Flags	Default
8008:0	FB OCT Settings Ch.1		UINT8	RO	0x03 (3 _{dec})
8008:01	Enable auto config	Configuration takes place automatically after the reading of the electronic identification plate.	BOOLEAN	RW	0x00 (0 _{dec})
8008:02	Reconfig identical motor	When replacing identical motors ¹⁾ , reconfiguration takes place automatically after reading the electronic identification plate. 8008:01 "Enable auto config" must be TRUE.	BOOLEAN	RW	0x00 (0 _{dec})
8008:03	Reconfig non-identical motor	When replacing non-identical motors ¹⁾ , reconfiguration takes place automatically after reading the electronic identification plate. 8008:01 "Enable auto config" must be TRUE.	BOOLEAN	RW	0x00 (0 _{dec})

¹⁾ The terminal uses parameter 9009:04 "Order code" to check whether the motor is identical.

Index 8010 DRV Amplifier Settings Ch.1

Index (hex)	Name	Meaning	Data type	Flags	Default
8010:0	DRV Amplifier Settings Ch.1		UINT8	RO	0x70 (112 _{dec})
8010:01	Enable TxPDOToggle	Show TxPDO Toggle in the status word (bit 10).	BOOLEAN	RW	0x00 (0 _{dec})
8010:02	Enable input cycle counter	1: enabled The Input cycle counter is a two-bit counter that is incremented with each process data cycle up to a maximum value of 3, after which it starts again at 0. The low bit is represented in bit 10 and the high bit in bit 14 of the status word.	BOOLEAN	RW	0x00 (0 _{dec})
8010:12*	Current loop integral time	Integral component of current controller. Unit: 0.1 ms This value is affected by automatic scanning.	UINT16	RW	0x000A (10 _{dec})
8010:13*	Current loop proportional gain	Proportional component of current controller. Unit: 0.1 V/A This value is affected by automatic scanning.	UINT16	RW	0x000A (10 _{dec})
8010:14	Velocity loop integral time	Integral component of velocity controller. Unit: 0.1 ms	UINT32	RW	0x00000032 (50 _{dec})
8010:15	Velocity loop proportional gain	Proportional component of velocity controller. Unit: mA / (rad/s)	UINT32	RW	0x00000096 (150 _{dec})
8010:17	Position loop proportional gain	Proportional component position controller. Unit: (rad/s) / rad	UINT32	RW	0x0000000A (10 _{dec})
8010:29	Amplifier I2T warn level	I ² T model warning threshold. Unit: %	UINT8	RW	0x50 (80 _{dec})
8010:2A	Amplifier I2T error level	I ² T model error threshold. Unit: %	UINT8	RW	0x69 (105 _{dec})
8010:31	Velocity limitation	Velocity limitation. Unit: 1/min	UINT32	RW	0x000186A0 (100000 _{dec})
8010:33	Stand still window	Standstill window Unit: 1/min	UINT16	RW	0x0000 (0 _{dec})
8010:39	Select info data 1	Permitted values: <ul style="list-style-type: none"> • 2: DC link voltage (mV) • 4: PCB temperature (0.1 °C) • 7: I2T Motor • 8: I2T Amplifier • 10: Digital inputs • 15: Motor temperature (0,1°C) • 16: I2T Brake Chopper 	UINT8	RW	0x02 (2 _{dec})

8010:3A	Select info data 2	Permitted values: <ul style="list-style-type: none"> • 2: DC link voltage (mV) • 4: PCB temperature (0.1 °C) • 7: I2T Motor • 8: I2T Amplifier • 10: Digital inputs • 15: Motor temperature (0,1°C) • 16: I2T Brake Chopper 	UINT8	RW	0x04 (4 _{dec})
8010:49	Halt ramp deceleration	Halt ramp deceleration. Unit: 0.1 rad / s ²	UINT32	RW	0x0000F570 (62832 _{dec})
8010:50	Following error window	Following error monitor: following error window. Unit: the given value must be multiplied by the corresponding scaling factor 0xFFFFFFFF (-1 _{dec}) = following error monitor off. Any other value = following error monitor on.	UINT32	RW	0xFFFFFFFF (-1 _{dec})
8010:51	Following error time out	Following error monitor: timeout. Unit: ms If the following error is larger than the following error window for a time that exceeds the timeout, this leads to an error reaction.	UINT16	RW	0x0000 (0 _{dec})
8010:52	Fault reaction option code	Permitted values: <ul style="list-style-type: none"> • 0: Disable drive function, motor is free to rotate • 1: Slow down on slow down ramp (Deceleration see 8010:49) 	UINT16	RW	0x0000 (0 _{dec})
8010:54	Feature bits		UINT32	RW	0x00000000 (0 _{dec})
8010:57	Position loop velocity feed forward gain	Scaling factor for velocity pre-control from the position interpolator.	UINT8	RW	0x64 (100 _{dec})
8010:58	Select info data 3	Permitted values: <ul style="list-style-type: none"> • 2: DC link voltage (mV) • 4: PCB temperature (0.1 °C) • 7: I2T Motor • 8: I2T Amplifier • 10: Digital inputs • 15: Motor temperature (0,1°C) • 16: I2T Brake Chopper 	UINT8	RW	0x07 (7 _{dec})
8010:59	Error suppression mask		UINT32	RW	0x00000000 (0 _{dec})
8010:62	Position loop deadband window	Deadband window of the position controller. Unit: increments	UINT32	RW	0x00000000 (0 _{dec})
8010:66	Enable cogging torque compensation	Activate cogging compensation.	BOOLEAN	RW	0x01 (1 _{dec})
8010:6D	Torque feed forward gain	Internal torque pre-control: scaling factor	UINT32	RW	0x00000064 (100 _{dec})
8010:6E	Torque feed forward filter time	Internal torque pre-control: filter time. Unit: 0.1 ms	UINT32	RW	0x00000000 (0 _{dec})
8010:6F	Torque offset	Torque offset. The value is given in thousandths of the nominal current.	INT16	RW	0x0000 (0 _{dec})
8010:70	Torque limitation option code	Permitted values: <ul style="list-style-type: none"> • 0: VeloLimitHasNoEffect • 1: TorqueMightBeReducedToZero • 2: TorqueMightBeReducedToRampPosNeg • 3: TorqueMightBeReducedToRampPosMax-TorqueNeg • 4: TorqueMightBeReducedToMaxTorquePos-Neg 	INT8	RW	0x00 (0 _{dec})

Index 8011 DRV Motor Settings Ch.1

Index (hex)	Name	Meaning	Data type	Flags	Default
8011:0	DRV Motor Settings Ch.1		UINT8	RO	0x2D (45 _{dec})
8011:11*	Max current	Peak current. Unit: mA	UINT32	RW	0x00001770 (6000 _{dec})
8011:12*	Rated current	Nominal current. Unit: mA	UINT32	RW	0x000003E8 (1000 _{dec})
8011:13*	Motor pole pairs	Number of pole pairs.	UINT8	RW	0x01 (1 _{dec})
8011:15*	Commutation offset	Commutation offset between the electrical zero position and the mechanical single-turn zero position. Unit: °	INT16	RW	0xFFA6 (65446 _{dec})
8011:16*	Torque constant	Torque constant. Unit: mNm / A	UINT32	RW	0x00000001 (1 _{dec})
8011:18*	Rotor moment of inertia	Mass moment of inertia of the motor. Unit: g cm ²	UINT32	RW	0x000001F4 (500 _{dec})
8011:19*	Winding inductance	Winding inductance. Unit: 0.1 mH	UINT16	RW	0x0064 (100 _{dec})
8011:1B*	Motor speed limitation	Velocity limitation. Unit: 1/min	UINT32	RW	0x000186A0 (100000 _{dec})
8011:29	I2T warn level	I2T model warning threshold. Unit: %	UINT8	RW	0x50 (80 _{dec})
8011:2A	I2T error level	I2T model error threshold. Unit: %	UINT8	RW	0x69 (105 _{dec})
8011:2B*	Motor Temperature warn level	Overtemperature warning threshold. Unit: 0.1 °C	UINT16	RW	0x03E8 (1000 _{dec})
8011:2C	Motor Temperature error level	Overtemperature error threshold. Unit: 0.1 °C	UINT16	RW	0x05DC (1500 _{dec})
8011:2D*	Motor thermal time constant	Thermal time constant. Unit: 0.1 s	UINT16	RW	0x0028 (40 _{dec})

Index 8012 DRV Brake Settings Ch.1

Index (hex)	Name	Meaning	Data type	Flags	Default
8012:0	DRV Brake Settings Ch.1		UINT8	RO	0x14 (20 _{dec})
8012:01	Enable manual override	Enable for manual control of the holding brake.	BOOLEAN	RW	0x00 (0 _{dec})
8012:02	Manual brake state	Permitted values: • 0: Release = release brake • 1: Apply = apply brake	BIT1	RW	0x00 (0 _{dec})
8012:11*	Release delay	Time the holding brake requires for opening (releasing) after the current was applied.	UINT16	RW	0x0000 (0 _{dec})
8012:12*	Application delay	Time the holding brake requires for closing (holding) after the current was switched off.	UINT16	RW	0x0000 (0 _{dec})
8012:13	Emergency application timeout	Time that the amplifier waits for the velocity to reach the standstill limit after a stop request. If the waiting time is exceeded, the holding brake is triggered; regardless of the velocity. Note: This parameter must be set at least to the longest time the axis needs to come to a standstill after it has been switched torque-free. For vertical axes, this parameter should be set to a low value to prevent the axis or load from falling very far. Unit: ms	UINT16	RW	0x0000 (0 _{dec})
8012:14*	Brake moment of inertia	Mass moment of inertia of the brake. Unit: g cm ²	UINT16	RW	0x0000 (0 _{dec})

Index 8013 DRV Filter Settings Ch.1

Index (hex)	Name	Meaning	Data type	Flags	Default
8013:0	DRV Filter Settings Ch.1		UINT8	RO	0x19 (25 _{dec})
8013:10	Low pass frequency 1		REAL32	RW	0x00000000 (0 _{dec})
8013:11	Low pass damping 1		REAL32	RW	0x00000000 (0 _{dec})
8013:12	High pass frequency 1		REAL32	RW	0x00000000 (0 _{dec})
8013:13	High pass damping 1		REAL32	RW	0x00000000 (0 _{dec})
8013:14	Filter type 1	Permitted values: <ul style="list-style-type: none"> • 0: No_Filter • 1: Low_pass_filter_1_order • 2: Phase_correction_filter_1_order • 3: Low_pass_filter_2_order • 4: Phase_correction_filter_2_order • 5: Notch_filter 	INT16	RW	0x0000 (0 _{dec})
8013:15	Low pass frequency 2		REAL32	RW	0x00000000 (0 _{dec})
8013:16	Low pass damping 2		REAL32	RW	0x00000000 (0 _{dec})
8013:17	High pass frequency 2		REAL32	RW	0x00000000 (0 _{dec})
8013:18	High pass damping 2		REAL32	RW	0x00000000 (0 _{dec})
8013:19	Filter type 2	Permitted values: <ul style="list-style-type: none"> • 0: No_Filter • 1: Low_pass_filter_1_order • 2: Phase_correction_filter_1_order • 3: Low_pass_filter_2_order • 4: Phase_correction_filter_2_order • 5: Notch_filter 	INT16	RW	0x0000 (0 _{dec})

Index 8020 DMC Settings Ch.1

Index (hex)	Name	Meaning	Data type	Flags	Default
8020:0	DMC Settings Ch.1		UINT8	RO	0x17 (23 _{dec})
8020:07	Emergency deceleration	Deceleration for the emergency stop ramp. (In ms from motor nominal speed to standstill) Unit: 1 ms	UINT16	RW	0x0064 (100 _{dec})
8020:08	Calibration position	If homing is successful, the "Actual position" is set to this value.	INT64	RW	0
8020:09	Calibration velocity (towards plc cam)	Velocity when hitting the cam in 10000ths of the motor nominal speed.	INT16	RW	0x0064 (100 _{dec})
8020:0A	Calibration Velocity (off plc cam)	Velocity when driving off the cam in 10000ths of the motor nominal speed.	INT16	RW	0x000A (10 _{dec})
8020:0E	Modulo factor	Feedback increments for one mechanical revolution.	INT64	RW	0x100000000 (4294967296 _{dec})
8020:12	Block calibration torque limit	Torque limitation for approaching the end stop. In parts per thousand of the nominal motor current.	UINT16	RW	0x0064 (100 _{dec})
8020:13	Block calibration stop distance	After reaching the calibration position, the axis moves out of the end position by this distance.	INT64	RW	0x100000000 (4294967296 _{dec})
8020:14	Block calibration lag threshold	When this following error is exceeded, the axis is in the end position.	INT64	RW	0x100000000 (4294967296 _{dec})
8020:15	Target position window	Target position window: The In-Target bit is set when the axis is within this window for at least the time set under 0x8020:16.	INT64	RW	0x16C16C1 (23860929 _{dec})
8020:16	Target position monitor time	see 0x8020:15 Unit: ms	UINT16	RW	0x0014 (20 _{dec})
8020:17	Target position timeout	When the setpoint generator has reached its end position and the axis is not in the target window after this time has elapsed, the task is terminated and the in-target bit is not set. Unit: ms	UINT16	RW	0x1770 (6000 _{dec})

Index 8021 DMC Features Ch.1

Index (hex)	Name	Meaning	Data type	Flags	Default
8021:0	DMC Features Ch.1		UINT8	RO	0x1B (27 _{dec})
8021:13	Invert calibration cam search direction	Invert the direction of movement to search for the limit switch. Default: FALSE = search with positive direction of rotation.	BOOLEAN	RW	0x00 (0 _{dec})
8021:14	Invert sync impulse search direction	Invert the direction of rotation to exit the limit switch. Default: TRUE = exit in negative direction of rotation.	BOOLEAN	RW	0x01 (1 _{dec})
8021:19	Calibration cam source	Source for the reference switch. • 0: Input 1 • 1: Input 2	UINT8	RW	0x00 (0 _{dec})
8021:1A	Calibration cam active level	State of the reference switch in the actuated state. • 0: Hi • 1: Low	UINT8	RW	0x00 (0 _{dec})
8021:1B*	Latch source	Source for the latch unit. • 0: Input 1 • 1: Input 2	UINT8	RW	0x00 (0 _{dec})

Index 8100 FB Settings Ch.2 (ELM72x2 only)

Index (hex)	Name	Meaning	Data type	Flags	Default
8100:0	FB Settings Ch.2		UINT8	RO	0x17 (23 _{dec})
8100:02	Referenced	Can be set to TRUE by the user. Is automatically set to FALSE as soon as a motor with a deviating serial number is recognized or if the feedback is single-turn. Must be set to TRUE if a gear ratio or modulo factor is configured.	BOOLEAN	RW	0x00 (0 _{dec})
8100:0D	Offset position actual value source	permitted values: <ul style="list-style-type: none"> • 0: Offset disabled • 1: Encoder memory • 2: Drive memory 	BIT4	RW	0x00 (0 _{dec})
8100:11	Device type		UINT32	RW	0x00000605 (1541 _{dec})
8100:12	Singleturn bits ¹⁾	Number of single-turn bits. The sum of the single-turn bits and multi-turn bits must be 32.	UINT8	RW	0x14 (20 _{dec})
8100:13	Multiturn bits ¹⁾	Number of multi-turn bits. The sum of the single-turn bits and multi-turn bits must be 32.	UINT8	RW	0x0C (12 _{dec})
8100:14	Observer bandwidth	Bandwidth of the speed observer [Hz]	UINT16	RW	0x01F4 (500 _{dec})
8100:15	Observer feed-forward	Load ratio [%] between internal rotor inertia of the motor and the total inertia of the driven system. Load ratio = internal moment of inertia / (internal moment of inertia + mass moment of inertia of the load). Examples: 100 % = load-free 50 % = mass moments of inertia of input and output are equal	UINT8	RW	0x64 (100 _{dec})
8100:17	Position offset	The position offset is subtracted from the raw position of the encoder. It can only be written with the axis stopped. This object maps the value of the 'Drive Memory' (see 8100:0D); the 'Encoder Memory' cannot be influenced/read via this object.	UINT32	RW	0x00000000 (0 _{dec})

¹⁾ This is only the representation of the position in the PDO, the physical resolution of the feedback is unaffected.

Index 8101 FB Touch probe Settings Ch.2 (ELM72x2 only)

Index (hex)	Name	Meaning	Data type	Flags	Default
8101:0	FB Touch probe Settings Ch.2		UINT8	RO	0x12 (18 _{dec})
8101:11	Touch probe 1 source	Permitted values: 1: Touch probe input 1	INT16	RW	0x0001 (1 _{dec})
8101:12	Touch probe 2 source	Permitted values: 2: Touch probe input 2	INT16	RW	0x0002 (2 _{dec})

Index 8108 FB OCT Settings Ch.2 (ELM72x2 only)

Index (hex)	Name	Meaning	Data type	Flags	Default
8108:0	FB OCT Settings Ch.2		UINT8	RO	0x03 (3 _{dec})
8108:01	Enable auto config	Configuration takes place automatically after the reading of the electronic identification plate.	BOOLEAN	RW	0x00 (0 _{dec})
8108:02	Reconfig identical motor	When replacing identical motors ¹⁾ , reconfiguration takes place automatically after reading the electronic identification plate. 8108:01 "Enable auto config" must be TRUE.	BOOLEAN	RW	0x00 (0 _{dec})
8108:03	Reconfig non-identical motor	When replacing non-identical motors ¹⁾ , reconfiguration takes place automatically after reading the electronic identification plate. 8108:01 "Enable auto config" must be TRUE.	BOOLEAN	RW	0x00 (0 _{dec})

¹⁾ The terminal uses parameter 9109:04 "Order code" to check whether the motor is identical.

Index 8110 DRV Amplifier Settings Ch.2 (ELM72x2 only)

Index (hex)	Name	Meaning	Data type	Flags	Default
8110:0	DRV Amplifier Settings Ch.2		UINT8	RO	0x70 (112 _{dec})
8110:01	Enable TxPDO Toggle	Show TxPDO Toggle in the status word (bit 10).	BOOLEAN	RW	0x00 (0 _{dec})
8110:02	Enable input cycle counter	1: enabled The Input cycle counter is a two-bit counter that is incremented with each process data cycle up to a maximum value of 3, after which it starts again at 0. The low bit is represented in bit 10 and the high bit in bit 14 of the status word.	BOOLEAN	RW	0x00 (0 _{dec})
8110:12*	Current loop integral time	Integral component of current controller. Unit: 0.1 ms This value is affected by automatic scanning.	UINT16	RW	0x000A (10 _{dec})
8110:13*	Current loop proportional gain	Proportional component of current controller. Unit: 0.1 V/A This value is affected by automatic scanning.	UINT16	RW	0x000A (10 _{dec})
8110:14	Velocity loop integral time	Integral component of velocity controller. Unit: 0.1 ms	UINT32	RW	0x00000032 (50 _{dec})
8110:15	Velocity loop proportional gain	Proportional component of velocity controller. Unit: mA / (rad/s)	UINT32	RW	0x00000096 (150 _{dec})
8110:17	Position loop proportional gain	Proportional component position controller. Unit: (rad/s) / rad	UINT32	RW	0x0000000A (10 _{dec})
8110:29	Amplifier I2T warn level	I ² T model warning threshold. Unit: %	UINT8	RW	0x50 (80 _{dec})
8110:2A	Amplifier I2T error level	I ² T model error threshold. Unit: %	UINT8	RW	0x69 (105 _{dec})
8110:31	Velocity limitation	Velocity limitation. Unit: 1/min	UINT32	RW	0x000186A0 (100000 _{dec})
8110:33	Stand still window	Standstill window Unit: 1/min	UINT16	RW	0x0000 (0 _{dec})
8110:39	Select info data 1	Permitted values: <ul style="list-style-type: none"> • 2: DC link voltage (mV) • 4: PCB temperature (0.1 °C) • 7: I2T Motor • 8: I2T Amplifier • 10: Digital inputs • 15: Motor temperature (0,1°C) • 16: I2T Brake Chopper 	UINT8	RW	0x02 (2 _{dec})

8110:3A	Select info data 2	Permitted values: <ul style="list-style-type: none"> • 2: DC link voltage (mV) • 4: PCB temperature (0.1 °C) • 7: I2T Motor • 8: I2T Amplifier • 10: Digital inputs • 15: Motor temperature (0,1°C) • 16: I2T Brake Chopper 	UINT8	RW	0x04 (4 _{dec})
8110:49	Halt ramp deceleration	Halt ramp deceleration. Unit: 0.1 rad / s ²	UINT32	RW	0x0000F570 (62832 _{dec})
8110:50	Following error window	Following error monitor: following error window. Unit: the given value must be multiplied by the corresponding scaling factor 0xFFFFFFFF (-1 _{dec}) = following error monitor off. Any other value = following error monitor on.	UINT32	RW	0xFFFFFFFF (-1 _{dec})
8110:51	Following error time out	Following error monitor: timeout. Unit: ms If the following error is larger than the following error window for a time that exceeds the timeout, this leads to an error reaction.	UINT16	RW	0x0000 (0 _{dec})
8110:52	Fault reaction option code	Permitted values: <ul style="list-style-type: none"> • 0: Disable drive function, motor is free to rotate • 1: Slow down on slow down ramp (Deceleration see 8110:49) 	UINT16	RW	0x0000 (0 _{dec})
8110:54	Feature bits		UINT32	RW	0x00000000 (0 _{dec})
8110:57	Position loop velocity feed forward gain	Scaling factor for velocity pre-control from the position interpolator.	UINT8	RW	0x64 (100 _{dec})
8110:58	Select info data 3	Permitted values: <ul style="list-style-type: none"> • 2: DC link voltage (mV) • 4: PCB temperature (0.1 °C) • 7: I2T Motor • 8: I2T Amplifier • 10: Digital inputs • 15: Motor temperature (0,1°C) • 16: I2T Brake Chopper 	UINT8	RW	0x07 (7 _{dec})
8110:59	Error suppression mask		UINT32	RW	0x00000000 (0 _{dec})
8110:62	Position loop deadband window	Deadband window of the position controller. Unit: increments	UINT32	RW	0x00000000 (0 _{dec})
8110:66	Enable cogging torque compensation	Activate cogging compensation.	BOOLEAN	RW	0x01 (1 _{dec})
8110:6D	Torque feed forward gain	Internal torque pre-control: scaling factor	UINT32	RW	0x00000064 (100 _{dec})
8110:6E	Torque feed forward filter time	Internal torque pre-control: filter time. Unit: 0.1 ms	UINT32	RW	0x00000000 (0 _{dec})
8110:6F	Torque offset	Torque offset. The value is given in thousandths of the nominal current.	INT16	RW	0x0000 (0 _{dec})
8110:70	Torque limitation option code	Permitted values: <ul style="list-style-type: none"> • 0: VeloLimitHasNoEffect • 1: TorqueMightBeReducedToZero • 2: TorqueMightBeReducedToRampPosNeg • 3: TorqueMightBeReducedToRampPosMax-TorqueNeg • 4: TorqueMightBeReducedToMaxTorquePos-Neg 	INT8	RW	0x00 (0 _{dec})

Index 8111 DRV Motor Settings Ch.2 (ELM72x2 only)

Index (hex)	Name	Meaning	Data type	Flags	Default
8111:0	DRV Motor Settings Ch.2		UINT8	RO	0x2D (45 _{dec})
8111:11*	Max current	Peak current. Unit: mA	UINT32	RW	0x00001770 (6000 _{dec})
8111:12*	Rated current	Nominal current. Unit: mA	UINT32	RW	0x000003E8 (1000 _{dec})
8111:13*	Motor pole pairs	Number of pole pairs.	UINT8	RW	0x01 (1 _{dec})
8111:15*	Commutation offset	Commutation offset between the electrical zero position and the mechanical single-turn zero position. Unit: °	INT16	RW	0xFFA6 (65446 _{dec})
8111:16*	Torque constant	Torque constant. Unit: mNm / A	UINT32	RW	0x00000001 (1 _{dec})
8111:18*	Rotor moment of inertia	Mass moment of inertia of the motor. Unit: g cm ²	UINT32	RW	0x000001F4 (500 _{dec})
8111:19*	Winding inductance	Winding inductance. Unit: 0.1 mH	UINT16	RW	0x0064 (100 _{dec})
8111:1B*	Motor speed limitation	Velocity limitation. Unit: 1/min	UINT32	RW	0x000186A0 (100000 _{dec})
8111:29	I2T warn level	I2T model warning threshold. Unit: %	UINT8	RW	0x50 (80 _{dec})
8111:2A	I2T error level	I2T model error threshold. Unit: %	UINT8	RW	0x69 (105 _{dec})
8111:2B*	Motor Temperature warn level	Overtemperature warning threshold. Unit: 0.1 °C	UINT16	RW	0x03E8 (1000 _{dec})
8111:2C*	Motor Temperature error level	Overtemperature error threshold. Unit: 0.1 °C	UINT16	RW	0x05DC (1500 _{dec})
8111:2D*	Motor thermal time constant	Thermal time constant. Unit: 0.1 s	UINT16	RW	0x0028 (40 _{dec})

Index 8112 DRV Brake Settings Ch.2 (ELM72x2 only)

Index (hex)	Name	Meaning	Data type	Flags	Default
8112:0	DRV Brake Settings Ch.2		UINT8	RO	0x14 (20 _{dec})
8112:01	Enable manual override	Enable for manual control of the holding brake.	BOOLEAN	RW	0x00 (0 _{dec})
8112:02	Manual brake state	Permitted values: • 0: Release = release brake • 1: Apply = apply brake	BIT1	RW	0x00 (0 _{dec})
8112:11*	Release delay	Time the holding brake requires for opening (releasing) after the current was applied.	UINT16	RW	0x0000 (0 _{dec})
8112:12*	Application delay	Time the holding brake requires for closing (holding) after the current was switched off.	UINT16	RW	0x0000 (0 _{dec})
8112:13	Emergency application timeout	Time that the amplifier waits for the velocity to reach the standstill limit after a stop request. If the waiting time is exceeded, the holding brake is triggered; regardless of the velocity. Note: This parameter must be set at least to the longest time the axis needs to come to a standstill after it has been switched torque-free. For vertical axes, this parameter should be set to a low value to prevent the axis or load from falling very far. Unit: ms	UINT16	RW	0x0000 (0 _{dec})
8112:14*	Brake moment of inertia	Mass moment of inertia of the brake. Unit: g cm ²	UINT16	RW	0x0000 (0 _{dec})

Index 8113 DRV Filter Settings Ch.2 (ELM72x2 only)

Index (hex)	Name	Meaning	Data type	Flags	Default
8113:0	DRV Filter Settings Ch.2		UINT8	RO	0x19 (25 _{dec})
8113:10	Low pass frequency 1		REAL32	RW	0x00000000 (0 _{dec})
8113:11	Low pass damping 1		REAL32	RW	0x00000000 (0 _{dec})
8113:12	High pass frequency 1		REAL32	RW	0x00000000 (0 _{dec})
8113:13	High pass damping 1		REAL32	RW	0x00000000 (0 _{dec})
8113:14	Filter type 1	Permitted values: <ul style="list-style-type: none"> • 0: No_Filter • 1: Low_pass_filter_1_order • 2: Phase_correction_filter_1_order • 3: Low_pass_filter_2_order • 4: Phase_correction_filter_2_order • 5: Notch_filter 	INT16	RW	0x0000 (0 _{dec})
8113:15	Low pass frequency 2		REAL32	RW	0x00000000 (0 _{dec})
8113:16	Low pass damping 2		REAL32	RW	0x00000000 (0 _{dec})
8113:17	High pass frequency 2		REAL32	RW	0x00000000 (0 _{dec})
8113:18	High pass damping 2		REAL32	RW	0x00000000 (0 _{dec})
8113:19	Filter type 2	Permitted values: <ul style="list-style-type: none"> • 0: No_Filter • 1: Low_pass_filter_1_order • 2: Phase_correction_filter_1_order • 3: Low_pass_filter_2_order • 4: Phase_correction_filter_2_order • 5: Notch_filter 	INT16	RW	0x0000 (0 _{dec})

Index 8120 DMC Settings Ch.2 (ELM72x2 only)

Index (hex)	Name	Meaning	Data type	Flags	Default
8120:0	DMC Settings Ch.2		UINT8	RO	0x17 (23 _{dec})
8120:07	Emergency deceleration	Deceleration for the emergency stop ramp. (In ms from motor nominal speed to standstill) Unit: 1 ms	UINT16	RW	0x0064 (100 _{dec})
8120:08	Calibration position	If homing is successful, the "Actual position" is set to this value.	INT64	RW	0
8120:09	Calibration velocity (towards plc cam)	Velocity when hitting the cam in 10000ths of the motor nominal speed.	INT16	RW	0x0064 (100 _{dec})
8120:0A	Calibration Velocity (off plc cam)	Velocity when driving off the cam in 10000ths of the motor nominal speed.	INT16	RW	0x000A (10 _{dec})
8120:0E	Modulo factor	Feedback increments for one mechanical revolution.	INT64	RW	0x100000000 (4294967296 _{dec})
8120:12	Block calibration torque limit	Torque limitation for approaching the end stop. In parts per thousand of the nominal motor current.	UINT16	RW	0x0064 (100 _{dec})
8120:13	Block calibration stop distance	After reaching the calibration position, the axis moves out of the end position by this distance.	INT64	RW	0x100000000 (4294967296 _{dec})
8120:14	Block calibration lag threshold	When this following error is exceeded, the axis is in the end position.	INT64	RW	0x100000000 (4294967296 _{dec})
8120:15	Target position window	Target position window: The In-Target bit is set when the axis is within this window for at least the time set under 0x8120:16.	INT64	RW	0x16C16C1 (23860929 _{dec})
8120:16	Target position monitor time	see 0x8120:15 Unit: ms	UINT16	RW	0x0014 (20 _{dec})
8120:17	Target position timeout	When the setpoint generator has reached its end position and the axis is not in the target window after this time has elapsed, the task is terminated and the in-target bit is not set. Unit: ms	UINT16	RW	0x1770 (6000 _{dec})

Index 8121 DMC Features Ch.2 (ELM72x2 only)

Index (hex)	Name	Meaning	Data type	Flags	Default
8121:0	DMC Features Ch.2		UINT8	RO	0x1B (27 _{dec})
8121:13	Invert calibration cam search direction	Invert the direction of movement to search for the limit switch. Default: FALSE = search with positive direction of rotation.	BOOLEAN	RW	0x00 (0 _{dec})
8121:14	Invert sync impulse search direction	Invert the direction of rotation to exit the limit switch. Default: TRUE = exit in negative direction of rotation.	BOOLEAN	RW	0x01 (1 _{dec})
8121:19	Calibration cam source	Source for the reference switch. • 0: Input 1 • 1: Input 2	UINT8	RW	0x00 (0 _{dec})
8121:1A	Calibration cam active level	State of the reference switch in the actuated state. • 0: Hi • 1: Low	UINT8	RW	0x00 (0 _{dec})
8121:1B*	Latch source	Source for the latch unit. • 0: Input 1 • 1: Input 2	UINT8	RW	0x00 (0 _{dec})

Index F800 DRV Amplifier Settings

Index (hex)	Name	Meaning	Data type	Flags	Default
800F:0	DRV Amplifier Settings		UINT8	RO	0x17 (23 _{dec})
800F:10	Nominal DC link voltage	Nominal DC link voltage. Unit: mV	UINT32	RW	0x0000BB80 (48000 _{dec})
800F:11	Min DC link voltage	Minimum DC link voltage. Unit: mV	UINT32	RW	0x00001A90 (6800 _{dec})
800F:12	Max DC link voltage	Maximum DC link voltage. Unit: mV	UINT32	RW	0x0000EA60 (60000 _{dec})
800F:15	Amplifier Temperature warn level	Amplifier temperature warning threshold. Unit: 0.1 °C	UINT16	RW	0x0320 (800 _{dec})
800F:16	Amplifier Temperature error level	Amplifier temperature error threshold. Unit: 0.1 °C	UINT16	RW	0x03E8 (1000 _{dec})
800F:17	Feature bits		UINT32	RW	0x00000000 (0 _{dec})

Index F801 DRV Brake Chopper Settings

Index (hex)	Name	Meaning	Data type	Flags	Default
F801:0	DRV Brake Chopper Settings		UINT8	RO	0x19 (25 _{dec})
F801:11	External brake resistor value	Resistance value of the external braking resistor Unit: 0.1 Ω	UINT16	RW	0x001E (30 _{dec})
F801:12	External brake resistor continuous power	Nominal output of the external braking resistor. Unit: W	UINT16	RW	0x0064 (100 _{dec})
F801:13	Brake resistor power warning threshold	If this value is exceeded, an overload warning is issued for the braking resistor. The value is given as a percentage of the nominal output of the braking resistor (F801:12).	UINT16	RW	0x005A (90 _{dec})
F801:16	Ext brake resistor overload factor at 1% duty cycle	Overload factor of the resistor at a duty cycle of 1%	UINT8	RW	0x26 (38 _{dec})
F801:18	Brake chopper threshold overvoltage	DC link voltage above which the brake chopper switches on the resistor. Unit: mV	UINT32	RW	0x0000CB20 (52000 _{dec})
F801:19	Brake chopper hysteresis voltage	Hysteresis of the brake chopper. The resistor is switched off when the DC link voltage has fallen below 'Brake chopper threshold overvoltage' - 'Brake chopper hysteresis voltage'. Unit: mV	UINT32	RW	0x000003E8 (1000 _{dec})

Index F810 FAN Settings

Index (hex)	Name	Meaning	Data type	Flags	Default
F810:0	FAN Settings		UINT8	RO	0x11 (17 _{dec})
F810:11	Fan behaviour	permitted values: <ul style="list-style-type: none"> • 1: Speed level 1 (low) • 2: Speed level 2 • 3: Speed level 3 • 4: Speed level 4 • 5: Speed level 5 • 6: Speed level 6 • 7: Speed level 7 • 8: Speed level 8 • 9: Speed level 9 (high) • 10: Controlled by terminal temperature 	UINT8	RW	0x0A (10 _{dec})

9.2.2 Configuration data vendor-specific

Index 801F DRV Vendor data Ch.1

Index (hex)	Name	Meaning	Data type	Flags	Default
801F:0	DRV Vendor data Ch.1		UINT8	RO	0x18 (24 _{dec})
801F:11	Amplifier peak current	Peak current of the amplifier (RMS value). Unit: mA	UINT32	RW	¹⁾
801F:12	Amplifier rated current	Nominal current of the amplifier (RMS value). Unit: mA	UINT32	RW	²⁾
801F:14	Amplifier overcurrent threshold	Threshold value for short circuit detection, maximum phase current (peak value). Unit: mA	UINT32	RW	³⁾
801F:15	Max rotary field frequency	Maximum rotary field frequency. Unit: Hz	UINT16	RW	0x0257 (599 _{dec})
801F:16	Amplifier peak current with fan	Amplifier peak current with fan (RMS value). Unit: mA	UINT32	RW	⁴⁾
801F:17	Amplifier rated current with fan	Amplifier nominal current with fan (RMS value). Unit: mA	UINT32	RW	⁵⁾
801F:18	Vendor feature bits		UINT32	RW	0x00000000 (0 _{dec})

¹⁾ The default value of "Amplifier peak current" varies depending on the product:

- ELM7211-0010: 0x00002328 (9000_{dec})
- ELM7212-0010: 0x00002328 (9000_{dec})
- ELM7221-0010: 0x00003E80 (16000_{dec})
- ELM7222-0010: 0x00003E80 (16000_{dec})
- ELM7231-0010: 0x00007530 (30000_{dec})

²⁾ The default value of "Amplifier rated current" varies depending on the product:

- ELM7211-0010: 0x00001194 (4500_{dec})
- ELM7212-0010: 0x00001194 (4500_{dec})
- ELM7221-0010: 0x00001F40 (8000_{dec})
- ELM7222-0010: 0x00001F40 (8000_{dec})
- ELM7231-0010: 0x00003E80 (16000_{dec})

³⁾ The default value of "Amplifier overcurrent threshold" varies depending on the product:

- ELM7211-0010: 0x00006D60 (28000_{dec})
- ELM7212-0010: 0x00006D60 (28000_{dec})
- ELM7221-0010: 0x00006D60 (28000_{dec})
- ELM7222-0010: 0x00006D60 (28000_{dec})
- ELM7231-0010: 0x0000C350 (50000_{dec})

⁴⁾ The default value of "Amplifier peak current with fan" varies depending on the product:

- ELM7211-0010: 0x00002328 (9000_{dec})
- ELM7212-0010: 0x00002328 (9000_{dec})
- ELM7221-0010: 0x00003E80 (16000_{dec})
- ELM7222-0010: 0x00003E80 (16000_{dec})
- ELM7231-0010: 0x00007530 (30000_{dec})

⁵⁾ The default value of "Amplifier rated current with fan" varies depending on the product:

- ELM7211-0010: 0x00001194 (4500_{dec})
- ELM7212-0010: 0x00001194 (4500_{dec})
- ELM7221-0010: 0x00001F40 (8000_{dec})
- ELM7222-0010: 0x00001F40 (8000_{dec})
- ELM7231-0010: 0x00003E80 (16000_{dec})

Index 811F DRV Vendor data Ch.2 (ELM72x2 only)

Index (hex)	Name	Meaning	Data type	Flags	Default
811F:0	DRV Vendor data Ch.2		UINT8	RO	0x18 (24 _{dec})
811F:11	Amplifier peak current	Peak current of the amplifier (RMS value). Unit: mA	UINT32	RW	¹⁾
811F:12	Amplifier rated current	Nominal current of the amplifier (RMS value). Unit: mA	UINT32	RW	²⁾
811F:14	Amplifier overcurrent threshold	Threshold value for short circuit detection, maximum phase current (peak value). Unit: mA	UINT32	RW	³⁾
811F:15	Max rotary field frequency	Maximum rotary field frequency. Unit: Hz	UINT16	RW	0x0257 (599 _{dec})
811F:16	Amplifier peak current with fan	Amplifier peak current with fan (RMS value). Unit: mA	UINT32	RW	⁴⁾
811F:17	Amplifier rated current with fan	Amplifier nominal current with fan (RMS value). Unit: mA	UINT32	RW	⁵⁾
811F:18	Vendor feature bits		UINT32	RW	0x00000000 (0 _{dec})

¹⁾ The default value of "Amplifier peak current" varies depending on the product:

- ELM7211-0010: 0x00002328 (9000_{dec})
- ELM7212-0010: 0x00002328 (9000_{dec})
- ELM7221-0010: 0x00003E80 (16000_{dec})
- ELM7222-0010: 0x00003E80 (16000_{dec})
- ELM7231-0010: 0x00007530 (30000_{dec})

²⁾ The default value of "Amplifier rated current" varies depending on the product:

- ELM7211-0010: 0x00001194 (4500_{dec})
- ELM7212-0010: 0x00001194 (4500_{dec})
- ELM7221-0010: 0x00001F40 (8000_{dec})
- ELM7222-0010: 0x00001F40 (8000_{dec})
- ELM7231-0010: 0x00003E80 (16000_{dec})

³⁾ The default value of "Amplifier overcurrent threshold" varies depending on the product:

- ELM7211-0010: 0x00006D60 (28000_{dec})
- ELM7212-0010: 0x00006D60 (28000_{dec})
- ELM7221-0010: 0x00006D60 (28000_{dec})
- ELM7222-0010: 0x00006D60 (28000_{dec})
- ELM7231-0010: 0x0000C350 (50000_{dec})

⁴⁾ The default value of "Amplifier peak current with fan" varies depending on the product:

- ELM7211-0010: 0x00002328 (9000_{dec})
- ELM7212-0010: 0x00002328 (9000_{dec})
- ELM7221-0010: 0x00003E80 (16000_{dec})
- ELM7222-0010: 0x00003E80 (16000_{dec})
- ELM7231-0010: 0x00007530 (30000_{dec})

⁵⁾ The default value of "Amplifier rated current with fan" varies depending on the product:

- ELM7211-0010: 0x00001194 (4500_{dec})
- ELM7212-0010: 0x00001194 (4500_{dec})
- ELM7221-0010: 0x00001F40 (8000_{dec})
- ELM7222-0010: 0x00001F40 (8000_{dec})
- ELM7231-0010: 0x00003E80 (16000_{dec})

Index FB13 DRV Key code

Index (hex)	Name	Meaning	Data type	Flags	Default
FB13:0	DRV Key code		UINT8	RO	0x01 (1 _{dec})
FB13:01	Code		OCTET-STRING[32]	RW	{0}

9.2.3 Command object

Index FB00 Command

Index (hex)	Name	Meaning	Data type	Flags	Default
FB00:0	Command		UINT8	RO	0x03 (3 _{dec})
FB00:01	Request		OCTET-STRING[2]	RW	{0}
FB00:02	Status		UINT8	RO	0x00 (0 _{dec})
FB00:03	Response		OCTET-STRING[6]	RO	{0}

9.2.4 Input data

Index 6000 FB Inputs Ch.1

Index (hex)	Name	Meaning	Data type	Flags	Default
6000:0	FB Inputs Ch.1		UINT8	RO	0x11 (17 _{dec})
6000:0E	TxPDO State	TRUE: the position data is invalid. FALSE: the position data is valid.	BOOLEAN	RO	0x00 (0 _{dec})
6000:0F	Input cycle counter	Incremented with each process data cycle, switches to 0 after reaching the maximum value of 3.	BIT2	RO	0x00 (0 _{dec})
6000:11	Position	Position	UINT32	RO	0x00000000 (0 _{dec})

Index 6001 FB Touch probe inputs Ch.1

Index (hex)	Name	Meaning	Data type	Flags	Default
6001:0	FB Touch probe inputs Ch.1		UINT8	RO	0x18 (24 _{dec})
6001:01	TP1 Enable	Touch probe 1 switched on	BOOLEAN	RO	0x00 (0 _{dec})
6001:02	TP1 Pos value stored	Positive value of Touch probe 1 stored	BOOLEAN	RO	0x00 (0 _{dec})
6001:03	TP1 Neg value stored	Negative value of Touch probe 1 stored	BOOLEAN	RO	0x00 (0 _{dec})
6001:08	TP1 Input	Digital inputs Touch probe 1. The input must be addressed with a single conductor + 24 V signal.	BOOLEAN	RO	0x00 (0 _{dec})
6001:09	TP2 Enable	Touch probe 2 switched on	BOOLEAN	RO	0x00 (0 _{dec})
6001:0A	TP2 Pos value stored	Positive value of Touch probe 2 stored	BOOLEAN	RO	0x00 (0 _{dec})
6001:0B	TP2 Neg value stored	Negative value of Touch probe 2 stored	BOOLEAN	RO	0x00 (0 _{dec})
6001:10	TP2 Input	Digital input Touch probe 2. The input must be addressed with a single conductor + 24 V signal.	BOOLEAN	RO	0x00 (0 _{dec})
6001:11	TP1 Pos position	Positive value of Touch probe 1. Unit: the given value must be multiplied by the corresponding scaling factor.	UINT32	RO	0x00000000 (0 _{dec})
6001:12	TP1 Neg position	Negative value of Touch probe 1. Unit: the given value must be multiplied by the corresponding scaling factor.	UINT32	RO	0x00000000 (0 _{dec})
6001:13	TP2 Pos position	Positive value of Touch probe 2. Unit: the given value must be multiplied by the corresponding scaling factor.	UINT32	RO	0x00000000 (0 _{dec})
6001:14	TP2 Neg position	Negative value of Touch probe 2. Unit: the given value must be multiplied by the corresponding scaling factor.	UINT32	RO	0x00000000 (0 _{dec})
6001:15	TP1 Pos timestamp	DC timestamp at which the last positive edge was detected on Touch probe 1.	UINT32	RO	0x00000000 (0 _{dec})
6001:16	TP1 Neg timestamp	DC timestamp at which the last negative edge was detected on Touch probe 1.	UINT32	RO	0x00000000 (0 _{dec})
6001:17	TP2 Pos timestamp	DC timestamp at which the last positive edge was detected on Touch probe 2.	UINT32	RO	0x00000000 (0 _{dec})
6001:18	TP2 Neg timestamp	DC timestamp at which the last negative edge was detected on Touch probe 2.	UINT32	RO	0x00000000 (0 _{dec})

Index 6010 DRV Inputs Ch.1

Index (hex)	Name	Meaning	Data type	Flags	Default
6010:0	DRV Inputs Ch.1		UINT8	RO	0x15 (21 _{dec})
6010:01	Statusword	Bit 0: Ready to switch on Bit 1: Switched on Bit 2: Operation enabled Bit 3: Fault Bit 4: reserved Bit 5: reserved Bit 6: Switch on disabled Bit 7: Warning Bit 8 + 9: reserved Bit 10: TxPDOToggle (Switch on via 0x8010:01 [▶ 69]) Bit 11: Internal limit active Bit 12: Drive follows the command value Bit 13: Input cycle counter Bit 14 - 15: reserved	UINT16	RO	0x0000 (0 _{dec})
6010:03	Modes of operation display	Modes of operation display. Possible values: <ul style="list-style-type: none"> • 8: Cyclic synchronous position mode (CSP) • 9: Cyclic synchronous velocity mode (CSV) • 10: Cyclic synchronous torque mode (CST) • 11: Cyclic synchronous torque mode with commutation angle (CSTCA) • 131: Drive Motion Control (DMC) 	UINT8	RO	0x00 (0 _{dec})
6010:06	Following error actual value	Following error. Unit: the given value must be multiplied by the corresponding scaling factor.	INT32	RO	0x00000000 (0 _{dec})
6010:07	Velocity actual value	Display of the current velocity value. Unit: see 0x9010:14 [▶ 100].	INT32	RO	0x00000000 (0 _{dec})
6010:08	Torque actual value	Display of the current torque value The value is given in 1000ths of the "Rated current" (0x8011:12 [▶ 71]). Calculation formula: $M = ((\text{Torque actual value} / 1000) \times \text{rated current}) \times \text{torque constant}$ (0x8011:16 [▶ 71])	INT16	RO	0x0000 (0 _{dec})
6010:12	Info data 1	Synchronous information. Selection via 0x8010:39 [▶ 69].	UINT16	RO	0x0000 (0 _{dec})
6010:13	Info data 2	Synchronous information. Selection via 0x8010:3A [▶ 69].	UINT16	RO	0x0000 (0 _{dec})
6010:14	Info data 3	Synchronous information. Selection via 0x8010:58 [▶ 69].	UINT16	RO	0x0000 (0 _{dec})
6010:15	Torque limitation status	Bit 0: Torque demand value is equal to ramp input Bit 1: High velocity limit active Bit 2: Low velocity limit active Bit 3 - 7: reserved	UINT8	RO	0x00 (0 _{dec})

Index 6020 DMC Inputs Ch.1

Index (hex)	Name	Meaning	Data type	Flags	Default
6020:0	DMC Inputs Ch.1		UINT8	RO	0x3C (60 _{dec})
6020:02	DMC__FeedbackStatus__Latched extern valid	An edge was detected on the external input and latched.	BOOLEAN	RO	0x00 (0 _{dec})
6020:03	DMC__FeedbackStatus__Set counter done	The setting of the feedback position was successful. This bit remains present until "Set counter" is released again	BOOLEAN	RO	0x00 (0 _{dec})
6020:0D	DMC__FeedbackStatus__Status of extern latch	Status of the external latch input.	BOOLEAN	RO	0x00 (0 _{dec})
6020:11	DMC__DriveStatus__Ready to enable	The drive hardware is ready for activation.	BOOLEAN	RO	0x00 (0 _{dec})
6020:12	DMC__DriveStatus__Ready	The drive hardware is activated.	BOOLEAN	RO	0x00 (0 _{dec})
6020:13	DMC__DriveStatus__Warning	A warning is pending in the drive.	BOOLEAN	RO	0x00 (0 _{dec})
6020:14	DMC__DriveStatus__Error	An error is pending in the drive. The "Ready to enable" bit and the "Ready" bit are set to FALSE.	BOOLEAN	RO	0x00 (0 _{dec})
6020:15	DMC__DriveStatus__Moving positive	The axis moves in positive direction.	BOOLEAN	RO	0x00 (0 _{dec})
6020:16	DMC__DriveStatus__Moving negative	The axis moves in negative direction.	BOOLEAN	RO	0x00 (0 _{dec})
6020:1C	DMC__DriveStatus__Digital input 1	Status of the first digital input.	BOOLEAN	RO	0x00 (0 _{dec})
6020:1D	DMC__DriveStatus__Digital input 2	Status of the second digital input.	BOOLEAN	RO	0x00 (0 _{dec})
6020:21	DMC__PositioningStatus__Busy	The positioning task is running.	BOOLEAN	RO	0x00 (0 _{dec})
6020:22	DMC__PositioningStatus__In-Target	The axis is at the target position.	BOOLEAN	RO	0x00 (0 _{dec})
6020:23	DMC__PositioningStatus__Warning	Warning.	BOOLEAN	RO	0x00 (0 _{dec})
6020:24	DMC__PositioningStatus__Error	Error.	BOOLEAN	RO	0x00 (0 _{dec})
6020:25	DMC__PositioningStatus__Calibrated	The axis is calibrated.	BOOLEAN	RO	0x00 (0 _{dec})
6020:26	DMC__PositioningStatus__Accelerate	The axis accelerates.	BOOLEAN	RO	0x00 (0 _{dec})
6020:27	DMC__PositioningStatus__Decelerate	The axis is decelerating.	BOOLEAN	RO	0x00 (0 _{dec})
6020:28	DMC__PositioningStatus__Ready to execute	The path control is ready to accept a command. This bit is FALSE ... <ul style="list-style-type: none"> • ... if the drive has a fault • ... if the drive is not activated • ... as long as the "PositioningControl__Execute" is pending. 	BOOLEAN	RO	0x00 (0 _{dec})
6020:31	DMC__Set position	Current target position specified by the ramp generator in feedback increments.	INT64	RO	
6020:32	DMC__Set velocity	Current velocity specified by the ramp generator in 10000ths of the nominal motor speed	INT16	RO	0x0000 (0 _{dec})
6020:33	DMC__Actual drive time	The time since the start of the travel command in ms. Stops when the target position is reached.	UINT32	RO	0x00000000 (0 _{dec})
6020:34	DMC__Actual position lag	Following error.	INT64	RO	
6020:35	DMC__Actual velocity	Current velocity in 10000ths of the nominal motor speed.	INT16	RO	0x0000 (0 _{dec})
6020:36	DMC__Actual position	Current position from the feedback (incl. possible offsets due to homing, ...).	INT64	RO	
6020:37	DMC__Error id	Error Id (identical to Diag History).	UINT32	RO	0x00000000 (0 _{dec})

6020:38	DMC__Input cycle counter	Incremented with each process data cycle.	UINT8	RO	0x00 (0 _{dec})
6020:39	DMC__Channel id		UINT8	RO	0x00 (0 _{dec})
6020:3A	DMC__Latch value	Feedback position at latch time.	INT64	RO	
6020:3B	DMC__Cyclic info data 1	Synchronous info data	INT16	RO	0x0000 (0 _{dec})
6020:3C	DMC__Cyclic info data 2	Synchronous info data	INT16	RO	0x0000 (0 _{dec})

Index 6100 FB Inputs Ch.2

Index (hex)	Name	Meaning	Data type	Flags	Default
6100:0	FB Inputs Ch.2		UINT8	RO	0x11 (17 _{dec})
6100:0E	TxPDO State	TRUE: the position data is invalid. FALSE: the position data is valid.	BOOLEAN	RO	0x00 (0 _{dec})
6100:0F	Input cycle counter	Incremented with each process data cycle, switches to 0 after reaching the maximum value of 3.	BIT2	RO	0x00 (0 _{dec})
6100:11	Position	Position	UINT32	RO	0x00000000 (0 _{dec})

Index 6101 FB Touch probe inputs Ch.2

Index (hex)	Name	Meaning	Data type	Flags	Default
6101:0	FB Touch probe inputs Ch.2		UINT8	RO	0x18 (24 _{dec})
6101:01	TP1 Enable	Touch probe 1 switched on	BOOLEAN	RO	0x00 (0 _{dec})
6101:02	TP1 Pos value stored	Positive value of Touch probe 1 stored	BOOLEAN	RO	0x00 (0 _{dec})
6101:03	TP1 Neg value stored	Negative value of Touch probe 1 stored	BOOLEAN	RO	0x00 (0 _{dec})
6101:08	TP1 Input	Digital inputs Touch probe 1. The input must be addressed with a single conductor + 24 V signal.	BOOLEAN	RO	0x00 (0 _{dec})
6101:09	TP2 Enable	Touch probe 2 switched on	BOOLEAN	RO	0x00 (0 _{dec})
6101:0A	TP2 Pos value stored	Positive value of Touch probe 2 stored	BOOLEAN	RO	0x00 (0 _{dec})
6101:0B	TP2 Neg value stored	Negative value of Touch probe 2 stored	BOOLEAN	RO	0x00 (0 _{dec})
6101:10	TP2 Input	Digital input Touch probe 2. The input must be addressed with a single conductor + 24 V signal.	BOOLEAN	RO	0x00 (0 _{dec})
6101:11	TP1 Pos position	Positive value of Touch probe 1. Unit: the given value must be multiplied by the corresponding scaling factor.	UINT32	RO	0x00000000 (0 _{dec})
6101:12	TP1 Neg position	Negative value of Touch probe 1. Unit: the given value must be multiplied by the corresponding scaling factor.	UINT32	RO	0x00000000 (0 _{dec})
6101:13	TP2 Pos position	Positive value of Touch probe 2. Unit: the given value must be multiplied by the corresponding scaling factor.	UINT32	RO	0x00000000 (0 _{dec})
6101:14	TP2 Neg position	Negative value of Touch probe 2. Unit: the given value must be multiplied by the corresponding scaling factor.	UINT32	RO	0x00000000 (0 _{dec})
6101:15	TP1 Pos timestamp	DC timestamp at which the last positive edge was detected on Touch probe 1.	UINT32	RO	0x00000000 (0 _{dec})
6101:16	TP1 Neg timestamp	DC timestamp at which the last negative edge was detected on Touch probe 1.	UINT32	RO	0x00000000 (0 _{dec})
6101:17	TP2 Pos timestamp	DC timestamp at which the last positive edge was detected on Touch probe 2.	UINT32	RO	0x00000000 (0 _{dec})
6101:18	TP2 Neg timestamp	DC timestamp at which the last negative edge was detected on Touch probe 2.	UINT32	RO	0x00000000 (0 _{dec})

Index 6110 DRV Inputs Ch.2

Index (hex)	Name	Meaning	Data type	Flags	Default
6110:0	DRV Inputs Ch.2		UINT8	RO	0x15 (21 _{dec})
6110:01	Statusword	Bit 0: Ready to switch on Bit 1: Switched on Bit 2: Operation enabled Bit 3: Fault Bit 4: reserved Bit 5: reserved Bit 6: Switch on disabled Bit 7: Warning Bit 8 + 9: reserved Bit 10: TxPDOToggle (Switch on via 0x8110:01 [▶ 75]) Bit 11: Internal limit active Bit 12: Drive follows the command value Bit 13: Input cycle counter Bit 14 - 15: reserved	UINT16	RO	0x0000 (0 _{dec})
6110:03	Modes of operation display	Modes of operation display. Possible values: <ul style="list-style-type: none"> • 8: Cyclic synchronous position mode (CSP) • 9: Cyclic synchronous velocity mode (CSV) • 10: Cyclic synchronous torque mode (CST) • 11: Cyclic synchronous torque mode with commutation angle (CSTCA) • 131: Drive Motion Control (DMC) 	UINT8	RO	0x00 (0 _{dec})
6110:06	Following error actual value	Following error. Unit: the given value must be multiplied by the corresponding scaling factor.	INT32	RO	0x00000000 (0 _{dec})
6110:07	Velocity actual value	Display of the current velocity value. Unit: see 0x9110:14 [▶ 103].	INT32	RO	0x00000000 (0 _{dec})
6110:08	Torque actual value	Display of the current torque value The value is given in 1000ths of the "Rated current" (0x8111:12 [▶ 77]). Calculation formula: $M = ((\text{Torque actual value} / 1000) \times \text{rated current}) \times \text{torque constant} (0x8111:16 [▶ 77])$	INT16	RO	0x0000 (0 _{dec})
6110:12	Info data 1	Synchronous information. Selection via 0x8110:39 [▶ 75].	UINT16	RO	0x0000 (0 _{dec})
6110:13	Info data 2	Synchronous information. Selection via 0x8110:3A [▶ 75].	UINT16	RO	0x0000 (0 _{dec})
6110:14	Info data 3	Synchronous information. Selection via 0x8110:58 [▶ 75].	UINT16	RO	0x0000 (0 _{dec})
6110:15	Torque limitation status	Bit 0: Torque demand value is equal to ramp input Bit 1: High velocity limit active Bit 2: Low velocity limit active Bit 3 - 7: reserved	UINT8	RO	0x00 (0 _{dec})

Index 6120 DMC Inputs Ch.2

Index (hex)	Name	Meaning	Data type	Flags	Default
6120:0	DMC Inputs Ch.2		UINT8	RO	0x3C (60 _{dec})
6120:02	DMC__FeedbackStatus__Latched extern valid	An edge was detected on the external input and latched.	BOOLEAN	RO	0x00 (0 _{dec})
6120:03	DMC__FeedbackStatus__Set counter done	The setting of the feedback position was successful. This bit remains present until "Set counter" is released again	BOOLEAN	RO	0x00 (0 _{dec})
6120:0D	DMC__FeedbackStatus__Status of extern latch	Status of the external latch input.	BOOLEAN	RO	0x00 (0 _{dec})
6120:11	DMC__DriveStatus__Ready to enable	The drive hardware is ready for activation.	BOOLEAN	RO	0x00 (0 _{dec})
6120:12	DMC__DriveStatus__Ready	The drive hardware is activated.	BOOLEAN	RO	0x00 (0 _{dec})
6120:13	DMC__DriveStatus__Warning	A warning is pending in the drive.	BOOLEAN	RO	0x00 (0 _{dec})
6120:14	DMC__DriveStatus__Error	An error is pending in the drive. The "Ready to enable" bit and the "Ready" bit are set to FALSE.	BOOLEAN	RO	0x00 (0 _{dec})
6120:15	DMC__DriveStatus__Moving positive	The axis moves in positive direction.	BOOLEAN	RO	0x00 (0 _{dec})
6120:16	DMC__DriveStatus__Moving negative	The axis moves in negative direction.	BOOLEAN	RO	0x00 (0 _{dec})
6120:1C	DMC__DriveStatus__Digital input 1	Status of the first digital input.	BOOLEAN	RO	0x00 (0 _{dec})
6120:1D	DMC__DriveStatus__Digital input 2	Status of the second digital input.	BOOLEAN	RO	0x00 (0 _{dec})
6120:21	DMC__PositioningStatus__Busy	The positioning task is running.	BOOLEAN	RO	0x00 (0 _{dec})
6120:22	DMC__PositioningStatus__In-Target	The axis is at the target position.	BOOLEAN	RO	0x00 (0 _{dec})
6120:23	DMC__PositioningStatus__Warning	Warning.	BOOLEAN	RO	0x00 (0 _{dec})
6120:24	DMC__PositioningStatus__Error	Error.	BOOLEAN	RO	0x00 (0 _{dec})
6120:25	DMC__PositioningStatus__Calibrated	The axis is calibrated.	BOOLEAN	RO	0x00 (0 _{dec})
6120:26	DMC__PositioningStatus__Accelerate	The axis accelerates.	BOOLEAN	RO	0x00 (0 _{dec})
6120:27	DMC__PositioningStatus__Decelerate	The axis is decelerating.	BOOLEAN	RO	0x00 (0 _{dec})
6120:28	DMC__PositioningStatus__Ready to execute	The path control is ready to accept a command. This bit is FALSE ... <ul style="list-style-type: none"> ... if the drive has a fault ... if the drive is not activated ... as long as the "PositioningControl__Execute" is pending. 	BOOLEAN	RO	0x00 (0 _{dec})
6120:31	DMC__Set position	Current target position specified by the ramp generator in feedback increments.	INT64	RO	
6120:32	DMC__Set velocity	Current velocity specified by the ramp generator in 10000ths of the nominal motor speed	INT16	RO	0x0000 (0 _{dec})
6120:33	DMC__Actual drive time	The time since the start of the travel command in ms. Stops when the target position is reached.	UINT32	RO	0x00000000 (0 _{dec})
6120:34	DMC__Actual position lag	Following error.	INT64	RO	
6120:35	DMC__Actual velocity	Current velocity in 10000ths of the nominal motor speed.	INT16	RO	0x0000 (0 _{dec})
6120:36	DMC__Actual position	Current position from the feedback (incl. possible offsets due to homing, ...).	INT64	RO	
6120:37	DMC__Error id	Error Id (identical to Diag History).	UINT32	RO	0x00000000 (0 _{dec})

6120:38	DMC__Input cycle counter	Incremented with each process data cycle.	UINT8	RO	0x00 (0 _{dec})
6120:39	DMC__Channel id		UINT8	RO	0x00 (0 _{dec})
6120:3A	DMC__Latch value	Feedback position at latch time.	INT64	RO	
6120:3B	DMC__Cyclic info data 1	Synchronous info data	INT16	RO	0x0000 (0 _{dec})
6120:3C	DMC__Cyclic info data 2	Synchronous info data	INT16	RO	0x0000 (0 _{dec})

Index F600 DRV Brake Chopper Inputs

Index (hex)	Name	Meaning	Data type	Flags	Default
F600:0	DRV Brake Chopper Inputs		UINT8	RO	0x12 (18 _{dec})
F600:03	Brake chopper I2T warning	I2T model at least "Brake resistor power warning threshold" utilized	BOOLEAN	RO	0x00 (0 _{dec})
F600:06	Brake chopper on	Braking resistor was switched on at least once in the last process data cycle	BOOLEAN	RO	0x00 (0 _{dec})
F600:11	Brake chopper dutycycle	Proportion of the time of the last process data cycle in which the braking resistor was active (without further filters). Unit: percent	UINT8	RO	0x00 (0 _{dec})
F600:12	Brake chopper I2T utilisation	Utilization of the I2T model of the brake chopper. Unit: percent	UINT8	RO	0x00 (0 _{dec})

9.2.5 Output data

Index 7001 FB Touch probe outputs Ch.1

Index (hex)	Name	Meaning	Data type	Flags	Default
7001:0	FB Touch probe outputs Ch.1		UINT8	RO	0x0E (14 _{dec})
7001:01	TP1 Enable	Switch on Touch probe 1	BOOLEAN	RO	0x00 (0 _{dec})
7001:02	TP1 Continuous	Possible values: <ul style="list-style-type: none"> • 0: triggered only on the first event. • 1: triggered on every event. 	BOOLEAN	RO	0x00 (0 _{dec})
7001:03	TP1 Trigger mode	Input 1 is triggered (not changeable).	BIT2	RO	0x00 (0 _{dec})
7001:05	TP1 Enable pos edge	Trigger on positive edge	BOOLEAN	RO	0x00 (0 _{dec})
7001:06	TP1 Enable neg edge	Trigger on negative edge	BOOLEAN	RO	0x00 (0 _{dec})
7001:09	TP2 Enable	Switch on Touch probe 2	BOOLEAN	RO	0x00 (0 _{dec})
7001:0A	TP2 Continuous	Possible values: <ul style="list-style-type: none"> • 0: triggered only on the first event. • 1: triggered on every event. 	BOOLEAN	RO	0x00 (0 _{dec})
7001:0B	TP2 Trigger mode	Input 2 is triggered (not changeable).	BIT2	RO	0x00 (0 _{dec})
7001:0D	TP2 Enable pos edge	Trigger on positive edge	BOOLEAN	RO	0x00 (0 _{dec})
7001:0E	TP2 Enable neg edge	Trigger on negative edge	BOOLEAN	RO	0x00 (0 _{dec})

Index 7010 DRV Outputs Ch.1

Index (hex)	Name	Meaning	Data type	Flags	Default
7010:0	DRV Outputs Ch.1		UINT8	RO	0x13 (19 _{dec})
7010:01	Controlword	Bit 0: Switch on Bit 1: Enable voltage Bit 2: reserved Bit 3: Enable operation Bit 4 - 6: reserved Bit 7: Fault reset Bit 8 - 15: reserved	UINT16	RO	0x0000 (0 _{dec})
7010:03	Modes of operation	permitted values: <ul style="list-style-type: none"> • 8: Cyclic synchronous position mode (CSP) • 9: Cyclic synchronous velocity mode (CSV) • 10: Cyclic synchronous torque mode (CST) • 11: Cyclic synchronous torque mode with commutation angle (CSTCA) • 131: Drive Motion Control (DMC) 	UINT8	RW	0x08 (8 _{dec})
7010:05	Target position	Configured target position. Unit: the value must be multiplied by the corresponding scaling factor.	UINT32	RO	0x00000000 (0 _{dec})
7010:06	Target velocity	Configured target velocity The velocity scaling can be taken from the index 0x9010:14 [► 100] ("Velocity encoder resolution").	INT32	RO	0x00000000 (0 _{dec})
7010:09	Target torque	Configured target torque. The value is specified in 1000ths of 0x8011:12 [► 71] "rated current". Calculation formula: M = ((Torque actual value / 1000) x rated current)) x torque constant (0x8011:16 [► 71])	INT16	RO	0x0000 (0 _{dec})
7010:0A	Torque offset	Offset of the torque value The value is specified in 1000ths of the parameter 0x8011:12 [► 71] "rated current" Calculation formula: M = ((Torque actual value / 1000) x rated current)) x torque constant (0x8011:16 [► 71])	INT16	RO	0x0000 (0 _{dec})
7010:0B	Torque limitation	Limit value of the torque for torque monitoring (Bipolar Limit) The value is given in 1000ths of the parameter 0x8011:12 [► 71] "rated current". Calculation formula: M = ((Torque actual value / 1000) x rated current)) x torque constant (0x8011:16 [► 71])	UINT16	RW	0x7FFF (32767 _{dec})
7010:0E	Commutation angle	Commutation angle for the CSTCA mode. Unit: 2 ¹⁶ / 360°	UINT16	RO	0x0000 (0 _{dec})
7010:0F	Velocity offset	external speed pre-control.	INT32	RO	0x00000000 (0 _{dec})
7010:10	Positive torque limit value	Torque limitation in positive direction of rotation. Scaling/unit: see 7010:0B	UINT16	RW	0x7FFF (32767 _{dec})
7010:11	Negative torque limit value	Torque limitation in negative direction of rotation. Scaling/unit: see 7010:0B	UINT16	RW	0x7FFF (32767 _{dec})
7010:12	Low velocity limit value	Lower velocity limit, if in CST mode the 'Torque limitation option code' parameter [8010:70] has been set to a value unequal to VeloLimitHasNoEffect (0).	INT32	RW	0x00000000 (0 _{dec})
7010:13	High velocity limit value	Upper velocity limit, if in CST mode the 'Torque limitation option code' parameter [8010:70] has been set to a value unequal to VeloLimitHasNoEffect (0).	INT32	RW	0x00000000 (0 _{dec})

Index 7020 DMC Outputs Ch.1

Index (hex)	Name	Meaning	Data type	Flags	Default
7020:0	DMC Outputs Ch.1		UINT8	RO	0x36 (54 _{dec})
7020:02	DMC__FeedbackControl__Enable latch extern on positive edge	Latches to the positive edge of the external input	BOOLEAN	RO	0x00 (0 _{dec})
7020:03	DMC__FeedbackControl__Set counter	With a rising edge "Actual position" is set to the value of "Set counter value".	BOOLEAN	RO	0x00 (0 _{dec})
7020:04	DMC__FeedbackControl__Enable latch extern on negative edge	Latches to the negative edge of the external input	BOOLEAN	RO	0x00 (0 _{dec})
7020:11	DMC__DriveControl__Enable	Activate drive	BOOLEAN	RO	0x00 (0 _{dec})
7020:12	DMC__DriveControl__Reset	Perform a reset of the drive hardware	BOOLEAN	RO	0x00 (0 _{dec})
7020:21	DMC__PositioningControl__Execute	Start motion command with rising edge The task runs as long as this bit is set or until the command is completed. If the level drops during travel, the axis is brought to a standstill with the deceleration specified for the task.	BOOLEAN	RO	0x00 (0 _{dec})
7020:22	DMC__PositioningControl__Emergency stop	In the event of a rising edge, decelerate to a standstill with the emergency stop ramp	BOOLEAN	RO	0x00 (0 _{dec})
7020:31	DMC__Set counter value	s. 0x7020:03	INT64	RO	
7020:32	DMC__Target position	Position specification in feedback increments	INT64	RO	
7020:33	DMC__Target velocity	Maximum velocity during the motion command in 10000ths of the motor nominal speed	INT16	RO	0x0000 (0 _{dec})
7020:34	DMC__Start type	Type of positioning task: 0x0001: Absolute 0x0002: Relative 0x0003: Endless + 0x0004: Endless - 0x0105: Modulo short 0x0205: Modulo + 0x0305: Modulo - 0x6000: Cali PLC cam 0x6200: Cali Block 0x6E00: Cali set 0x6F00: Cali clear	UINT16	RO	0x0000 (0 _{dec})
7020:35	DMC__Target acceleration	Acceleration: time in ms from standstill to reaching the motor nominal speed	UINT16	RO	0x0000 (0 _{dec})
7020:36	DMC__Target deceleration	Deceleration: time in ms for the deceleration from the motor nominal speed to standstill	UINT16	RO	0x0000 (0 _{dec})

Index 7101 FB Touch probe outputs Ch.2

Index (hex)	Name	Meaning	Data type	Flags	Default
7101:0	FB Touch probe outputs Ch.2		UINT8	RO	0x0E (14 _{dec})
7101:01	TP1 Enable	Switch on Touch probe 1	BOOLEAN	RO	0x00 (0 _{dec})
7101:02	TP1 Continuous	Possible values: <ul style="list-style-type: none"> • 0: triggered only on the first event. • 1: triggered on every event. 	BOOLEAN	RO	0x00 (0 _{dec})
7101:03	TP1 Trigger mode	Input 1 is triggered (not changeable).	BIT2	RO	0x00 (0 _{dec})
7101:05	TP1 Enable pos edge	Trigger on positive edge	BOOLEAN	RO	0x00 (0 _{dec})
7101:06	TP1 Enable neg edge	Trigger on negative edge	BOOLEAN	RO	0x00 (0 _{dec})
7101:09	TP2 Enable	Switch on Touch probe 2	BOOLEAN	RO	0x00 (0 _{dec})
7101:0A	TP2 Continuous	Possible values: <ul style="list-style-type: none"> • 0: triggered only on the first event. • 1: triggered on every event. 	BOOLEAN	RO	0x00 (0 _{dec})
7101:0B	TP2 Trigger mode	Input 2 is triggered (not changeable).	BIT2	RO	0x00 (0 _{dec})
7101:0D	TP2 Enable pos edge	Trigger on positive edge	BOOLEAN	RO	0x00 (0 _{dec})
7101:0E	TP2 Enable neg edge	Trigger on negative edge	BOOLEAN	RO	0x00 (0 _{dec})

Index 7110 DRV Outputs Ch.2

Index (hex)	Name	Meaning	Data type	Flags	Default
7110:0	DRV Outputs Ch.2		UINT8	RO	0x13 (19 _{dec})
7110:01	Controlword	Bit 0: Switch on Bit 1: Enable voltage Bit 2: reserved Bit 3: Enable operation Bit 4 - 6: reserved Bit 7: Fault reset Bit 8 - 15: reserved	UINT16	RO	0x0000 (0 _{dec})
7110:03	Modes of operation	permitted values: <ul style="list-style-type: none"> • 8: Cyclic synchronous position mode (CSP) • 9: Cyclic synchronous velocity mode (CSV) • 10: Cyclic synchronous torque mode (CST) • 11: Cyclic synchronous torque mode with commutation angle (CSTCA) • 131: Drive Motion Control (DMC) 	UINT8	RW	0x08 (8 _{dec})
7110:05	Target position	Configured target position. Unit: the value must be multiplied by the corresponding scaling factor.	UINT32	RO	0x00000000 (0 _{dec})
7110:06	Target velocity	Configured target velocity. The velocity scaling can be found in index 0x9110:14 [▸ 103] ("Velocity encoder resolution").	INT32	RO	0x00000000 (0 _{dec})
7110:09	Target torque	Configured target torque. The value is specified in 1000ths of 0x8111:12 [▸ 77] "rated current". Calculation formula: $M = ((\text{Torque actual value} / 1000) \times \text{rated current}) \times \text{torque constant (0x8111:16 [▸ 77])}$	INT16	RO	0x0000 (0 _{dec})
7110:0A	Torque offset	Torque value offset. The value is specified in 1000ths of 0x8111:12 [▸ 77] "rated current" Calculation formula: $M = ((\text{Torque actual value} / 1000) \times \text{rated current}) \times \text{torque constant (0x8111:16 [▸ 77])}$	INT16	RO	0x0000 (0 _{dec})
7110:0B	Torque limitation	Limit value of the torque for torque monitoring (Bipolar Limit). The value is given in 1000ths of the parameter 0x8111:12 [▸ 77] "rated current". Calculation formula: $M = ((\text{Torque actual value} / 1000) \times \text{rated current}) \times \text{torque constant (0x8111:16 [▸ 77])}$	UINT16	RW	0x7FFF (32767 _{dec})
7110:0E	Commutation angle	Commutation angle for the CSTCA mode. Unit: $2^{16} / 360^\circ$	UINT16	RO	0x0000 (0 _{dec})
7110:0F	Velocity offset	external speed pre-control.	INT32	RO	0x00000000 (0 _{dec})
7110:10	Positive torque limit value	Torque limitation in positive direction of rotation. Scaling/unit: see 7010:0B	UINT16	RW	0x7FFF (32767 _{dec})
7110:11	Negative torque limit value	Torque limitation in negative direction of rotation. Scaling/unit: see 7010:0B	UINT16	RW	0x7FFF (32767 _{dec})
7110:12	Low velocity limit value	Lower velocity limit, if in CST mode the 'Torque limitation option code' parameter [8010:70] has been set to a value unequal to VeloLimitHasNoEffect (0).	INT32	RW	0x00000000 (0 _{dec})
7110:13	High velocity limit value	Upper velocity limit, if in CST mode the 'Torque limitation option code' parameter [8010:70] has been set to a value unequal to VeloLimitHasNoEffect (0).	INT32	RW	0x00000000 (0 _{dec})

Index 7120 DMC Outputs Ch.2

Index (hex)	Name	Meaning	Data type	Flags	Default
7120:0	DMC Outputs Ch.2		UINT8	RO	0x36 (54 _{dec})
7120:02	DMC__FeedbackControl__Enable latch extern on positive edge	Latches to the positive edge of the external input	BOOLEAN	RO	0x00 (0 _{dec})
7120:03	DMC__FeedbackControl__Set counter	With a rising edge "Actual position" is set to the value of "Set counter value".	BOOLEAN	RO	0x00 (0 _{dec})
7120:04	DMC__FeedbackControl__Enable latch extern on negative edge	Latches to the negative edge of the external input	BOOLEAN	RO	0x00 (0 _{dec})
7120:11	DMC__DriveControl__Enable	Activate drive	BOOLEAN	RO	0x00 (0 _{dec})
7120:12	DMC__DriveControl__Reset	Perform a reset of the drive hardware	BOOLEAN	RO	0x00 (0 _{dec})
7120:21	DMC__PositioningControl__Execute	Start motion command with rising edge The task runs as long as this bit is set or until the command is completed. If the level drops during travel, the axis is brought to a standstill with the deceleration specified for the task.	BOOLEAN	RO	0x00 (0 _{dec})
7120:22	DMC__PositioningControl__Emergency stop	In the event of a rising edge, decelerate to a standstill with the emergency stop ramp	BOOLEAN	RO	0x00 (0 _{dec})
7120:31	DMC__Set counter value	s. 0x7020:03	INT64	RO	
7120:32	DMC__Target position	Position specification in feedback increments	INT64	RO	
7120:33	DMC__Target velocity	Maximum velocity during the motion command in 10000ths of the motor nominal speed	INT16	RO	0x0000 (0 _{dec})
7120:34	DMC__Start type	Type of positioning task: 0x0001: Absolute 0x0002: Relative 0x0003: Endless + 0x0004: Endless - 0x0105: Modulo short 0x0205: Modulo + 0x0305: Modulo - 0x6000: Cali PLC cam 0x6200: Cali Block 0x6E00: Cali set 0x6F00: Cali clear	UINT16	RO	0x0000 (0 _{dec})
7120:35	DMC__Target acceleration	Acceleration: time in ms from standstill to reaching the motor nominal speed	UINT16	RO	0x0000 (0 _{dec})
7120:36	DMC__Target deceleration	Deceleration: time in ms for the deceleration from the motor nominal speed to standstill	UINT16	RO	0x0000 (0 _{dec})

9.2.6 Information data, diagnostic data

Index 10F3 Diagnosis History

Index (hex)	Name	Meaning	Data type	Flags	Default
10F3:0	Diagnosis History		UINT8	RO	0x37 (55 _{dec})
10F3:01	Maximum Messages		UINT8	RO	0x00 (0 _{dec})
10F3:02	Newest Message		UINT8	RO	0x00 (0 _{dec})
10F3:03	Newest Acknowledged Message		UINT8	RW	0x00 (0 _{dec})
10F3:04	New Messages Available		BOOLEAN	RO	0x00 (0 _{dec})
10F3:05	Flags		UINT16	RW	0x0000 (0 _{dec})
10F3:06	Diagnosis Message 001		OCTET-STRING[64]	RO	{0}
10F3:07	Diagnosis Message 002		OCTET-STRING[64]	RO	{0}
10F3:08	Diagnosis Message 003		OCTET-STRING[64]	RO	{0}
...
10F3:35	Diagnosis Message 048		OCTET-STRING[64]	RO	{0}
10F3:36	Diagnosis Message 049		OCTET-STRING[64]	RO	{0}
10F3:37	Diagnosis Message 050		OCTET-STRING[64]	RO	{0}

Index 9008 FB OCT Info data Ch.1

Index (hex)	Name	Meaning	Data type	Flags	Default
9008:0	FB OCT Info data Ch.1		UINT8	RO	0x20 (32 _{dec})
9008:11	Encoder Type	Feedback type 2: rotary encoder, unipolar counting	UINT16	RO	0x0000 (0 _{dec})
9008:12	Resolution	Resolution of the feedback. Unit: steps per revolution	UINT32	RO	0x00000000 (0 _{dec})
9008:13	Range	Working area of the feedback. On leaving this range there is an overflow of the position. Unit: revolutions	UINT32	RO	0x00000000 (0 _{dec})
9008:14	Type Code Name	Name of the feedback.	STRING	RO	
9008:15	Serial No	Serial number of the feedback	STRING	RO	
9008:16	Firmware Revision No	Revision of the firmware.	STRING	RO	
9008:17	Firmware Date	Date of the firmware.	STRING	RO	
9008:18	EEPROM Size	EEPROM size.	UINT16	RO	0x0000 (0 _{dec})
9008:19	Temperature	Temperature. Unit: 0.1 °C	INT16	RO	0x0000 (0 _{dec})
9008:1A	LED Current	Current of the feedback LED. Unit: 0.1 mA	UINT16	RO	0x0000 (0 _{dec})
9008:1B*	Supply voltage	Supply voltage of the feedback. Unit: mV	UINT32	RO	0x00000000 (0 _{dec})
9008:1C	Life- time	Operating hours counter. Unit: minutes	UINT32	RO	0x00000000 (0 _{dec})
9008:1D	Received Signal Strength Indicator	Received signal strength at the terminal. Unit: %	UINT16	RO	0x0000 (0 _{dec})
9008:1E	Slave Received Signal Strength Indicator	Received signal strength at the encoder. Unit: %	UINT16	RO	0x0000 (0 _{dec})
9008:1F	Line delay	Running time of the signal in the cable. Unit: ns	UINT16	RO	0x0000 (0 _{dec})
9008:20	Encoder position offset	Position offset stored in the motor feedback.	UINT32	RO	0x00000000 (0 _{dec})

Index 9009 FB OCT Nameplate Ch.1

The parameters described in this index are always read from the electronic identification plate of the connected motor.

With these parameters some configuration parameters can be set automatically. See chapter [Configuration data \[▶ 67\]](#).

Index (hex)	Name	Meaning	Data type	Flags	Default
9009:0	FB OCT Nameplate Ch.1		UINT8	RO	0x24 (36 _{dec})
9009:01	Motor vendor	Motor vendor	STRING	RO	
9009:02	Electric motor type	Motor type	STRING	RO	
9009:03	Serial No	Serial number	STRING	RO	
9009:04	Order code	Order number	STRING	RO	
9009:05	Motor construction	Type of motor	STRING	RO	
9009:06	Pole pairs	Number of pole pairs	UINT32	RO	0x00000000 (0 _{dec})
9009:07	Standstill current (rms)	Effective holding current Unit: mA	UINT32	RO	0x00000000 (0 _{dec})
9009:08	Rated current (rms)	Effective nominal current Unit: mA	UINT32	RO	0x00000000 (0 _{dec})
9009:09	Peak current (rms)	Effective peak current Unit: mA	UINT32	RO	0x00000000 (0 _{dec})
9009:0A	Nominal voltage (rms)	Effective nominal voltage Unit: mV	UINT32	RO	0x00000000 (0 _{dec})
9009:0B	Max voltage (rms)	Maximum voltage Unit: mV	UINT32	RO	0x00000000 (0 _{dec})
9009:0C	Max winding du/dt	Maximum permissible voltage rise on the winding Unit: kV / s	UINT32	RO	0x00000000 (0 _{dec})
9009:0D	Max torque	Maximum torque Unit: mNm	UINT16	RO	0x0000 (0 _{dec})
9009:0E	Torque constant	Torque constant Unit: mNm / A	UINT16	RO	0x0000 (0 _{dec})
9009:0F	EMF (rms)	Countervoltage Unit: mV / (1/min)	UINT32	RO	0x00000000 (0 _{dec})
9009:10	Winding resistance Ph-Ph 20°C	Coil resistance Unit: mOhm	UINT16	RO	0x0000 (0 _{dec})
9009:11	Ld Ph-Ph	Inductance in the direction of flow Unit: 0.1 mH	UINT16	RO	0x0000 (0 _{dec})
9009:12	Lq Ph-Ph	Inductance in torque forming direction Unit: 0.1 mH	UINT16	RO	0x0000 (0 _{dec})
9009:13	Max speed	Maximum velocity Unit: 1/min	UINT32	RO	0x00000000 (0 _{dec})
9009:14	Moment of inertia	Mass moment of inertia Unit: g cm ²	UINT16	RO	0x0000 (0 _{dec})
9009:15	T motor warn limit	Motor temperature warning threshold Unit: 0.1 °C	UINT16	RO	0x0000 (0 _{dec})
9009:16	T motor shut down	Motor temperature error threshold Unit: 0.1 °C	UINT16	RO	0x0000 (0 _{dec})
9009:17	Time constant i2t	Time constant I2T model Unit: s	UINT16	RO	0x0000 (0 _{dec})
9009:18	Motor thermal constant	Thermal time constant of the motor Unit: s	UINT16	RO	0x0000 (0 _{dec})

9009:1B*	Brake type	Brake type • no brake • holding brake	STRING	RO	
9009:1C	Min brake voltage	Minimum brake voltage Unit: mV	UINT32	RO	0x00000000 (0 _{dec})
9009:1D	Max brake voltage	Maximum brake voltage Unit: mV	UINT32	RO	0x00000000 (0 _{dec})
9009:1E	Min brake monitor current	Minimum current for the monitoring of the brake Unit: mA	UINT32	RO	0x00000000 (0 _{dec})
9009:1F	Brake holding torque	Brake holding torque Unit: mNm	UINT32	RO	0x00000000 (0 _{dec})
9009:20	Brake T on		UINT16	RO	0x0000 (0 _{dec})
9009:21	Brake T off		UINT16	RO	0x0000 (0 _{dec})
9009:22	Brake reduced holding voltage		UINT32	RO	0x00000000 (0 _{dec})
9009:23	Brake time to red. holding volt.		UINT16	RO	0x0000 (0 _{dec})
9009:24	Motor temp sensor connection		STRING	RO	

Index 9010 DRV Info data Ch.1

Index (hex)	Name	Meaning	Data type	Flags	Default
9010:0	DRV Info data Ch.1		UINT8	RO	0x17 (23 _{dec})
9010:13	Supported drive modes	Information about supported drive modes. Only modes CSV, CST, CSTCA and CSP are supported Bit 0: PP Bit 1: VL Bit 2: PV Bit 3: TQ Bit 4: R Bit 5: HM Bit 6: IP Bit 7: CSP Bit 8: CSV Bit 9: CST Bit 10: CSTCA Bit 11 - 15: reserved Bit 16-31: Manufacturer-specific	UINT32	RO	0x00000000 (0 _{dec})
9010:14	Velocity encoder resolution	Display of the configured encoder increments / s and motor revolutions / s. The "Velocity Encoder Resolution" is calculated according to the following formula: Velocity Encoder Resolution = (encoder_increments / s) / (motor_revolutions / s)	UINT32	RO	0x00000000 (0 _{dec})
9010:15	Position encoder resolution increments	Feedback increments per motor revolution	UINT32	RO	0x00000000 (0 _{dec})
9010:17	Cogging compensation supported	The cogging compensation data are available in the motor's electronic identification plate.	BOOLEAN	RO	0x00 (0 _{dec})

Index 9108 FB OCT Info data Ch.2 (ELM72x2 only)

Index (hex)	Name	Meaning	Data type	Flags	Default
9108:0	FB OCT Info data Ch.2		UINT8	RO	0x20 (32 _{dec})
9108:11	Encoder Type	Feedback type 2: rotary encoder, unipolar counting	UINT16	RO	0x0000 (0 _{dec})
9108:12	Resolution	Resolution of the feedback. Unit: steps per revolution	UINT32	RO	0x00000000 (0 _{dec})
9108:13	Range	Working area of the feedback. On leaving this range there is an overflow of the position. Unit: revolutions	UINT32	RO	0x00000000 (0 _{dec})
9108:14	Type Code Name	Name of the feedback.	STRING	RO	
9108:15	Serial No	Serial number of the feedback	STRING	RO	
9108:16	Firmware Revision No	Revision of the firmware.	STRING	RO	
9108:17	Firmware Date	Date of the firmware.	STRING	RO	
9108:18	EEPROM Size	EEPROM size.	UINT16	RO	0x0000 (0 _{dec})
9108:19	Temperature	Temperature. Unit: 0.1 °C	INT16	RO	0x0000 (0 _{dec})
9108:1A	LED Current	Current of the feedback LED. Unit: 0.1 mA	UINT16	RO	0x0000 (0 _{dec})
9108:1B*	Supply voltage	Supply voltage of the feedback. Unit: mV	UINT32	RO	0x00000000 (0 _{dec})
9108:1C	Life- time	Operating hours counter. Unit: minutes	UINT32	RO	0x00000000 (0 _{dec})
9108:1D	Received Signal Strength Indicator	Received signal strength at the terminal. Unit: %	UINT16	RO	0x0000 (0 _{dec})
9108:1E	Slave Received Signal Strength Indicator	Received signal strength at the encoder. Unit: %	UINT16	RO	0x0000 (0 _{dec})
9108:1F	Line delay	Running time of the signal in the cable. Unit: ns	UINT16	RO	0x0000 (0 _{dec})
9108:20	Encoder position offset	Position offset stored in the motor feedback.	UINT32	RO	0x00000000 (0 _{dec})

Index 9109 FB OCT Nameplate Ch.2 (ELM72x2 only)

The parameters described in this index are always read from the electronic identification plate of the connected motor.

With these parameters some configuration parameters can be set automatically. See chapter [Configuration data \[► 67\]](#).

Index (hex)	Name	Meaning	Data type	Flags	Default
9109:0	FB OCT Nameplate Ch.2		UINT8	RO	0x24 (36 _{dec})
9109:01	Motor vendor	Motor vendor	STRING	RO	
9109:02	Electric motor type	Motor type	STRING	RO	
9109:03	Serial No	Serial number	STRING	RO	
9109:04	Order code	Order number	STRING	RO	
9109:05	Motor construction	Type of motor	STRING	RO	
9109:06	Pole pairs	Number of pole pairs	UINT32	RO	0x00000000 (0 _{dec})
9109:07	Standstill current (rms)	Effective holding current Unit: mA	UINT32	RO	0x00000000 (0 _{dec})
9109:08	Rated current (rms)	Effective nominal current Unit: mA	UINT32	RO	0x00000000 (0 _{dec})
9109:09	Peak current (rms)	Effective peak current Unit: mA	UINT32	RO	0x00000000 (0 _{dec})

9109:0A	Nominal voltage (rms)	Effective nominal voltage Unit: mV	UINT32	RO	0x00000000 (0 _{dec})
9109:0B	Max voltage (rms)	Maximum voltage Unit: mV	UINT32	RO	0x00000000 (0 _{dec})
9109:0C	Max winding du/dt	Maximum permissible voltage rise on the winding Unit: kV / s	UINT32	RO	0x00000000 (0 _{dec})
9109:0D	Max torque	Maximum torque Unit: mNm	UINT16	RO	0x0000 (0 _{dec})
9109:0E	Torque constant	Torque constant Unit: mNm / A	UINT16	RO	0x0000 (0 _{dec})
9109:0F	EMF (rms)	Countervoltage Unit: mV / (1/min)	UINT32	RO	0x00000000 (0 _{dec})
9109:10	Winding resistance Ph-Ph 20°C	Coil resistance Unit: mOhm	UINT16	RO	0x0000 (0 _{dec})
9109:11	Ld Ph-Ph	Inductance in the direction of flow Unit: 0.1 mH	UINT16	RO	0x0000 (0 _{dec})
9109:12	Lq Ph-Ph	Inductance in torque forming direction Unit: 0.1 mH	UINT16	RO	0x0000 (0 _{dec})
9109:13	Max speed	Maximum velocity Unit: 1/min	UINT32	RO	0x00000000 (0 _{dec})
9109:14	Moment of inertia	Mass moment of inertia Unit: g cm ²	UINT16	RO	0x0000 (0 _{dec})
9109:15	T motor warn limit	Motor temperature warning threshold Unit: 0.1 °C	UINT16	RO	0x0000 (0 _{dec})
9109:16	T motor shut down	Motor temperature error threshold Unit: 0.1 °C	UINT16	RO	0x0000 (0 _{dec})
9109:17	Time constant i2t	Time constant I2T model Unit: s	UINT16	RO	0x0000 (0 _{dec})
9109:18	Motor thermal constant	Thermal time constant of the motor Unit: s	UINT16	RO	0x0000 (0 _{dec})
9109:1B*	Brake type	Brake type <ul style="list-style-type: none"> • no brake • holding brake 	STRING	RO	
9109:1C	Min brake voltage	Minimum brake voltage Unit: mV	UINT32	RO	0x00000000 (0 _{dec})
9109:1D	Max brake voltage	Maximum brake voltage Unit: mV	UINT32	RO	0x00000000 (0 _{dec})
9109:1E	Min brake monitor current	Minimum current for the monitoring of the brake Unit: mA	UINT32	RO	0x00000000 (0 _{dec})
9109:1F	Brake holding torque	Brake holding torque Unit: mNm	UINT32	RO	0x00000000 (0 _{dec})
9109:20	Brake T on		UINT16	RO	0x0000 (0 _{dec})
9109:21	Brake T off		UINT16	RO	0x0000 (0 _{dec})
9109:22	Brake reduced holding voltage		UINT32	RO	0x00000000 (0 _{dec})
9109:23	Brake time to red. holding volt.		UINT16	RO	0x0000 (0 _{dec})
9109:24	Motor temp sensor connection		STRING	RO	

Index 9110 DRV Info data Ch.2 (ELM72x2 only)

Index (hex)	Name	Meaning	Data type	Flags	Default
9110:0	DRV Info data Ch.2		UINT8	RO	0x17 (23 _{dec})
9110:13	Supported drive modes	Information about supported drive modes. Only modes CSV, CST, CSTCA and CSP are supported Bit 0: PP Bit 1: VL Bit 2: PV Bit 3: TQ Bit 4: R Bit 5: HM Bit 6: IP Bit 7: CSP Bit 8: CSV Bit 9: CST Bit 10: CSTCA Bit 11 - 15: reserved Bit 16-31: Manufacturer-specific	UINT32	RO	0x00000000 (0 _{dec})
9110:14	Velocity encoder resolution	Display of the configured encoder increments / s and motor revolutions / s. The "Velocity Encoder Resolution" is calculated according to the following formula: Velocity Encoder Resolution = (encoder_increments / s) / (motor_revolutions / s)	UINT32	RO	0x00000000 (0 _{dec})
9110:15	Position encoder resolution increments	Feedback increments per motor revolution	UINT32	RO	0x00000000 (0 _{dec})
9110:17	Cogging compensation supported	The cogging compensation data are available in the motor's electronic identification plate.	BOOLEAN	RO	0x00 (0 _{dec})

Index A010 DRV Amplifier Diag data Ch.1

Index (hex)	Name	Meaning	Data type	Flags	Default
010A:0	DRV Amplifier Diag data Ch.1		UINT8	RO	0x11 (17 _{dec})
010A:11	Amplifier I2T temperature	I2T model load Unit: %	UINT8	RO	0x00 (0 _{dec})

Index A011 DRV Motor Diag data Ch.1

Index (hex)	Name	Meaning	Data type	Flags	Default
011A:0	DRV Motor Diag data Ch.1		UINT8	RO	0x13 (19 _{dec})
011A:11	Motor I2T temperature	I2T model load Unit: %	UINT8	RO	0x00 (0 _{dec})
011A:13	Motor temperature	Temperature utilization ratio Unit: °C	INT16	RO	0x0000 (0 _{dec})

Index A110 DRV Amplifier Diag data Ch.2 (ELM72x2 only)

Index (hex)	Name	Meaning	Data type	Flags	Default
110A:0	DRV Amplifier Diag data Ch.2		UINT8	RO	0x11 (17 _{dec})
110A:11	Amplifier I2T temperature	I2T model load Unit: %	UINT8	RO	0x00 (0 _{dec})

Index A111 DRV Motor Diag data Ch.2 (ELM72x2 only)

Index (hex)	Name	Meaning	Data type	Flags	Default
111A:0	DRV Motor Diag data Ch.2		UINT8	RO	0x13 (19 _{dec})
111A:11	Motor I2T temperature	I2T model load Unit: %	UINT8	RO	0x00 (0 _{dec})
111A:13	Motor temperature	Temperature utilization ratio Unit: °C	INT16	RO	0x0000 (0 _{dec})

Index B001 FB OCT Memory interface Ch.1

Index (hex)	Name	Meaning	Data type	Flags	Default
B001:0	FB OCT Memory interface Ch.1		UINT8	RO	0x06 (6 _{dec})
B001:01	Cmd	Permitted values: <ul style="list-style-type: none"> • 3_{dec}: Enc Write • 6_{dec}: Enc Read Direct • 7_{dec}: Enc Read Indirect • 9_{dec}: Enc Reset • 10_{dec}: IP Write • 15_{dec}: IP Read • 16_{dec}: Write encoder position offset 	UINT16	RW	0x0007 (7 _{dec})
B001:02	Len		UINT16	RW	0x0000 (0 _{dec})
B001:03	Adr		UINT32	RW	0x00000000 (0 _{dec})
B001:04	Offset		UINT32	RW	0x00000000 (0 _{dec})
B001:05	Ctrl/Status	Permitted values: <ul style="list-style-type: none"> • 0_{dec}: Init • 1_{dec}: Execute • 2_{dec}: Busy • 3_{dec}: Done • 4_{dec}: Error 	UINT16	RW	0x0000 (0 _{dec})
001B:06	Data		OCTET-STRING[32]	RW	{0}

Index B101 FB OCT Memory interface Ch.2 (ELM72x2 only)

Index (hex)	Name	Meaning	Data type	Flags	Default
B101:0	FB OCT Memory interface Ch.2		UINT8	RO	0x06 (6 _{dec})
101B:01	Cmd	Permitted values: <ul style="list-style-type: none"> • 3_{dec}: Enc Write • 6_{dec}: Enc Read Direct • 7_{dec}: Enc Read Indirect • 9_{dec}: Enc Reset • 10_{dec}: IP Write • 15_{dec}: IP Read • 16_{dec}: Write encoder position offset 	UINT16	RW	0x0007 (7 _{dec})
101B:02	Len		UINT16	RW	0x0000 (0 _{dec})
101B:03	Adr		UINT32	RW	0x00000000 (0 _{dec})
101B:04	Offset		UINT32	RW	0x00000000 (0 _{dec})
101B:05	Ctrl/Status	Permitted values: <ul style="list-style-type: none"> • 0_{dec}: Init • 1_{dec}: Execute • 2_{dec}: Busy • 3_{dec}: Done • 4_{dec}: Error 	UINT16	RW	0x0000 (0 _{dec})
101B:06	Data		OCTET-STRING[32]	RW	{0}

Index F900 DRV Info data

Index (hex)	Name	Meaning	Data type	Flags	Default
F900:0	DRV Info data		UINT8	RO	0x14 (20 _{dec})
F900:11	Amplifier temperature	Internal temperature of the terminal. Unit: 0.1 °C	INT16	RO	0x0000 (0 _{dec})
F900:12	DC link voltage	Measured value of the DC link voltage. Unit: mV	UINT32	RO	0x00000000 (0 _{dec})
F900:13	Supply voltage U _p	Measured value of the supply voltage U _p	UINT32	RO	0x00000000 (0 _{dec})
F900:14	Digital inputs	Bit vector of the digital inputs [0] TP1, Ch1 [1] TP2, Ch1 [8] TP2, Ch2 (for ELM72x2) [9] TP2, Ch2 (for ELM72x2)	UINT16	RO	0x0000 (0 _{dec})

Index F913 DRV Device Info data

Index (hex)	Name	Meaning	Data type	Flags	Default
F913:0	DRV Device Info data		UINT8	RO	0x04 (4 _{dec})
F913:01	HW config		STRING	RO	
F913:03	FW info		STRING	RO	
F913:04	DMC version		STRING	RO	

9.2.7 Standard objects

Index 1000 Device type

Index (hex)	Name	Meaning	Data type	Flags	Default
1000:0	Device type	Device type of the EtherCAT slave: the Lo-Word contains the used CoE profile (5001). The Hi-Word contains the module profile according to the modular device profile.	UINT32	RO	0x00001389 (5001 _{dec})

Index 1008 Device name

Index (hex)	Name	Meaning	Data type	Flags	Default
1008:0	Device name	Device name of the EtherCAT slave	STRING	RO	¹⁾

¹⁾ The default value corresponds to the product name:

- "ELM7211-0010"
- "ELM7212-0010"
- "ELM7221-0010"
- "ELM7222-0010"
- "ELM7231-0010"

Index 1009 Hardware version

Index (hex)	Name	Meaning	Data type	Flags	Default
1009:0	Hardware version	Hardware version of the EtherCAT slave	STRING	RO	

Index 100A Software version

Index (hex)	Name	Meaning	Data type	Flags	Default
100A:0	Software version	Firmware version of the EtherCAT slave	STRING	RO	01

Index 100B Bootloader version

Index (hex)	Name	Meaning	Data type	Flags	Default
B100:0	Bootloader version		STRING	RO	N/A

Index 1011 Restore default parameters

Index (hex)	Name	Meaning	Data type	Flags	Default
1011:0	Restore default parameters	Restore default settings	UINT8	RO	0x01 (1 _{dec})
1011:01	SubIndex 001	If this object is set to "0x64616F6C" in the set value dialog, all backup objects are reset to their delivery state.	UINT32	RW	0x00000000 (0 _{dec})

Index 1018 Identity

Index (hex)	Name	Meaning	Data type	Flags	Default
1018:0	Identity	Information for identifying the slave	UINT8	RO	0x04 (4 _{dec})
1018:01	Vendor ID	Vendor ID of the EtherCAT slave	UINT32	RO	0x00000002 (2 _{dec})
1018:02	Product code	Product code of the EtherCAT slave	UINT32	RO	¹⁾
1018:03	Revision	Revision number of the EtherCAT slave; the Low Word (bit 0-15) indicates the special terminal number, the High Word (bit 16-31) refers to the device description	UINT32	RO	0x00000000 (0 _{dec})
1018:04	Serial number	Serial number of the EtherCAT slave; the Low Byte (bit 0-7) of the Low Word contains the year of production, the High Byte (bit 8-15) of the Low Word contains the week of production, the High Word (bit 16-31) is 0	UINT32	RO	0x00000000 (0 _{dec})

¹⁾ The default value of "Product code" varies depending on the product:

- ELM7211-0010: 0x502274B9 (1344435385_{dec})
- ELM7212-0010: 0x502274C9 (1344435401_{dec})
- ELM7221-0010: 0x50227559 (1344435545_{dec})
- ELM7222-0010: 0x50227569 (1344435561_{dec})
- ELM7231-0010: 0x502275F9 (1344435705_{dec})

Index 10E2 Manufacturer-specific Identification Code

Index (hex)	Name	Meaning	Data type	Flags	Default
10E2:0	Manufacturer-specific Identification Code		UINT8	RO	0x01 (1 _{dec})
10E2:01	SubIndex 001		STRING	RO	

Index 10F0 Backup parameter handling

Index (hex)	Name	Meaning	Data type	Flags	Default
10F0:01	Checksum	Checksum across all backup entries of the EtherCAT slave	UINT32	RO	0x00000000 (0 _{dec})

Index 10F8 Timestamp Object

Index (hex)	Name	Meaning	Data type	Flags	Default
10F8:0	Timestamp Object		UINT64	RO	

Index 1420 DMC RxPDO-Par Outputs Ch.1

Index (hex)	Name	Meaning	Data type	Flags	Default
1420:0	DMC RxPDO-Par Outputs Ch.1	PDO Parameter RxPDO 33	UINT8	RO	0x06 (6 _{dec})
1420:06	Exclude RxPDOs	Specifies the RxPDOs (index of RxPDO mapping objects) that must not be transferred together with RxPDO 33	OCTET-STRING[2]	RO	21 16

Index 1421 DMC RxPDO-Par Outputs 32 Bit Ch.1

Index (hex)	Name	Meaning	Data type	Flags	Default
1421:0	DMC RxPDO-Par Outputs 32 Bit Ch.1	PDO Parameter RxPDO 34	UINT8	RO	0x06 (6 _{dec})
1421:06	Exclude RxPDOs	Specifies the RxPDOs (index of RxPDO mapping objects) that must not be transferred together with RxPDO 34	OCTET-STRING[2]	RO	20 16

Index 1460 DMC RxPDO-Par Outputs Ch.2

Index (hex)	Name	Meaning	Data type	Flags	Default
1460:0	DMC RxPDO-Par Outputs Ch.2	PDO Parameter RxPDO 97	UINT8	RO	0x06 (6 _{dec})
1460:06	Exclude RxPDOs	Specifies the RxPDOs (index of RxPDO mapping objects) that must not be transferred together with RxPDO 97	OCTET-STRING[2]	RO	61 16

Index 1461 DMC RxPDO-Par Outputs 32 Bit Ch.2

Index (hex)	Name	Meaning	Data type	Flags	Default
1461:0	DMC RxPDO-Par Outputs 32 Bit Ch.2	PDO Parameter RxPDO 98	UINT8	RO	0x06 (6 _{dec})
1461:06	Exclude RxPDOs	Specifies the RxPDOs (index of RxPDO mapping objects) that must not be transferred together with RxPDO 98	OCTET-STRING[2]	RO	60 16

Index 1600 FB RxPDO-Map Touch probe control Ch.1

Index (hex)	Name	Meaning	Data type	Flags	Default
1600:0	FB RxPDO-Map Touch probe control Ch.1	PDO Mapping RxPDO 1	UINT8	RO	0x0C (12 _{dec})
1600:01	SubIndex 001	1. PDO Mapping entry (object 0x7001 (FB Touch probe outputs Ch.1), entry 0x01 (TP1 Enable))	UINT32	RO	0x7001:01, 1
1600:02	SubIndex 002	2. PDO Mapping entry (object 0x7001 (FB Touch probe outputs Ch.1), entry 0x02 (TP1 Continuous))	UINT32	RO	0x7001:02, 1
1600:03	SubIndex 003	3. PDO Mapping entry (object 0x7001 (FB Touch probe outputs Ch.1), entry 0x03 (TP1 Trigger mode))	UINT32	RO	0x7001:03, 2
1600:04	SubIndex 004	4. PDO Mapping entry (object 0x7001 (FB Touch probe outputs Ch.1), entry 0x05 (TP1 Enable pos edge))	UINT32	RO	0x7001:05, 1
1600:05	SubIndex 005	5. PDO Mapping entry (object 0x7001 (FB Touch probe outputs Ch.1), entry 0x06 (TP1 Enable neg edge))	UINT32	RO	0x7001:06, 1
1600:06	SubIndex 006	6. PDO Mapping entry (2 bits align)	UINT32	RO	0x0000:00, 2
1600:07	SubIndex 007	7. PDO Mapping entry (object 0x7001 (FB Touch probe outputs Ch.1), entry 0x09 (TP2 Enable))	UINT32	RO	0x7001:09, 1
1600:08	SubIndex 008	8. PDO Mapping entry (object 0x7001 (FB Touch probe outputs Ch.1), entry 0x0A (TP2 Continuous))	UINT32	RO	0x7001:0A, 1
1600:09	SubIndex 009	9. PDO Mapping entry (object 0x7001 (FB Touch probe outputs Ch.1), entry 0x0B (TP2 Trigger mode))	UINT32	RO	0x7001:0B, 2
1600:0A	SubIndex 010	10. PDO Mapping entry (object 0x7001 (FB Touch probe outputs Ch.1), entry 0x0D (TP2 Enable pos edge))	UINT32	RO	0x7001:0D, 1
1600:0B	SubIndex 011	11. PDO Mapping entry (object 0x7001 (FB Touch probe outputs Ch.1), entry 0x0E (TP2 Enable neg edge))	UINT32	RO	0x7001:0E, 1
1600:0C	SubIndex 012	12. PDO Mapping entry (2 bits align)	UINT32	RO	0x0000:00, 2

Index 1610 DRV RxPDO-Map Controlword Ch.1

Index (hex)	Name	Meaning	Data type	Flags	Default
1610:0	DRV RxPDO-Map Controlword Ch.1	PDO Mapping RxPDO 17	UINT8	RO	0x01 (1 _{dec})
1610:01	SubIndex 001	1. PDO Mapping entry (object 0x7010 (DRV Outputs Ch.1), entry 0x01 (Controlword))	UINT32	RO	0x7010:01, 16

Index 1611 DRV RxPDO-Map Target position Ch.1

Index (hex)	Name	Meaning	Data type	Flags	Default
1611:0	DRV RxPDO-Map Target position Ch.1	PDO Mapping RxPDO 18	UINT8	RO	0x01 (1 _{dec})
1611:01	SubIndex 001	1. PDO Mapping entry (object 0x7010 (DRV Outputs Ch.1), entry 0x05 (Target position))	UINT32	RO	0x7010:05, 32

Index 1612 DRV RxPDO-Map Target velocity Ch.1

Index (hex)	Name	Meaning	Data type	Flags	Default
1612:0	DRV RxPDO-Map Target velocity Ch.1	PDO Mapping RxPDO 19	UINT8	RO	0x01 (1 _{dec})
1612:01	SubIndex 001	1. PDO Mapping entry (object 0x7010 (DRV Outputs Ch.1), entry 0x06 (Target velocity))	UINT32	RO	0x7010:06, 32

Index 1613 DRV RxPDO-Map Target torque Ch.1

Index (hex)	Name	Meaning	Data type	Flags	Default
1613:0	DRV RxPDO-Map Target torque Ch.1	PDO Mapping RxPDO 20	UINT8	RO	0x01 (1 _{dec})
1613:01	SubIndex 001	1. PDO Mapping entry (object 0x7010 (DRV Outputs Ch.1), entry 0x09 (Target torque))	UINT32	RO	0x7010:09, 16

Index 1614 DRV RxPDO-Map Commutation angle Ch.1

Index (hex)	Name	Meaning	Data type	Flags	Default
1614:0	DRV RxPDO-Map Commutation angle Ch.1	PDO Mapping RxPDO 21	UINT8	RO	0x01 (1 _{dec})
1614:01	SubIndex 001	1. PDO Mapping entry (object 0x7010 (DRV Outputs Ch.1), entry 0x0E (Commutation angle))	UINT32	RO	0x7010:0E, 16

Index 1615 DRV RxPDO-Map Velocity offset Ch.1

Index (hex)	Name	Meaning	Data type	Flags	Default
1615:0	DRV RxPDO-Map Velocity offset Ch.1	PDO Mapping RxPDO 22	UINT8	RO	0x01 (1 _{dec})
1615:01	SubIndex 001	1. PDO Mapping entry (object 0x7010 (DRV Outputs Ch.1), entry 0x0F (Velocity offset))	UINT32	RO	0x7010:0F, 32

Index 1616 DRV RxPDO-Map Torque offset Ch.1

Index (hex)	Name	Meaning	Data type	Flags	Default
1616:0	DRV RxPDO-Map Torque offset Ch.1	PDO Mapping RxPDO 23	UINT8	RO	0x01 (1 _{dec})
1616:01	SubIndex 001	1. PDO Mapping entry (object 0x7010 (DRV Outputs Ch.1), entry 0x0A (Torque offset))	UINT32	RO	0x7010:0A, 16

Index 1617 DRV RxPDO-Map Torque limitation Ch.1

Index (hex)	Name	Meaning	Data type	Flags	Default
1617:0	DRV RxPDO-Map Torque limitation Ch.1	PDO Mapping RxPDO 24	UINT8	RO	0x01 (1 _{dec})
1617:01	SubIndex 001	1. PDO Mapping entry (object 0x7010 (DRV Outputs Ch.1), entry 0x0B (Torque limitation))	UINT32	RO	0x7010:0B, 16

Index 1618 DRV RxPDO-Map Positive torque limit value Ch.1

Index (hex)	Name	Meaning	Data type	Flags	Default
1618:0	DRV RxPDO-Map Positive torque limit value Ch.1	PDO Mapping RxPDO 25	UINT8	RO	0x01 (1 _{dec})
1618:01	SubIndex 001	1. PDO Mapping entry (object 0x7010 (DRV Outputs Ch.1), entry 0x10 (Positive torque limit value))	UINT32	RO	0x7010:10, 16

Index 1619 DRV RxPDO-Map Negative torque limit value Ch.1

Index (hex)	Name	Meaning	Data type	Flags	Default
1619:0	DRV RxPDO-Map Negative torque limit value Ch.1	PDO Mapping RxPDO 26	UINT8	RO	0x01 (1 _{dec})
1619:01	SubIndex 001	1. PDO Mapping entry (object 0x7010 (DRV Outputs Ch.1), entry 0x11 (Negative torque limit value))	UINT32	RO	0x7010:11, 16

Index 161A DRV RxPDO-Map Modes of operation Ch.1

Index (hex)	Name	Meaning	Data type	Flags	Default
161A:0	DRV RxPDO-Map Modes of operation Ch.1	PDO Mapping RxPDO 27	UINT8	RO	0x01 (1 _{dec})
161A:01	SubIndex 001	1. PDO Mapping entry (object 0x7010 (DRV Outputs Ch.1), entry 0x03 (Modes of operation))	UINT32	RO	0x7010:03, 8

Index 161B DRV RxPDO-Map Low velocity limit value Ch.1

Index (hex)	Name	Meaning	Data type	Flags	Default
B161:0	DRV RxPDO-Map Low velocity limit value Ch.1	PDO Mapping RxPDO 28	UINT8	RO	0x01 (1 _{dec})
161B:01	SubIndex 001	1. PDO Mapping entry (object 0x7010 (DRV Outputs Ch.1), entry 0x12 (Low velocity limit value))	UINT32	RO	0x7010:12, 32

Index 161C DRV RxPDO-Map High velocity limit value Ch.1

Index (hex)	Name	Meaning	Data type	Flags	Default
161C:0	DRV RxPDO-Map High velocity limit value Ch.1	PDO Mapping RxPDO 29	UINT8	RO	0x01 (1 _{dec})
161C:01	SubIndex 001	1. PDO Mapping entry (object 0x7010 (DRV Outputs Ch.1), entry 0x13 (High velocity limit value))	UINT32	RO	0x7010:13, 32

Index 1620 DMC RxPDO-Map Outputs Ch.1

Index (hex)	Name	Meaning	Data type	Flags	Default
1620:0	DMC RxPDO-Map Outputs Ch.1	PDO Mapping RxPDO 33	UINT8	RO	0x12 (18 _{dec})
1620:01	SubIndex 001	1. PDO Mapping entry (1 bits align)	UINT32	RO	0x0000:00, 1
1620:02	SubIndex 002	2. PDO Mapping entry (object 0x7020 (DMC Outputs Ch.1), entry 0x02 (DMC__FeedbackControl__Enable latch extern on positive edge))	UINT32	RO	0x7020:02, 1
1620:03	SubIndex 003	3. PDO Mapping entry (object 0x7020 (DMC Outputs Ch.1), entry 0x03 (DMC__FeedbackControl__Set counter))	UINT32	RO	0x7020:03, 1
1620:04	SubIndex 004	4. PDO Mapping entry (object 0x7020 (DMC Outputs Ch.1), entry 0x04 (DMC__FeedbackControl__Enable latch extern on negative edge))	UINT32	RO	0x7020:04, 1
1620:05	SubIndex 005	5. PDO Mapping entry (12 bits align)	UINT32	RO	0x0000:00, 12
1620:06	SubIndex 006	6. PDO Mapping entry (object 0x7020 (DMC Outputs Ch.1), entry 0x11 (DMC__DriveControl__Enable))	UINT32	RO	0x7020:11, 1
1620:07	SubIndex 007	7. PDO Mapping entry (object 0x7020 (DMC Outputs Ch.1), entry 0x12 (DMC__DriveControl__Reset))	UINT32	RO	0x7020:12, 1
1620:08	SubIndex 008	8. PDO Mapping entry (14 bits align)	UINT32	RO	0x0000:00, 14
1620:09	SubIndex 009	9. PDO Mapping entry (object 0x7020 (DMC Outputs Ch.1), entry 0x21 (DMC__PositioningControl__Execute))	UINT32	RO	0x7020:21, 1
1620:0A	SubIndex 010	10. PDO Mapping entry (object 0x7020 (DMC Outputs Ch.1), entry 0x22 (DMC__PositioningControl__Emergency stop))	UINT32	RO	0x7020:22, 1
1620:0B	SubIndex 011	11. PDO Mapping entry (14 bits align)	UINT32	RO	0x0000:00, 14
1620:0C	SubIndex 012	12. PDO Mapping entry (object 0x7020 (DMC Outputs Ch.1), entry 0x31 (DMC__Set counter value))	UINT32	RO	0x7020:31, 64
1620:0D	SubIndex 013	13. PDO Mapping entry (object 0x7020 (DMC Outputs Ch.1), entry 0x32 (DMC__Target position))	UINT32	RO	0x7020:32, 64
1620:0E	SubIndex 014	14. PDO Mapping entry (object 0x7020 (DMC Outputs Ch.1), entry 0x33 (DMC__Target velocity))	UINT32	RO	0x7020:33, 16
1620:0F	SubIndex 015	15. PDO Mapping entry (object 0x7020 (DMC Outputs Ch.1), entry 0x34 (DMC__Start type))	UINT32	RO	0x7020:34, 16
1620:10	SubIndex 016	16. PDO Mapping entry (object 0x7020 (DMC Outputs Ch.1), entry 0x35 (DMC__Target acceleration))	UINT32	RO	0x7020:35, 16
1620:11	SubIndex 017	17. PDO Mapping entry (object 0x7020 (DMC Outputs Ch.1), entry 0x36 (DMC__Target deceleration))	UINT32	RO	0x7020:36, 16
1620:12	SubIndex 018	18. PDO Mapping entry (80 bits align)	UINT32	RO	0x0000:00, 80

Index 1621 DMC RxPDO-Map Outputs 32 Bit Ch.1

Index (hex)	Name	Meaning	Data type	Flags	Default
1621:0	DMC RxPDO-Map Outputs 32 Bit Ch.1	PDO Mapping RxPDO 34	UINT8	RO	0x14 (20 _{dec})
1621:01	SubIndex 001	1. PDO Mapping entry (1 bits align)	UINT32	RO	0x0000:00, 1
1621:02	SubIndex 002	2. PDO Mapping entry (object 0x7020 (DMC Outputs Ch.1), entry 0x02 (DMC__FeedbackControl__Enable latch extern on positive edge))	UINT32	RO	0x7020:02, 1
1621:03	SubIndex 003	3. PDO Mapping entry (object 0x7020 (DMC Outputs Ch.1), entry 0x03 (DMC__FeedbackControl__Set counter))	UINT32	RO	0x7020:03, 1
1621:04	SubIndex 004	4. PDO Mapping entry (object 0x7020 (DMC Outputs Ch.1), entry 0x04 (DMC__FeedbackControl__Enable latch extern on negative edge))	UINT32	RO	0x7020:04, 1
1621:05	SubIndex 005	5. PDO Mapping entry (12 bits align)	UINT32	RO	0x0000:00, 12
1621:06	SubIndex 006	6. PDO Mapping entry (object 0x7020 (DMC Outputs Ch.1), entry 0x11 (DMC__DriveControl__Enable))	UINT32	RO	0x7020:11, 1
1621:07	SubIndex 007	7. PDO Mapping entry (object 0x7020 (DMC Outputs Ch.1), entry 0x12 (DMC__DriveControl__Reset))	UINT32	RO	0x7020:12, 1
1621:08	SubIndex 008	8. PDO Mapping entry (14 bits align)	UINT32	RO	0x0000:00, 14
1621:09	SubIndex 009	9. PDO Mapping entry (object 0x7020 (DMC Outputs Ch.1), entry 0x21 (DMC__PositioningControl__Execute))	UINT32	RO	0x7020:21, 1
1621:0A	SubIndex 010	10. PDO Mapping entry (object 0x7020 (DMC Outputs Ch.1), entry 0x22 (DMC__PositioningControl__Emergency stop))	UINT32	RO	0x7020:22, 1
1621:0B	SubIndex 011	11. PDO Mapping entry (14 bits align)	UINT32	RO	0x0000:00, 14
1621:0C	SubIndex 012	12. PDO Mapping entry (object 0x7020 (DMC Outputs Ch.1), entry 0x31 (DMC__Set counter value))	UINT32	RO	0x7020:31, 32
1621:0D	SubIndex 013	13. PDO Mapping entry (32 bits align)	UINT32	RO	0x0000:00, 32
1621:0E	SubIndex 014	14. PDO Mapping entry (object 0x7020 (DMC Outputs Ch.1), entry 0x32 (DMC__Target position))	UINT32	RO	0x7020:32, 32
1621:0F	SubIndex 015	15. PDO Mapping entry (32 bits align)	UINT32	RO	0x0000:00, 32
1621:10	SubIndex 016	16. PDO Mapping entry (object 0x7020 (DMC Outputs Ch.1), entry 0x33 (DMC__Target velocity))	UINT32	RO	0x7020:33, 16
1621:11	SubIndex 017	17. PDO Mapping entry (object 0x7020 (DMC Outputs Ch.1), entry 0x34 (DMC__Start type))	UINT32	RO	0x7020:34, 16
1621:12	SubIndex 018	18. PDO Mapping entry (object 0x7020 (DMC Outputs Ch.1), entry 0x35 (DMC__Target acceleration))	UINT32	RO	0x7020:35, 16
1621:13	SubIndex 019	19. PDO Mapping entry (object 0x7020 (DMC Outputs Ch.1), entry 0x36 (DMC__Target deceleration))	UINT32	RO	0x7020:36, 16
1621:14	SubIndex 020	20. PDO Mapping entry (80 bits align)	UINT32	RO	0x0000:00, 80

Index 1640 FB RxPDO-Map Touch probe control Ch.2

Index (hex)	Name	Meaning	Data type	Flags	Default
1640:0	FB RxPDO-Map Touch probe control Ch.2	PDO Mapping RxPDO 65	UINT8	RO	0x0C (12 _{dec})
1640:01	SubIndex 001	1. PDO Mapping entry (object 0x7101 (FB Touch probe outputs Ch.2), entry 0x01 (TP1 Enable))	UINT32	RO	0x7101:01, 1
1640:02	SubIndex 002	2. PDO Mapping entry (object 0x7101 (FB Touch probe outputs Ch.2), entry 0x02 (TP1 Continuous))	UINT32	RO	0x7101:02, 1
1640:03	SubIndex 003	3. PDO Mapping entry (object 0x7101 (FB Touch probe outputs Ch.2), entry 0x03 (TP1 Trigger mode))	UINT32	RO	0x7101:03, 2
1640:04	SubIndex 004	4. PDO Mapping entry (object 0x7101 (FB Touch probe outputs Ch.2), entry 0x05 (TP1 Enable pos edge))	UINT32	RO	0x7101:05, 1
1640:05	SubIndex 005	5. PDO Mapping entry (object 0x7101 (FB Touch probe outputs Ch.2), entry 0x06 (TP1 Enable neg edge))	UINT32	RO	0x7101:06, 1
1640:06	SubIndex 006	6. PDO Mapping entry (2 bits align)	UINT32	RO	0x0000:00, 2
1640:07	SubIndex 007	7. PDO Mapping entry (object 0x7101 (FB Touch probe outputs Ch.2), entry 0x09 (TP2 Enable))	UINT32	RO	0x7101:09, 1
1640:08	SubIndex 008	8. PDO Mapping entry (object 0x7101 (FB Touch probe outputs Ch.2), entry 0x0A (TP2 Continuous))	UINT32	RO	0x7101:0A, 1
1640:09	SubIndex 009	9. PDO Mapping entry (object 0x7101 (FB Touch probe outputs Ch.2), entry 0x0B (TP2 Trigger mode))	UINT32	RO	0x7101:0B, 2
1640:0A	SubIndex 010	10. PDO Mapping entry (object 0x7101 (FB Touch probe outputs Ch.2), entry 0x0D (TP2 Enable pos edge))	UINT32	RO	0x7101:0D, 1
1640:0B	SubIndex 011	11. PDO Mapping entry (object 0x7101 (FB Touch probe outputs Ch.2), entry 0x0E (TP2 Enable neg edge))	UINT32	RO	0x7101:0E, 1
1640:0C	SubIndex 012	12. PDO Mapping entry (2 bits align)	UINT32	RO	0x0000:00, 2

Index 1650 DRV RxPDO-Map Controlword Ch.2

Index (hex)	Name	Meaning	Data type	Flags	Default
1650:0	DRV RxPDO-Map Controlword Ch.2	PDO Mapping RxPDO 81	UINT8	RO	0x01 (1 _{dec})
1650:01	SubIndex 001	1. PDO Mapping entry (object 0x7110 (DRV Outputs Ch.2), entry 0x01 (Controlword))	UINT32	RO	0x7110:01, 16

Index 1651 DRV RxPDO-Map Target position Ch.2

Index (hex)	Name	Meaning	Data type	Flags	Default
1651:0	DRV RxPDO-Map Target position Ch.2	PDO Mapping RxPDO 82	UINT8	RO	0x01 (1 _{dec})
1651:01	SubIndex 001	1. PDO Mapping entry (object 0x7110 (DRV Outputs Ch.2), entry 0x05 (Target position))	UINT32	RO	0x7110:05, 32

Index 1652 DRV RxPDO-Map Target velocity Ch.2

Index (hex)	Name	Meaning	Data type	Flags	Default
1652:0	DRV RxPDO-Map Target velocity Ch.2	PDO Mapping RxPDO 83	UINT8	RO	0x01 (1 _{dec})
1652:01	SubIndex 001	1. PDO Mapping entry (object 0x7110 (DRV Outputs Ch.2), entry 0x06 (Target velocity))	UINT32	RO	0x7110:06, 32

Index 1653 DRV RxPDO-Map Target torque Ch.2

Index (hex)	Name	Meaning	Data type	Flags	Default
1653:0	DRV RxPDO-Map Target torque Ch.2	PDO Mapping RxPDO 84	UINT8	RO	0x01 (1 _{dec})
1653:01	SubIndex 001	1. PDO Mapping entry (object 0x7110 (DRV Outputs Ch.2), entry 0x09 (Target torque))	UINT32	RO	0x7110:09, 16

Index 1654 DRV RxPDO-Map Commutation angle Ch.2

Index (hex)	Name	Meaning	Data type	Flags	Default
1654:0	DRV RxPDO-Map Commutation angle Ch.2	PDO Mapping RxPDO 85	UINT8	RO	0x01 (1 _{dec})
1654:01	SubIndex 001	1. PDO Mapping entry (object 0x7110 (DRV Outputs Ch.2), entry 0x0E (Commutation angle))	UINT32	RO	0x7110:0E, 16

Index 1655 DRV RxPDO-Map Velocity offset Ch.2

Index (hex)	Name	Meaning	Data type	Flags	Default
1655:0	DRV RxPDO-Map Velocity offset Ch.2	PDO Mapping RxPDO 86	UINT8	RO	0x01 (1 _{dec})
1655:01	SubIndex 001	1. PDO Mapping entry (object 0x7110 (DRV Outputs Ch.2), entry 0x0F (Velocity offset))	UINT32	RO	0x7110:0F, 32

Index 1656 DRV RxPDO-Map Torque offset Ch.2

Index (hex)	Name	Meaning	Data type	Flags	Default
1656:0	DRV RxPDO-Map Torque offset Ch.2	PDO Mapping RxPDO 87	UINT8	RO	0x01 (1 _{dec})
1656:01	SubIndex 001	1. PDO Mapping entry (object 0x7110 (DRV Outputs Ch.2), entry 0x0A (Torque offset))	UINT32	RO	0x7110:0A, 16

Index 1657 DRV RxPDO-Map Torque limitation Ch.2

Index (hex)	Name	Meaning	Data type	Flags	Default
1657:0	DRV RxPDO-Map Torque limitation Ch.2	PDO Mapping RxPDO 88	UINT8	RO	0x01 (1 _{dec})
1657:01	SubIndex 001	1. PDO Mapping entry (object 0x7110 (DRV Outputs Ch.2), entry 0x0B (Torque limitation))	UINT32	RO	0x7110:0B, 16

Index 1658 DRV RxPDO-Map Positive torque limit value Ch.2

Index (hex)	Name	Meaning	Data type	Flags	Default
1658:0	DRV RxPDO-Map Positive torque limit value Ch.2	PDO Mapping RxPDO 89	UINT8	RO	0x01 (1 _{dec})
1658:01	SubIndex 001	1. PDO Mapping entry (object 0x7110 (DRV Outputs Ch.2), entry 0x10 (Positive torque limit value))	UINT32	RO	0x7110:10, 16

Index 1659 DRV RxPDO-Map Negative torque limit value Ch.2

Index (hex)	Name	Meaning	Data type	Flags	Default
1659:0	DRV RxPDO-Map Negative torque limit value Ch.2	PDO Mapping RxPDO 90	UINT8	RO	0x01 (1 _{dec})
1659:01	SubIndex 001	1. PDO Mapping entry (object 0x7110 (DRV Outputs Ch.2), entry 0x11 (Negative torque limit value))	UINT32	RO	0x7110:11, 16

Index 165A DRV RxPDO-Map Modes of operation Ch.2

Index (hex)	Name	Meaning	Data type	Flags	Default
165A:0	DRV RxPDO-Map Modes of operation Ch.2	PDO Mapping RxPDO 91	UINT8	RO	0x01 (1 _{dec})
165A:01	SubIndex 001	1. PDO Mapping entry (object 0x7110 (DRV Outputs Ch.2), entry 0x03 (Modes of operation))	UINT32	RO	0x7110:03, 8

Index 165B DRV RxPDO-Map Low velocity limit value Ch.2

Index (hex)	Name	Meaning	Data type	Flags	Default
B165:0	DRV RxPDO-Map Low velocity limit value Ch.2	PDO Mapping RxPDO 92	UINT8	RO	0x01 (1 _{dec})
165B:01	SubIndex 001	1. PDO Mapping entry (object 0x7110 (DRV Outputs Ch.2), entry 0x12 (Low velocity limit value))	UINT32	RO	0x7110:12, 32

Index 165C DRV RxPDO-Map High velocity limit value Ch.2

Index (hex)	Name	Meaning	Data type	Flags	Default
165C:0	DRV RxPDO-Map High velocity limit value Ch.2	PDO Mapping RxPDO 93	UINT8	RO	0x01 (1 _{dec})
165C:01	SubIndex 001	1. PDO Mapping entry (object 0x7110 (DRV Outputs Ch.2), entry 0x13 (High velocity limit value))	UINT32	RO	0x7110:13, 32

Index 1660 DMC RxPDO-Map Outputs Ch.2

Index (hex)	Name	Meaning	Data type	Flags	Default
1660:0	DMC RxPDO-Map Outputs Ch.2	PDO Mapping RxPDO 97	UINT8	RO	0x12 (18 _{dec})
1660:01	SubIndex 001	1. PDO Mapping entry (1 bits align)	UINT32	RO	0x0000:00, 1
1660:02	SubIndex 002	2. PDO Mapping entry (object 0x7120 (DMC Outputs Ch.2), entry 0x02 (DMC__FeedbackControl__Enable latch extern on positive edge))	UINT32	RO	0x7120:02, 1
1660:03	SubIndex 003	3. PDO Mapping entry (object 0x7120 (DMC Outputs Ch.2), entry 0x03 (DMC__FeedbackControl__Set counter))	UINT32	RO	0x7120:03, 1
1660:04	SubIndex 004	4. PDO Mapping entry (object 0x7120 (DMC Outputs Ch.2), entry 0x04 (DMC__FeedbackControl__Enable latch extern on negative edge))	UINT32	RO	0x7120:04, 1
1660:05	SubIndex 005	5. PDO Mapping entry (12 bits align)	UINT32	RO	0x0000:00, 12
1660:06	SubIndex 006	6. PDO Mapping entry (object 0x7120 (DMC Outputs Ch.2), entry 0x11 (DMC__DriveControl__Enable))	UINT32	RO	0x7120:11, 1
1660:07	SubIndex 007	7. PDO Mapping entry (object 0x7120 (DMC Outputs Ch.2), entry 0x12 (DMC__DriveControl__Reset))	UINT32	RO	0x7120:12, 1
1660:08	SubIndex 008	8. PDO Mapping entry (14 bits align)	UINT32	RO	0x0000:00, 14
1660:09	SubIndex 009	9. PDO Mapping entry (object 0x7120 (DMC Outputs Ch.2), entry 0x21 (DMC__PositioningControl__Execute))	UINT32	RO	0x7120:21, 1
1660:0A	SubIndex 010	10. PDO Mapping entry (object 0x7120 (DMC Outputs Ch.2), entry 0x22 (DMC__PositioningControl__Emergency stop))	UINT32	RO	0x7120:22, 1
1660:0B	SubIndex 011	11. PDO Mapping entry (14 bits align)	UINT32	RO	0x0000:00, 14
1660:0C	SubIndex 012	12. PDO Mapping entry (object 0x7120 (DMC Outputs Ch.2), entry 0x31 (DMC__Set counter value))	UINT32	RO	0x7120:31, 64
1660:0D	SubIndex 013	13. PDO Mapping entry (object 0x7120 (DMC Outputs Ch.2), entry 0x32 (DMC__Target position))	UINT32	RO	0x7120:32, 64
1660:0E	SubIndex 014	14. PDO Mapping entry (object 0x7120 (DMC Outputs Ch.2), entry 0x33 (DMC__Target velocity))	UINT32	RO	0x7120:33, 16
1660:0F	SubIndex 015	15. PDO Mapping entry (object 0x7120 (DMC Outputs Ch.2), entry 0x34 (DMC__Start type))	UINT32	RO	0x7120:34, 16
1660:10	SubIndex 016	16. PDO Mapping entry (object 0x7120 (DMC Outputs Ch.2), entry 0x35 (DMC__Target acceleration))	UINT32	RO	0x7120:35, 16
1660:11	SubIndex 017	17. PDO Mapping entry (object 0x7120 (DMC Outputs Ch.2), entry 0x36 (DMC__Target deceleration))	UINT32	RO	0x7120:36, 16
1660:12	SubIndex 018	18. PDO Mapping entry (80 bits align)	UINT32	RO	0x0000:00, 80

Index 1661 DMC RxPDO-Map Outputs 32 Bit Ch.2

Index (hex)	Name	Meaning	Data type	Flags	Default
1661:0	DMC RxPDO-Map Outputs 32 Bit Ch.2	PDO Mapping RxPDO 98	UINT8	RO	0x14 (20 _{dec})
1661:01	SubIndex 001	1. PDO Mapping entry (1 bits align)	UINT32	RO	0x0000:00, 1
1661:02	SubIndex 002	2. PDO Mapping entry (object 0x7120 (DMC Outputs Ch.2), entry 0x02 (DMC__FeedbackControl__Enable latch extern on positive edge))	UINT32	RO	0x7120:02, 1
1661:03	SubIndex 003	3. PDO Mapping entry (object 0x7120 (DMC Outputs Ch.2), entry 0x03 (DMC__FeedbackControl__Set counter))	UINT32	RO	0x7120:03, 1
1661:04	SubIndex 004	4. PDO Mapping entry (object 0x7120 (DMC Outputs Ch.2), entry 0x04 (DMC__FeedbackControl__Enable latch extern on negative edge))	UINT32	RO	0x7120:04, 1
1661:05	SubIndex 005	5. PDO Mapping entry (12 bits align)	UINT32	RO	0x0000:00, 12
1661:06	SubIndex 006	6. PDO Mapping entry (object 0x7120 (DMC Outputs Ch.2), entry 0x11 (DMC__DriveControl__Enable))	UINT32	RO	0x7120:11, 1
1661:07	SubIndex 007	7. PDO Mapping entry (object 0x7120 (DMC Outputs Ch.2), entry 0x12 (DMC__DriveControl__Reset))	UINT32	RO	0x7120:12, 1
1661:08	SubIndex 008	8. PDO Mapping entry (14 bits align)	UINT32	RO	0x0000:00, 14
1661:09	SubIndex 009	9. PDO Mapping entry (object 0x7120 (DMC Outputs Ch.2), entry 0x21 (DMC__PositioningControl__Execute))	UINT32	RO	0x7120:21, 1
1661:0A	SubIndex 010	10. PDO Mapping entry (object 0x7120 (DMC Outputs Ch.2), entry 0x22 (DMC__PositioningControl__Emergency stop))	UINT32	RO	0x7120:22, 1
1661:0B	SubIndex 011	11. PDO Mapping entry (14 bits align)	UINT32	RO	0x0000:00, 14
1661:0C	SubIndex 012	12. PDO Mapping entry (object 0x7120 (DMC Outputs Ch.2), entry 0x31 (DMC__Set counter value))	UINT32	RO	0x7120:31, 32
1661:0D	SubIndex 013	13. PDO Mapping entry (32 bits align)	UINT32	RO	0x0000:00, 32
1661:0E	SubIndex 014	14. PDO Mapping entry (object 0x7120 (DMC Outputs Ch.2), entry 0x32 (DMC__Target position))	UINT32	RO	0x7120:32, 32
1661:0F	SubIndex 015	15. PDO Mapping entry (32 bits align)	UINT32	RO	0x0000:00, 32
1661:10	SubIndex 016	16. PDO Mapping entry (object 0x7120 (DMC Outputs Ch.2), entry 0x33 (DMC__Target velocity))	UINT32	RO	0x7120:33, 16
1661:11	SubIndex 017	17. PDO Mapping entry (object 0x7120 (DMC Outputs Ch.2), entry 0x34 (DMC__Start type))	UINT32	RO	0x7120:34, 16
1661:12	SubIndex 018	18. PDO Mapping entry (object 0x7120 (DMC Outputs Ch.2), entry 0x35 (DMC__Target acceleration))	UINT32	RO	0x7120:35, 16
1661:13	SubIndex 019	19. PDO Mapping entry (object 0x7120 (DMC Outputs Ch.2), entry 0x36 (DMC__Target deceleration))	UINT32	RO	0x7120:36, 16
1661:14	SubIndex 020	20. PDO Mapping entry (80 bits align)	UINT32	RO	0x0000:00, 80

Index 1820 DMC TxPDO-Par Inputs Ch.1

Index (hex)	Name	Meaning	Data type	Flags	Default
1820:0	DMC TxPDO-Par Inputs Ch.1	PDO parameter TxPDO 33	UINT8	RO	0x06 (6 _{dec})
1820:06	Exclude TxPDOs	Specifies the TxPDOs (index of TxPDO mapping objects) that must not be transferred together with TxPDO 33	OCTET-STRING[2]	RO	21 1A

Index 1821 DMC TxPDO-Par Inputs 32 Bit Ch.1

Index (hex)	Name	Meaning	Data type	Flags	Default
1821:0	DMC TxPDO-Par Inputs 32 Bit Ch.1	PDO parameter TxPDO 34	UINT8	RO	0x06 (6 _{dec})
1821:06	Exclude TxPDOs	Specifies the TxPDOs (index of TxPDO mapping objects) that must not be transferred together with TxPDO 34	OCTET-STRING[2]	RO	20 1A

Index 1860 DMC TxPDO-Par Inputs Ch.2

Index (hex)	Name	Meaning	Data type	Flags	Default
1860:0	DMC TxPDO-Par Inputs Ch.2	PDO parameter TxPDO 97	UINT8	RO	0x06 (6 _{dec})
1860:06	Exclude TxPDOs	Specifies the TxPDOs (index of TxPDO mapping objects) that must not be transferred together with TxPDO 97	OCTET-STRING[2]	RO	61 1A

Index 1861 DMC TxPDO-Par Inputs 32 Bit Ch.2

Index (hex)	Name	Meaning	Data type	Flags	Default
1861:0	DMC TxPDO-Par Inputs 32 Bit Ch.2	PDO parameter TxPDO 98	UINT8	RO	0x06 (6 _{dec})
1861:06	Exclude TxPDOs	Specifies the TxPDOs (index of TxPDO mapping objects) that must not be transferred together with TxPDO 98	OCTET-STRING[2]	RO	60 1A

Index 1A00 FB TxPDO-Map Position Ch.1

Index (hex)	Name	Meaning	Data type	Flags	Default
1A00:0	FB TxPDO-Map Position Ch.1	PDO Mapping TxPDO 1	UINT8	RO	0x01 (1 _{dec})
1A00:01	SubIndex 001	1. PDO Mapping entry (object 0x6000 (FB Inputs Ch.1), entry 0x11 (Position))	UINT32	RO	0x6000:11, 32

Index 1A02 FB TxPDO-Map Status Ch.1

Index (hex)	Name	Meaning	Data type	Flags	Default
1A02:0	FB TxPDO-Map Status Ch.1	PDO Mapping TxPDO 3	UINT8	RO	0x03 (3 _{dec})
1A02:01	SubIndex 001	1. PDO Mapping entry (13 bits align)	UINT32	RO	0x0000:00, 13
1A02:02	SubIndex 002	2. PDO Mapping entry (object 0x6000 (FB Inputs Ch.1), entry 0x0E (TxPDO State))	UINT32	RO	0x6000:0E, 1
1A02:03	SubIndex 003	3. PDO Mapping entry (object 0x6000 (FB Inputs Ch.1), entry 0x0F (Input cycle counter))	UINT32	RO	0x6000:0F, 2

Index 1A03 FB TxPDO-Map Touch probe status Ch.1

Index (hex)	Name	Meaning	Data type	Flags	Default
1A03:0	FB TxPDO-Map Touch probe status Ch.1	PDO Mapping TxPDO 4	UINT8	RO	0x0A (10 _{dec})
1A03:01	SubIndex 001	1. PDO Mapping entry (object 0x6001 (FB Touch probe inputs Ch.1), entry 0x01 (TP1 Enable))	UINT32	RO	0x6001:01, 1
1A03:02	SubIndex 002	2. PDO Mapping entry (object 0x6001 (FB Touch probe inputs Ch.1), entry 0x02 (TP1 Pos value stored))	UINT32	RO	0x6001:02, 1
1A03:03	SubIndex 003	3. PDO Mapping entry (object 0x6001 (FB Touch probe inputs Ch.1), entry 0x03 (TP1 Neg value stored))	UINT32	RO	0x6001:03, 1
1A03:04	SubIndex 004	4. PDO Mapping entry (4 bits align)	UINT32	RO	0x0000:00, 4
1A03:05	SubIndex 005	5. PDO Mapping entry (object 0x6001 (FB Touch probe inputs Ch.1), entry 0x08 (TP2 Input))	UINT32	RO	0x6001:08, 1
1A03:06	SubIndex 006	6. PDO Mapping entry (object 0x6001 (FB Touch probe inputs Ch.1), entry 0x09 (TP2 Enable))	UINT32	RO	0x6001:09, 1
1A03:07	SubIndex 007	7. PDO Mapping entry (object 0x6001 (FB Touch probe inputs Ch.1), entry 0x0A (TP2 Pos value stored))	UINT32	RO	0x6001:0A, 1
1A03:08	SubIndex 008	8. PDO Mapping entry (object 0x6001 (FB Touch probe inputs Ch.1), entry 0x0B (TP2 Neg value stored))	UINT32	RO	0x6001:0B, 1
1A03:09	SubIndex 009	9. PDO Mapping entry (4 bits align)	UINT32	RO	0x0000:00, 4
1A03:0A	SubIndex 010	10. PDO Mapping entry (object 0x6001 (FB Touch probe inputs Ch.1), entry 0x10 (TP2 Input))	UINT32	RO	0x6001:10, 1

Index 1A04 FB TxPDO-Map Touch probe 1 pos position Ch.1

Index (hex)	Name	Meaning	Data type	Flags	Default
1A04:0	FB TxPDO-Map Touch probe 1 pos position Ch.1	PDO Mapping TxPDO 5	UINT8	RO	0x01 (1 _{dec})
1A04:01	SubIndex 001	1. PDO Mapping entry (object 0x6001 (FB Touch probe inputs Ch.1), entry 0x11 (TP1 Pos position))	UINT32	RO	0x6001:11, 32

Index 1A05 FB TxPDO-Map Touch probe 1 neg position Ch.1

Index (hex)	Name	Meaning	Data type	Flags	Default
1A05:0	FB TxPDO-Map Touch probe 1 neg position Ch.1	PDO Mapping TxPDO 6	UINT8	RO	0x01 (1 _{dec})
1A05:01	SubIndex 001	1. PDO Mapping entry (object 0x6001 (FB Touch probe inputs Ch.1), entry 0x12 (TP1 Neg position))	UINT32	RO	0x6001:12, 32

Index 1A06 FB TxPDO-Map Touch probe 2 pos position Ch.1

Index (hex)	Name	Meaning	Data type	Flags	Default
1A06:0	FB TxPDO-Map Touch probe 2 pos position Ch.1	PDO Mapping TxPDO 7	UINT8	RO	0x01 (1 _{dec})
1A06:01	SubIndex 001	1. PDO Mapping entry (object 0x6001 (FB Touch probe inputs Ch.1), entry 0x13 (TP2 Pos position))	UINT32	RO	0x6001:13, 32

Index 1A07 FB TxPDO-Map Touch probe 2 neg position Ch.1

Index (hex)	Name	Meaning	Data type	Flags	Default
1A07:0	FB TxPDO-Map Touch probe 2 neg position Ch.1	PDO Mapping TxPDO 8	UINT8	RO	0x01 (1 _{dec})
1A07:01	SubIndex 001	1. PDO Mapping entry (object 0x6001 (FB Touch probe inputs Ch.1), entry 0x14 (TP2 Neg position))	UINT32	RO	0x6001:14, 32

Index 1A08 FB TxPDO-Map Touch probe 1 pos timestamp Ch.1

Index (hex)	Name	Meaning	Data type	Flags	Default
1A08:0	FB TxPDO-Map Touch probe 1 pos timestamp Ch.1	PDO Mapping TxPDO 9	UINT8	RO	0x01 (1 _{dec})
1A08:01	SubIndex 001	1. PDO Mapping entry (object 0x6001 (FB Touch probe inputs Ch.1), entry 0x15 (TP1 Pos timestamp))	UINT32	RO	0x6001:15, 32

Index 1A09 FB TxPDO-Map Touch probe 1 neg timestamp Ch.1

Index (hex)	Name	Meaning	Data type	Flags	Default
1A09:0	FB TxPDO-Map Touch probe 1 neg timestamp Ch.1	PDO Mapping TxPDO 10	UINT8	RO	0x01 (1 _{dec})
1A09:01	SubIndex 001	1. PDO Mapping entry (object 0x6001 (FB Touch probe inputs Ch.1), entry 0x16 (TP1 Neg timestamp))	UINT32	RO	0x6001:16, 32

Index 1A0A FB TxPDO-Map Touch probe 2 pos timestamp Ch.1

Index (hex)	Name	Meaning	Data type	Flags	Default
1A0A:0	FB TxPDO-Map Touch probe 2 pos timestamp Ch.1	PDO Mapping TxPDO 11	UINT8	RO	0x01 (1 _{dec})
1A0A:01	SubIndex 001	1. PDO Mapping entry (object 0x6001 (FB Touch probe inputs Ch.1), entry 0x17 (TP2 Pos timestamp))	UINT32	RO	0x6001:17, 32

Index 1A0B FB TxPDO-Map Touch probe 2 neg timestamp Ch.1

Index (hex)	Name	Meaning	Data type	Flags	Default
1A0B:0	FB TxPDO-Map Touch probe 2 neg timestamp Ch.1	PDO Mapping TxPDO 12	UINT8	RO	0x01 (1 _{dec})
1A0B:01	SubIndex 001	1. PDO Mapping entry (object 0x6001 (FB Touch probe inputs Ch.1), entry 0x18 (TP2 Neg timestamp))	UINT32	RO	0x6001:18, 32

Index 1A10 DRV TxPDO-Map Statusword Ch.1

Index (hex)	Name	Meaning	Data type	Flags	Default
1A10:0	DRV TxPDO-Map Statusword Ch.1	PDO Mapping TxPDO 17	UINT8	RO	0x01 (1 _{dec})
1A10:01	SubIndex 001	1. PDO Mapping entry (object 0x6010 (DRV Inputs Ch.1), entry 0x01 (Statusword))	UINT32	RO	0x6010:01, 16

Index 1A11 DRV TxPDO-Map Following error actual value Ch.1

Index (hex)	Name	Meaning	Data type	Flags	Default
1A11:0	DRV TxPDO-Map Following error actual value Ch.1	PDO Mapping TxPDO 18	UINT8	RO	0x01 (1 _{dec})
1A11:01	SubIndex 001	1. PDO Mapping entry (object 0x6010 (DRV Inputs Ch.1), entry 0x06 (Following error actual value))	UINT32	RO	0x6010:06, 32

Index 1A12 DRV TxPDO-Map Velocity actual value Ch.1

Index (hex)	Name	Meaning	Data type	Flags	Default
1A12:0	DRV TxPDO-Map Velocity actual value Ch.1	PDO Mapping TxPDO 19	UINT8	RO	0x01 (1 _{dec})
1A12:01	SubIndex 001	1. PDO Mapping entry (object 0x6010 (DRV Inputs Ch.1), entry 0x07 (Velocity actual value))	UINT32	RO	0x6010:07, 32

Index 1A13 DRV TxPDO-Map Torque actual value Ch.1

Index (hex)	Name	Meaning	Data type	Flags	Default
1A13:0	DRV TxPDO-Map Torque actual value Ch.1	PDO Mapping TxPDO 20	UINT8	RO	0x01 (1 _{dec})
1A13:01	SubIndex 001	1. PDO Mapping entry (object 0x6010 (DRV Inputs Ch.1), entry 0x08 (Torque actual value))	UINT32	RO	0x6010:08, 16

Index 1A14 DRV TxPDO-Map Info data 1 Ch.1

Index (hex)	Name	Meaning	Data type	Flags	Default
1A14:0	DRV TxPDO-Map Info data 1 Ch.1	PDO Mapping TxPDO 21	UINT8	RW	0x01 (1 _{dec})
1A14:01	SubIndex 001	1. PDO Mapping entry (object 0x6010 (DRV Inputs Ch.1), entry 0x12 (Info data 1))	UINT32	RW	0x6010:12, 16
1A14:02	SubIndex 002	2. PDO Mapping entry (0 bits align)	UINT32	RW	0x0000:00, 0
1A14:03	SubIndex 003	3. PDO Mapping entry (0 bits align)	UINT32	RW	0x0000:00, 0
1A14:04	SubIndex 004	4. PDO Mapping entry (0 bits align)	UINT32	RW	0x0000:00, 0
1A14:05	SubIndex 005	5. PDO Mapping entry (0 bits align)	UINT32	RW	0x0000:00, 0
1A14:06	SubIndex 006	6. PDO Mapping entry (0 bits align)	UINT32	RW	0x0000:00, 0
1A14:07	SubIndex 007	7. PDO Mapping entry (0 bits align)	UINT32	RW	0x0000:00, 0
1A14:08	SubIndex 008	8. PDO Mapping entry (0 bits align)	UINT32	RW	0x0000:00, 0
1A14:09	SubIndex 009	9. PDO Mapping entry (0 bits align)	UINT32	RW	0x0000:00, 0
1A14:0A	SubIndex 010	10. PDO Mapping entry (0 bits align)	UINT32	RW	0x0000:00, 0
1A14:0B	SubIndex 011	11. PDO Mapping entry (0 bits align)	UINT32	RW	0x0000:00, 0
1A14:0C	SubIndex 012	12. PDO Mapping entry (0 bits align)	UINT32	RW	0x0000:00, 0
1A14:0D	SubIndex 013	13. PDO Mapping entry (0 bits align)	UINT32	RW	0x0000:00, 0
1A14:0E	SubIndex 014	14. PDO Mapping entry (0 bits align)	UINT32	RW	0x0000:00, 0
1A14:0F	SubIndex 015	15. PDO Mapping entry (0 bits align)	UINT32	RW	0x0000:00, 0
1A14:10	SubIndex 016	16. PDO Mapping entry (0 bits align)	UINT32	RW	0x0000:00, 0

Index 1A15 DRV TxPDO-Map Info data 2 Ch.1

Index (hex)	Name	Meaning	Data type	Flags	Default
1A15:0	DRV TxPDO-Map Info data 2 Ch.1	PDO Mapping TxPDO 22	UINT8	RW	0x01 (1 _{dec})
1A15:01	SubIndex 001	1. PDO Mapping entry (object 0x6010 (DRV Inputs Ch.1), entry 0x13 (Info data 2))	UINT32	RW	0x6010:13, 16
1A15:02	SubIndex 002	2. PDO Mapping entry (0 bits align)	UINT32	RW	0x0000:00, 0
1A15:03	SubIndex 003	3. PDO Mapping entry (0 bits align)	UINT32	RW	0x0000:00, 0
1A15:04	SubIndex 004	4. PDO Mapping entry (0 bits align)	UINT32	RW	0x0000:00, 0
1A15:05	SubIndex 005	5. PDO Mapping entry (0 bits align)	UINT32	RW	0x0000:00, 0
1A15:06	SubIndex 006	6. PDO Mapping entry (0 bits align)	UINT32	RW	0x0000:00, 0
1A15:07	SubIndex 007	7. PDO Mapping entry (0 bits align)	UINT32	RW	0x0000:00, 0
1A15:08	SubIndex 008	8. PDO Mapping entry (0 bits align)	UINT32	RW	0x0000:00, 0
1A15:09	SubIndex 009	9. PDO Mapping entry (0 bits align)	UINT32	RW	0x0000:00, 0
1A15:0A	SubIndex 010	10. PDO Mapping entry (0 bits align)	UINT32	RW	0x0000:00, 0
1A15:0B	SubIndex 011	11. PDO Mapping entry (0 bits align)	UINT32	RW	0x0000:00, 0
1A15:0C	SubIndex 012	12. PDO Mapping entry (0 bits align)	UINT32	RW	0x0000:00, 0
1A15:0D	SubIndex 013	13. PDO Mapping entry (0 bits align)	UINT32	RW	0x0000:00, 0
1A15:0E	SubIndex 014	14. PDO Mapping entry (0 bits align)	UINT32	RW	0x0000:00, 0
1A15:0F	SubIndex 015	15. PDO Mapping entry (0 bits align)	UINT32	RW	0x0000:00, 0
1A15:10	SubIndex 016	16. PDO Mapping entry (0 bits align)	UINT32	RW	0x0000:00, 0

Index 1A16 DRV TxPDO-Map Info data 3 Ch.1

Index (hex)	Name	Meaning	Data type	Flags	Default
1A16:0	DRV TxPDO-Map Info data 3 Ch.1	PDO Mapping TxPDO 23	UINT8	RW	0x01 (1 _{dec})
1A16:01	SubIndex 001	1. PDO Mapping entry (object 0x6010 (DRV Inputs Ch.1), entry 0x14 (Info data 3))	UINT32	RW	0x6010:14, 16
1A16:02	SubIndex 002	2. PDO Mapping entry (0 bits align)	UINT32	RW	0x0000:00, 0
1A16:03	SubIndex 003	3. PDO Mapping entry (0 bits align)	UINT32	RW	0x0000:00, 0
1A16:04	SubIndex 004	4. PDO Mapping entry (0 bits align)	UINT32	RW	0x0000:00, 0
1A16:05	SubIndex 005	5. PDO Mapping entry (0 bits align)	UINT32	RW	0x0000:00, 0
1A16:06	SubIndex 006	6. PDO Mapping entry (0 bits align)	UINT32	RW	0x0000:00, 0
1A16:07	SubIndex 007	7. PDO Mapping entry (0 bits align)	UINT32	RW	0x0000:00, 0
1A16:08	SubIndex 008	8. PDO Mapping entry (0 bits align)	UINT32	RW	0x0000:00, 0
1A16:09	SubIndex 009	9. PDO Mapping entry (0 bits align)	UINT32	RW	0x0000:00, 0
1A16:0A	SubIndex 010	10. PDO Mapping entry (0 bits align)	UINT32	RW	0x0000:00, 0
1A16:0B	SubIndex 011	11. PDO Mapping entry (0 bits align)	UINT32	RW	0x0000:00, 0
1A16:0C	SubIndex 012	12. PDO Mapping entry (0 bits align)	UINT32	RW	0x0000:00, 0
1A16:0D	SubIndex 013	13. PDO Mapping entry (0 bits align)	UINT32	RW	0x0000:00, 0
1A16:0E	SubIndex 014	14. PDO Mapping entry (0 bits align)	UINT32	RW	0x0000:00, 0
1A16:0F	SubIndex 015	15. PDO Mapping entry (0 bits align)	UINT32	RW	0x0000:00, 0
1A16:10	SubIndex 016	16. PDO Mapping entry (0 bits align)	UINT32	RW	0x0000:00, 0

Index 1A17 DRV TxPDO-Map Modes of operation display Ch.1

Index (hex)	Name	Meaning	Data type	Flags	Default
1A17:0	DRV TxPDO-Map Modes of operation display Ch.1	PDO Mapping TxPDO 24	UINT8	RO	0x01 (1 _{dec})
1A17:01	SubIndex 001	1. PDO Mapping entry (object 0x6010 (DRV Inputs Ch.1), entry 0x03 (Modes of operation display))	UINT32	RO	0x6010:03, 8

Index 1A18 DRV TxPDO-Map Torque limitation status Ch.1

Index (hex)	Name	Meaning	Data type	Flags	Default
1A18:0	DRV TxPDO-Map Torque limitation status Ch.1	PDO Mapping TxPDO 25	UINT8	RO	0x01 (1 _{dec})
1A18:01	SubIndex 001	1. PDO Mapping entry (object 0x6010 (DRV Inputs Ch.1), entry 0x15 (Torque limitation status))	UINT32	RO	0x6010:15, 8

Index 1A20 DMC TxPDO-Map Inputs Ch.1

Index (hex)	Name	Meaning	Data type	Flags	Default
1A20:0	DMC TxPDO-Map Inputs Ch.1	PDO Mapping TxPDO 33	UINT8	RO	0x26 (38 _{dec})
1A20:01	SubIndex 001	1. PDO Mapping entry (1 bits align)	UINT32	RO	0x0000:00, 1
1A20:02	SubIndex 002	2. PDO Mapping entry (object 0x6020 (DMC Inputs Ch.1), entry 0x02 (DMC__FeedbackStatus__Latch extern valid))	UINT32	RO	0x6020:02, 1
1A20:03	SubIndex 003	3. PDO Mapping entry (object 0x6020 (DMC Inputs Ch.1), entry 0x03 (DMC__FeedbackStatus__Set counter done))	UINT32	RO	0x6020:03, 1
1A20:04	SubIndex 004	4. PDO Mapping entry (9 bits align)	UINT32	RO	0x0000:00, 9
1A20:05	SubIndex 005	5. PDO Mapping entry (object 0x6020 (DMC Inputs Ch.1), entry 0x0D (DMC__FeedbackStatus__Status of extern latch))	UINT32	RO	0x6020:0D, 1
1A20:06	SubIndex 006	6. PDO Mapping entry (3 bits align)	UINT32	RO	0x0000:00, 3
1A20:07	SubIndex 007	7. PDO Mapping entry (object 0x6020 (DMC Inputs Ch.1), entry 0x11 (DMC__DriveStatus__Ready to enable))	UINT32	RO	0x6020:11, 1
1A20:08	SubIndex 008	8. PDO Mapping entry (object 0x6020 (DMC Inputs Ch.1), entry 0x12 (DMC__DriveStatus__Ready))	UINT32	RO	0x6020:12, 1
1A20:09	SubIndex 009	9. PDO Mapping entry (object 0x6020 (DMC Inputs Ch.1), entry 0x13 (DMC__DriveStatus__Warning))	UINT32	RO	0x6020:13, 1
1A20:0A	SubIndex 010	10. PDO Mapping entry (object 0x6020 (DMC Inputs Ch.1), entry 0x14 (DMC__DriveStatus__Error))	UINT32	RO	0x6020:14, 1
1A20:0B	SubIndex 011	11. PDO Mapping entry (object 0x6020 (DMC Inputs Ch.1), entry 0x15 (DMC__DriveStatus__Moving positive))	UINT32	RO	0x6020:15, 1
1A20:0C	SubIndex 012	12. PDO Mapping entry (object 0x6020 (DMC Inputs Ch.1), entry 0x16 (DMC__DriveStatus__Moving negative))	UINT32	RO	0x6020:16, 1
1A20:0D	SubIndex 013	13. PDO Mapping entry (5 bits align)	UINT32	RO	0x0000:00, 5
1A20:0E	SubIndex 014	14. PDO Mapping entry (object 0x6020 (DMC Inputs Ch.1), entry 0x1C (DMC__DriveStatus__Digital input 1))	UINT32	RO	0x6020:1C, 1
1A20:0F	SubIndex 015	15. PDO Mapping entry (object 0x6020 (DMC Inputs Ch.1), entry 0x1D (DMC__DriveStatus__Digital input 2))	UINT32	RO	0x6020:1D, 1
1A20:10	SubIndex 016	16. PDO Mapping entry (3 bits align)	UINT32	RO	0x0000:00, 3
1A20:11	SubIndex 017	17. PDO Mapping entry (object 0x6020 (DMC Inputs Ch.1), entry 0x21 (DMC__PositioningStatus__Busy))	UINT32	RO	0x6020:21, 1
1A20:12	SubIndex 018	18. PDO Mapping entry (object 0x6020 (DMC Inputs Ch.1), entry 0x22 (DMC__PositioningStatus__In-Target))	UINT32	RO	0x6020:22, 1
1A20:13	SubIndex 019	19. PDO Mapping entry (object 0x6020 (DMC Inputs Ch.1), entry 0x23 (DMC__PositioningStatus__Warning))	UINT32	RO	0x6020:23, 1
1A20:14	SubIndex 020	20. PDO Mapping entry (object 0x6020 (DMC Inputs Ch.1), entry 0x24 (DMC__PositioningStatus__Error))	UINT32	RO	0x6020:24, 1
1A20:15	SubIndex 021	21. PDO Mapping entry (object 0x6020 (DMC Inputs Ch.1), entry 0x25 (DMC__PositioningStatus__Calibrated))	UINT32	RO	0x6020:25, 1
1A20:16	SubIndex 022	22. PDO Mapping entry (object 0x6020 (DMC Inputs Ch.1), entry 0x26 (DMC__PositioningStatus__Accelerate))	UINT32	RO	0x6020:26, 1
1A20:17	SubIndex 023	23. PDO Mapping entry (object 0x6020 (DMC Inputs Ch.1), entry 0x27 (DMC__PositioningStatus__Decelerate))	UINT32	RO	0x6020:27, 1
1A20:18	SubIndex 024	24. PDO Mapping entry (object 0x6020 (DMC Inputs Ch.1), entry 0x28 (DMC__PositioningStatus__Ready to execute))	UINT32	RO	0x6020:28, 1
1A20:19	SubIndex 025	25. PDO Mapping entry (8 bits align)	UINT32	RO	0x0000:00, 8
1A20:1A	SubIndex 026	26. PDO Mapping entry (object 0x6020 (DMC Inputs Ch.1), entry 0x31 (DMC__Set position))	UINT32	RO	0x6020:31, 64

1A20:1B	SubIndex 027	27. PDO Mapping entry (object 0x6020 (DMC Inputs Ch.1), entry 0x32 (DMC__Set velocity))	UINT32	RO	0x6020:32, 16
1A20:1C	SubIndex 028	28. PDO Mapping entry (object 0x6020 (DMC Inputs Ch.1), entry 0x33 (DMC__Actual drive time))	UINT32	RO	0x6020:33, 32
1A20:1D	SubIndex 029	29. PDO Mapping entry (object 0x6020 (DMC Inputs Ch.1), entry 0x34 (DMC__Actual position lag))	UINT32	RO	0x6020:34, 64
1A20:1E	SubIndex 030	30. PDO Mapping entry (object 0x6020 (DMC Inputs Ch.1), entry 0x35 (DMC__Actual velocity))	UINT32	RO	0x6020:35, 16
1A20:1F	SubIndex 031	31. PDO Mapping entry (object 0x6020 (DMC Inputs Ch.1), entry 0x36 (DMC__Actual position))	UINT32	RO	0x6020:36, 64
1A20:20	SubIndex 032	32. PDO Mapping entry (object 0x6020 (DMC Inputs Ch.1), entry 0x37 (DMC__Error id))	UINT32	RO	0x6020:37, 32
1A20:21	SubIndex 033	33. PDO Mapping entry (object 0x6020 (DMC Inputs Ch.1), entry 0x38 (DMC__Input cycle counter))	UINT32	RO	0x6020:38, 8
1A20:22	SubIndex 034	34. PDO Mapping entry (object 0x6020 (DMC Inputs Ch.1), entry 0x39 (DMC__Channel id))	UINT32	RO	0x6020:39, 8
1A20:23	SubIndex 035	35. PDO Mapping entry (object 0x6020 (DMC Inputs Ch.1), entry 0x3A (DMC__Latch value))	UINT32	RO	0x6020:3A, 64
1A20:24	SubIndex 036	36. PDO Mapping entry (object 0x6020 (DMC Inputs Ch.1), entry 0x3B (DMC__Cyclic info data 1))	UINT32	RO	0x6020:3B, 16
1A20:25	SubIndex 037	37. PDO Mapping entry (object 0x6020 (DMC Inputs Ch.1), entry 0x3C (DMC__Cyclic info data 2))	UINT32	RO	0x6020:3C, 16
1A20:26	SubIndex 038	38. PDO Mapping entry (64 bits align)	UINT32	RO	0x0000:00, 64

Index 1A21 DMC TxPDO-Map Inputs 32 Bit Ch.1

Index (hex)	Name	Meaning	Data type	Flags	Default
1A21:0	DMC TxPDO-Map Inputs 32 Bit Ch.1	PDO Mapping TxPDO 34	UINT8	RO	0x2A (42 _{dec})
1A21:01	SubIndex 001	1. PDO Mapping entry (1 bits align)	UINT32	RO	0x0000:00, 1
1A21:02	SubIndex 002	2. PDO Mapping entry (object 0x6020 (DMC Inputs Ch.1), entry 0x02 (DMC__FeedbackStatus__Latch extern valid))	UINT32	RO	0x6020:02, 1
1A21:03	SubIndex 003	3. PDO Mapping entry (object 0x6020 (DMC Inputs Ch.1), entry 0x03 (DMC__FeedbackStatus__Set counter done))	UINT32	RO	0x6020:03, 1
1A21:04	SubIndex 004	4. PDO Mapping entry (9 bits align)	UINT32	RO	0x0000:00, 9
1A21:05	SubIndex 005	5. PDO Mapping entry (object 0x6020 (DMC Inputs Ch.1), entry 0x0D (DMC__FeedbackStatus__Status of extern latch))	UINT32	RO	0x6020:0D, 1
1A21:06	SubIndex 006	6. PDO Mapping entry (3 bits align)	UINT32	RO	0x0000:00, 3
1A21:07	SubIndex 007	7. PDO Mapping entry (object 0x6020 (DMC Inputs Ch.1), entry 0x11 (DMC__DriveStatus__Ready to enable))	UINT32	RO	0x6020:11, 1
1A21:08	SubIndex 008	8. PDO Mapping entry (object 0x6020 (DMC Inputs Ch.1), entry 0x12 (DMC__DriveStatus__Ready))	UINT32	RO	0x6020:12, 1
1A21:09	SubIndex 009	9. PDO Mapping entry (object 0x6020 (DMC Inputs Ch.1), entry 0x13 (DMC__DriveStatus__Warning))	UINT32	RO	0x6020:13, 1
1A21:0A	SubIndex 010	10. PDO Mapping entry (object 0x6020 (DMC Inputs Ch.1), entry 0x14 (DMC__DriveStatus__Error))	UINT32	RO	0x6020:14, 1
1A21:0B	SubIndex 011	11. PDO Mapping entry (object 0x6020 (DMC Inputs Ch.1), entry 0x15 (DMC__DriveStatus__Moving positive))	UINT32	RO	0x6020:15, 1
1A21:0C	SubIndex 012	12. PDO Mapping entry (object 0x6020 (DMC Inputs Ch.1), entry 0x16 (DMC__DriveStatus__Moving negative))	UINT32	RO	0x6020:16, 1
1A21:0D	SubIndex 013	13. PDO Mapping entry (5 bits align)	UINT32	RO	0x0000:00, 5
1A21:0E	SubIndex 014	14. PDO Mapping entry (object 0x6020 (DMC Inputs Ch.1), entry 0x1C (DMC__DriveStatus__Digital input 1))	UINT32	RO	0x6020:1C, 1
1A21:0F	SubIndex 015	15. PDO Mapping entry (object 0x6020 (DMC Inputs Ch.1), entry 0x1D (DMC__DriveStatus__Digital input 2))	UINT32	RO	0x6020:1D, 1
1A21:10	SubIndex 016	16. PDO Mapping entry (3 bits align)	UINT32	RO	0x0000:00, 3
1A21:11	SubIndex 017	17. PDO Mapping entry (object 0x6020 (DMC Inputs Ch.1), entry 0x21 (DMC__PositioningStatus__Busy))	UINT32	RO	0x6020:21, 1
1A21:12	SubIndex 018	18. PDO Mapping entry (object 0x6020 (DMC Inputs Ch.1), entry 0x22 (DMC__PositioningStatus__In-Target))	UINT32	RO	0x6020:22, 1
1A21:13	SubIndex 019	19. PDO Mapping entry (object 0x6020 (DMC Inputs Ch.1), entry 0x23 (DMC__PositioningStatus__Warning))	UINT32	RO	0x6020:23, 1
1A21:14	SubIndex 020	20. PDO Mapping entry (object 0x6020 (DMC Inputs Ch.1), entry 0x24 (DMC__PositioningStatus__Error))	UINT32	RO	0x6020:24, 1
1A21:15	SubIndex 021	21. PDO Mapping entry (object 0x6020 (DMC Inputs Ch.1), entry 0x25 (DMC__PositioningStatus__Calibrated))	UINT32	RO	0x6020:25, 1
1A21:16	SubIndex 022	22. PDO Mapping entry (object 0x6020 (DMC Inputs Ch.1), entry 0x26 (DMC__PositioningStatus__Accelerate))	UINT32	RO	0x6020:26, 1
1A21:17	SubIndex 023	23. PDO Mapping entry (object 0x6020 (DMC Inputs Ch.1), entry 0x27 (DMC__PositioningStatus__Decelerate))	UINT32	RO	0x6020:27, 1
1A21:18	SubIndex 024	24. PDO Mapping entry (object 0x6020 (DMC Inputs Ch.1), entry 0x28 (DMC__PositioningStatus__Ready to execute))	UINT32	RO	0x6020:28, 1
1A21:19	SubIndex 025	25. PDO Mapping entry (8 bits align)	UINT32	RO	0x0000:00, 8
1A21:1A	SubIndex 026	26. PDO Mapping entry (object 0x6020 (DMC Inputs Ch.1), entry 0x31 (DMC__Set position))	UINT32	RO	0x6020:31, 32

1A21:1B	SubIndex 027	27. PDO Mapping entry (32 bits align)	UINT32	RO	0x0000:00, 32
1A21:1C	SubIndex 028	28. PDO Mapping entry (object 0x6020 (DMC Inputs Ch.1), entry 0x32 (DMC__Set velocity))	UINT32	RO	0x6020:32, 16
1A21:1D	SubIndex 029	29. PDO Mapping entry (object 0x6020 (DMC Inputs Ch.1), entry 0x33 (DMC__Actual drive time))	UINT32	RO	0x6020:33, 32
1A21:1E	SubIndex 030	30. PDO Mapping entry (object 0x6020 (DMC Inputs Ch.1), entry 0x34 (DMC__Actual position lag))	UINT32	RO	0x6020:34, 32
1A21:1F	SubIndex 031	31. PDO Mapping entry (32 bits align)	UINT32	RO	0x0000:00, 32
1A21:20	SubIndex 032	32. PDO Mapping entry (object 0x6020 (DMC Inputs Ch.1), entry 0x35 (DMC__Actual velocity))	UINT32	RO	0x6020:35, 16
1A21:21	SubIndex 033	33. PDO Mapping entry (object 0x6020 (DMC Inputs Ch.1), entry 0x36 (DMC__Actual position))	UINT32	RO	0x6020:36, 32
1A21:22	SubIndex 034	34. PDO Mapping entry (32 bits align)	UINT32	RO	0x0000:00, 32
1A21:23	SubIndex 035	35. PDO Mapping entry (object 0x6020 (DMC Inputs Ch.1), entry 0x37 (DMC__Error id))	UINT32	RO	0x6020:37, 32
1A21:24	SubIndex 036	36. PDO Mapping entry (object 0x6020 (DMC Inputs Ch.1), entry 0x38 (DMC__Input cycle counter))	UINT32	RO	0x6020:38, 8
1A21:25	SubIndex 037	37. PDO Mapping entry (8 bits align)	UINT32	RO	0x0000:00, 8
1A21:26	SubIndex 038	38. PDO Mapping entry (object 0x6020 (DMC Inputs Ch.1), entry 0x3A (DMC__Latch value))	UINT32	RO	0x6020:3A, 32
1A21:27	SubIndex 039	39. PDO Mapping entry (32 bits align)	UINT32	RO	0x0000:00, 32
1A21:28	SubIndex 040	40. PDO Mapping entry (object 0x6020 (DMC Inputs Ch.1), entry 0x3B (DMC__Cyclic info data 1))	UINT32	RO	0x6020:3B, 16
1A21:29	SubIndex 041	41. PDO Mapping entry (object 0x6020 (DMC Inputs Ch.1), entry 0x3C (DMC__Cyclic info data 2))	UINT32	RO	0x6020:3C, 16
1A21:2A	SubIndex 042	42. PDO Mapping entry (64 bits align)	UINT32	RO	0x0000:00, 64

Index 1A40 FB TxPDO-Map Position Ch.2

Index (hex)	Name	Meaning	Data type	Flags	Default
1A40:0	FB TxPDO-Map Position Ch.2	PDO Mapping TxPDO 65	UINT8	RO	0x01 (1 _{dec})
1A40:01	SubIndex 001	1. PDO Mapping entry (object 0x6100 (FB Inputs Ch.2), entry 0x11 (Position))	UINT32	RO	0x6100:11, 32

Index 1A42 FB TxPDO-Map Status Ch.2

Index (hex)	Name	Meaning	Data type	Flags	Default
1A42:0	FB TxPDO-Map Status Ch.2	PDO Mapping TxPDO 67	UINT8	RO	0x03 (3 _{dec})
1A42:01	SubIndex 001	1. PDO Mapping entry (13 bits align)	UINT32	RO	0x0000:00, 13
1A42:02	SubIndex 002	2. PDO Mapping entry (object 0x6100 (FB Inputs Ch.2), entry 0x0E (TxPDO State))	UINT32	RO	0x6100:0E, 1
1A42:03	SubIndex 003	3. PDO Mapping entry (object 0x6100 (FB Inputs Ch.2), entry 0x0F (Input cycle counter))	UINT32	RO	0x6100:0F, 2

Index 1A43 FB TxPDO-Map Touch probe status Ch.2

Index (hex)	Name	Meaning	Data type	Flags	Default
1A43:0	FB TxPDO-Map Touch probe status Ch.2	PDO Mapping TxPDO 68	UINT8	RO	0x0A (10 _{dec})
1A43:01	SubIndex 001	1. PDO Mapping entry (object 0x6101 (FB Touch probe inputs Ch.2), entry 0x01 (TP1 Enable))	UINT32	RO	0x6101:01, 1
1A43:02	SubIndex 002	2. PDO Mapping entry (object 0x6101 (FB Touch probe inputs Ch.2), entry 0x02 (TP1 Pos value stored))	UINT32	RO	0x6101:02, 1
1A43:03	SubIndex 003	3. PDO Mapping entry (object 0x6101 (FB Touch probe inputs Ch.2), entry 0x03 (TP1 Neg value stored))	UINT32	RO	0x6101:03, 1
1A43:04	SubIndex 004	4. PDO Mapping entry (4 bits align)	UINT32	RO	0x0000:00, 4
1A43:05	SubIndex 005	5. PDO Mapping entry (object 0x6101 (FB Touch probe inputs Ch.2), entry 0x08 (TP1 Input))	UINT32	RO	0x6101:08, 1
1A43:06	SubIndex 006	6. PDO Mapping entry (object 0x6101 (FB Touch probe inputs Ch.2), entry 0x09 (TP2 Enable))	UINT32	RO	0x6101:09, 1
1A43:07	SubIndex 007	7. PDO Mapping entry (object 0x6101 (FB Touch probe inputs Ch.2), entry 0x0A (TP2 Pos value stored))	UINT32	RO	0x6101:0A, 1
1A43:08	SubIndex 008	8. PDO Mapping entry (object 0x6101 (FB Touch probe inputs Ch.2), entry 0x0B (TP2 Neg value stored))	UINT32	RO	0x6101:0B, 1
1A43:09	SubIndex 009	9. PDO Mapping entry (4 bits align)	UINT32	RO	0x0000:00, 4
1A43:0A	SubIndex 010	10. PDO Mapping entry (object 0x6101 (FB Touch probe inputs Ch.2), entry 0x10 (TP2 Input))	UINT32	RO	0x6101:10, 1

Index 1A44 FB TxPDO-Map Touch probe 1 pos position Ch.2

Index (hex)	Name	Meaning	Data type	Flags	Default
1A44:0	FB TxPDO-Map Touch probe 1 pos position Ch.2	PDO Mapping TxPDO 69	UINT8	RO	0x01 (1 _{dec})
1A44:01	SubIndex 001	1. PDO Mapping entry (object 0x6101 (FB Touch probe inputs Ch.2), entry 0x11 (TP1 Pos position))	UINT32	RO	0x6101:11, 32

Index 1A45 FB TxPDO-Map Touch probe 1 neg position Ch.2

Index (hex)	Name	Meaning	Data type	Flags	Default
1A45:0	FB TxPDO-Map Touch probe 1 neg position Ch.2	PDO Mapping TxPDO 70	UINT8	RO	0x01 (1 _{dec})
1A45:01	SubIndex 001	1. PDO Mapping entry (object 0x6101 (FB Touch probe inputs Ch.2), entry 0x12 (TP1 Neg position))	UINT32	RO	0x6101:12, 32

Index 1A46 FB TxPDO-Map Touch probe 2 pos position Ch.2

Index (hex)	Name	Meaning	Data type	Flags	Default
1A46:0	FB TxPDO-Map Touch probe 2 pos position Ch.2	PDO Mapping TxPDO 71	UINT8	RO	0x01 (1 _{dec})
1A46:01	SubIndex 001	1. PDO Mapping entry (object 0x6101 (FB Touch probe inputs Ch.2), entry 0x13 (TP2 Pos position))	UINT32	RO	0x6101:13, 32

Index 1A47 FB TxPDO-Map Touch probe 2 neg position Ch.2

Index (hex)	Name	Meaning	Data type	Flags	Default
1A47:0	FB TxPDO-Map Touch probe 2 neg position Ch.2	PDO Mapping TxPDO 72	UINT8	RO	0x01 (1 _{dec})
1A47:01	SubIndex 001	1. PDO Mapping entry (object 0x6101 (FB Touch probe inputs Ch.2), entry 0x14 (TP2 Neg position))	UINT32	RO	0x6101:14, 32

Index 1A48 FB TxPDO-Map Touch probe 1 pos timestamp Ch.2

Index (hex)	Name	Meaning	Data type	Flags	Default
1A48:0	FB TxPDO-Map Touch probe 1 pos timestamp Ch.2	PDO Mapping TxPDO 73	UINT8	RO	0x01 (1 _{dec})
1A48:01	SubIndex 001	1. PDO Mapping entry (object 0x6101 (FB Touch probe inputs Ch.2), entry 0x15 (TP1 Pos timestamp))	UINT32	RO	0x6101:15, 32

Index 1A49 FB TxPDO-Map Touch probe 1 neg timestamp Ch.2

Index (hex)	Name	Meaning	Data type	Flags	Default
1A49:0	FB TxPDO-Map Touch probe 1 neg timestamp Ch.2	PDO Mapping TxPDO 74	UINT8	RO	0x01 (1 _{dec})
1A49:01	SubIndex 001	1. PDO Mapping entry (object 0x6101 (FB Touch probe inputs Ch.2), entry 0x16 (TP1 Neg timestamp))	UINT32	RO	0x6101:16, 32

Index 1A4A FB TxPDO-Map Touch probe 2 pos timestamp Ch.2

Index (hex)	Name	Meaning	Data type	Flags	Default
1A4A:0	FB TxPDO-Map Touch probe 2 pos timestamp Ch.2	PDO Mapping TxPDO 75	UINT8	RO	0x01 (1 _{dec})
1A4A:01	SubIndex 001	1. PDO Mapping entry (object 0x6101 (FB Touch probe inputs Ch.2), entry 0x17 (TP2 Pos timestamp))	UINT32	RO	0x6101:17, 32

Index 1A4B FB TxPDO-Map Touch probe 2 neg timestamp Ch.2

Index (hex)	Name	Meaning	Data type	Flags	Default
1A4B:0	FB TxPDO-Map Touch probe 2 neg timestamp Ch.2	PDO Mapping TxPDO 76	UINT8	RO	0x01 (1 _{dec})
1A4B:01	SubIndex 001	1. PDO Mapping entry (object 0x6101 (FB Touch probe inputs Ch.2), entry 0x18 (TP2 Neg timestamp))	UINT32	RO	0x6101:18, 32

Index 1A50 DRV TxPDO-Map Statusword Ch.2

Index (hex)	Name	Meaning	Data type	Flags	Default
1A50:0	DRV TxPDO-Map Statusword Ch.2	PDO Mapping TxPDO 81	UINT8	RO	0x01 (1 _{dec})
1A50:01	SubIndex 001	1. PDO Mapping entry (object 0x6110 (DRV Inputs Ch.2), entry 0x01 (Statusword))	UINT32	RO	0x6110:01, 16

Index 1A51 DRV TxPDO-Map Following error actual value Ch.2

Index (hex)	Name	Meaning	Data type	Flags	Default
1A51:0	DRV TxPDO-Map Following error actual value Ch.2	PDO Mapping TxPDO 82	UINT8	RO	0x01 (1 _{dec})
1A51:01	SubIndex 001	1. PDO Mapping entry (object 0x6110 (DRV Inputs Ch.2), entry 0x06 (Following error actual value))	UINT32	RO	0x6110:06, 32

Index 1A52 DRV TxPDO-Map Velocity actual value Ch.2

Index (hex)	Name	Meaning	Data type	Flags	Default
1A52:0	DRV TxPDO-Map Velocity actual value Ch.2	PDO Mapping TxPDO 83	UINT8	RO	0x01 (1 _{dec})
1A52:01	SubIndex 001	1. PDO Mapping entry (object 0x6110 (DRV Inputs Ch.2), entry 0x07 (Velocity actual value))	UINT32	RO	0x6110:07, 32

Index 1A53 DRV TxPDO-Map Torque actual value Ch.2

Index (hex)	Name	Meaning	Data type	Flags	Default
1A53:0	DRV TxPDO-Map Torque actual value Ch.2	PDO Mapping TxPDO 84	UINT8	RO	0x01 (1 _{dec})
1A53:01	SubIndex 001	1. PDO Mapping entry (object 0x6110 (DRV Inputs Ch.2), entry 0x08 (Torque actual value))	UINT32	RO	0x6110:08, 16

Index 1A54 DRV TxPDO-Map Info data 1 Ch.2

Index (hex)	Name	Meaning	Data type	Flags	Default
1A54:0	DRV TxPDO-Map Info data 1 Ch.2	PDO Mapping TxPDO 85	UINT8	RW	0x01 (1 _{dec})
1A54:01	SubIndex 001	1. PDO Mapping entry (object 0x6110 (DRV Inputs Ch.2), entry 0x12 (Info data 1))	UINT32	RW	0x6110:12, 16
1A54:02	SubIndex 002	2. PDO Mapping entry (0 bits align)	UINT32	RW	0x0000:00, 0
1A54:03	SubIndex 003	3. PDO Mapping entry (0 bits align)	UINT32	RW	0x0000:00, 0
1A54:04	SubIndex 004	4. PDO Mapping entry (0 bits align)	UINT32	RW	0x0000:00, 0
1A54:05	SubIndex 005	5. PDO Mapping entry (0 bits align)	UINT32	RW	0x0000:00, 0
1A54:06	SubIndex 006	6. PDO Mapping entry (0 bits align)	UINT32	RW	0x0000:00, 0
1A54:07	SubIndex 007	7. PDO Mapping entry (0 bits align)	UINT32	RW	0x0000:00, 0
1A54:08	SubIndex 008	8. PDO Mapping entry (0 bits align)	UINT32	RW	0x0000:00, 0
1A54:09	SubIndex 009	9. PDO Mapping entry (0 bits align)	UINT32	RW	0x0000:00, 0
1A54:0A	SubIndex 010	10. PDO Mapping entry (0 bits align)	UINT32	RW	0x0000:00, 0
1A54:0B	SubIndex 011	11. PDO Mapping entry (0 bits align)	UINT32	RW	0x0000:00, 0
1A54:0C	SubIndex 012	12. PDO Mapping entry (0 bits align)	UINT32	RW	0x0000:00, 0
1A54:0D	SubIndex 013	13. PDO Mapping entry (0 bits align)	UINT32	RW	0x0000:00, 0
1A54:0E	SubIndex 014	14. PDO Mapping entry (0 bits align)	UINT32	RW	0x0000:00, 0
1A54:0F	SubIndex 015	15. PDO Mapping entry (0 bits align)	UINT32	RW	0x0000:00, 0
1A54:10	SubIndex 016	16. PDO Mapping entry (0 bits align)	UINT32	RW	0x0000:00, 0

Index 1A55 DRV TxPDO-Map Info data 2 Ch.2

Index (hex)	Name	Meaning	Data type	Flags	Default
1A55:0	DRV TxPDO-Map Info data 2 Ch.2	PDO Mapping TxPDO 86	UINT8	RW	0x01 (1 _{dec})
1A55:01	SubIndex 001	1. PDO Mapping entry (object 0x6110 (DRV Inputs Ch.2), entry 0x13 (Info data 2))	UINT32	RW	0x6110:13, 16
1A55:02	SubIndex 002	2. PDO Mapping entry (0 bits align)	UINT32	RW	0x0000:00, 0
1A55:03	SubIndex 003	3. PDO Mapping entry (0 bits align)	UINT32	RW	0x0000:00, 0
1A55:04	SubIndex 004	4. PDO Mapping entry (0 bits align)	UINT32	RW	0x0000:00, 0
1A55:05	SubIndex 005	5. PDO Mapping entry (0 bits align)	UINT32	RW	0x0000:00, 0
1A55:06	SubIndex 006	6. PDO Mapping entry (0 bits align)	UINT32	RW	0x0000:00, 0
1A55:07	SubIndex 007	7. PDO Mapping entry (0 bits align)	UINT32	RW	0x0000:00, 0
1A55:08	SubIndex 008	8. PDO Mapping entry (0 bits align)	UINT32	RW	0x0000:00, 0
1A55:09	SubIndex 009	9. PDO Mapping entry (0 bits align)	UINT32	RW	0x0000:00, 0
1A55:0A	SubIndex 010	10. PDO Mapping entry (0 bits align)	UINT32	RW	0x0000:00, 0
1A55:0B	SubIndex 011	11. PDO Mapping entry (0 bits align)	UINT32	RW	0x0000:00, 0
1A55:0C	SubIndex 012	12. PDO Mapping entry (0 bits align)	UINT32	RW	0x0000:00, 0
1A55:0D	SubIndex 013	13. PDO Mapping entry (0 bits align)	UINT32	RW	0x0000:00, 0
1A55:0E	SubIndex 014	14. PDO Mapping entry (0 bits align)	UINT32	RW	0x0000:00, 0
1A55:0F	SubIndex 015	15. PDO Mapping entry (0 bits align)	UINT32	RW	0x0000:00, 0
1A55:10	SubIndex 016	16. PDO Mapping entry (0 bits align)	UINT32	RW	0x0000:00, 0

Index 1A56 DRV TxPDO-Map Info data 3 Ch.2

Index (hex)	Name	Meaning	Data type	Flags	Default
1A56:0	DRV TxPDO-Map Info data 3 Ch.2	PDO Mapping TxPDO 87	UINT8	RW	0x01 (1 _{dec})
1A56:01	SubIndex 001	1. PDO Mapping entry (object 0x6110 (DRV Inputs Ch.2), entry 0x14 (Info data 3))	UINT32	RW	0x6110:14, 16
1A56:02	SubIndex 002	2. PDO Mapping entry (0 bits align)	UINT32	RW	0x0000:00, 0
1A56:03	SubIndex 003	3. PDO Mapping entry (0 bits align)	UINT32	RW	0x0000:00, 0
1A56:04	SubIndex 004	4. PDO Mapping entry (0 bits align)	UINT32	RW	0x0000:00, 0
1A56:05	SubIndex 005	5. PDO Mapping entry (0 bits align)	UINT32	RW	0x0000:00, 0
1A56:06	SubIndex 006	6. PDO Mapping entry (0 bits align)	UINT32	RW	0x0000:00, 0
1A56:07	SubIndex 007	7. PDO Mapping entry (0 bits align)	UINT32	RW	0x0000:00, 0
1A56:08	SubIndex 008	8. PDO Mapping entry (0 bits align)	UINT32	RW	0x0000:00, 0
1A56:09	SubIndex 009	9. PDO Mapping entry (0 bits align)	UINT32	RW	0x0000:00, 0
1A56:0A	SubIndex 010	10. PDO Mapping entry (0 bits align)	UINT32	RW	0x0000:00, 0
1A56:0B	SubIndex 011	11. PDO Mapping entry (0 bits align)	UINT32	RW	0x0000:00, 0
1A56:0C	SubIndex 012	12. PDO Mapping entry (0 bits align)	UINT32	RW	0x0000:00, 0
1A56:0D	SubIndex 013	13. PDO Mapping entry (0 bits align)	UINT32	RW	0x0000:00, 0
1A56:0E	SubIndex 014	14. PDO Mapping entry (0 bits align)	UINT32	RW	0x0000:00, 0
1A56:0F	SubIndex 015	15. PDO Mapping entry (0 bits align)	UINT32	RW	0x0000:00, 0
1A56:10	SubIndex 016	16. PDO Mapping entry (0 bits align)	UINT32	RW	0x0000:00, 0

Index 1A57 DRV TxPDO-Map Modes of operation display Ch.2

Index (hex)	Name	Meaning	Data type	Flags	Default
1A57:0	DRV TxPDO-Map Modes of operation display Ch.2	PDO Mapping TxPDO 88	UINT8	RO	0x01 (1 _{dec})
1A57:01	SubIndex 001	1. PDO Mapping entry (object 0x6110 (DRV Inputs Ch.2), entry 0x03 (Modes of operation display))	UINT32	RO	0x6110:03, 8

Index 1A58 DRV TxPDO-Map Torque limitation status Ch.2

Index (hex)	Name	Meaning	Data type	Flags	Default
1A58:0	DRV TxPDO-Map Torque limitation status Ch.2	PDO Mapping TxPDO 89	UINT8	RO	0x01 (1 _{dec})
1A58:01	SubIndex 001	1. PDO Mapping entry (object 0x6110 (DRV Inputs Ch.2), entry 0x15 (Torque limitation status))	UINT32	RO	0x6110:15, 8

Index 1A60 DMC TxPDO-Map Inputs Ch.2

Index (hex)	Name	Meaning	Data type	Flags	Default
1A60:0	DMC TxPDO-Map Inputs Ch.2	PDO Mapping TxPDO 97	UINT8	RO	0x26 (38 _{dec})
1A60:01	SubIndex 001	1. PDO Mapping entry (1 bits align)	UINT32	RO	0x0000:00, 1
1A60:02	SubIndex 002	2. PDO Mapping entry (object 0x6120 (DMC Inputs Ch.2), entry 0x02 (DMC__FeedbackStatus__Latch extern valid))	UINT32	RO	0x6120:02, 1
1A60:03	SubIndex 003	3. PDO Mapping entry (object 0x6120 (DMC Inputs Ch.2), entry 0x03 (DMC__FeedbackStatus__Set counter done))	UINT32	RO	0x6120:03, 1
1A60:04	SubIndex 004	4. PDO Mapping entry (9 bits align)	UINT32	RO	0x0000:00, 9
1A60:05	SubIndex 005	5. PDO Mapping entry (object 0x6120 (DMC Inputs Ch.2), entry 0x0D (DMC__FeedbackStatus__Status of extern latch))	UINT32	RO	0x6120:0D, 1
1A60:06	SubIndex 006	6. PDO Mapping entry (3 bits align)	UINT32	RO	0x0000:00, 3
1A60:07	SubIndex 007	7. PDO Mapping entry (object 0x6120 (DMC Inputs Ch.2), entry 0x11 (DMC__DriveStatus__Ready to enable))	UINT32	RO	0x6120:11, 1
1A60:08	SubIndex 008	8. PDO Mapping entry (object 0x6120 (DMC Inputs Ch.2), entry 0x12 (DMC__DriveStatus__Ready))	UINT32	RO	0x6120:12, 1
1A60:09	SubIndex 009	9. PDO Mapping entry (object 0x6120 (DMC Inputs Ch.2), entry 0x13 (DMC__DriveStatus__Warning))	UINT32	RO	0x6120:13, 1
1A60:0A	SubIndex 010	10. PDO Mapping entry (object 0x6120 (DMC Inputs Ch.2), entry 0x14 (DMC__DriveStatus__Error))	UINT32	RO	0x6120:14, 1
1A60:0B	SubIndex 011	11. PDO Mapping entry (object 0x6120 (DMC Inputs Ch.2), entry 0x15 (DMC__DriveStatus__Moving positive))	UINT32	RO	0x6120:15, 1
1A60:0C	SubIndex 012	12. PDO Mapping entry (object 0x6120 (DMC Inputs Ch.2), entry 0x16 (DMC__DriveStatus__Moving negative))	UINT32	RO	0x6120:16, 1
1A60:0D	SubIndex 013	13. PDO Mapping entry (5 bits align)	UINT32	RO	0x0000:00, 5
1A60:0E	SubIndex 014	14. PDO Mapping entry (object 0x6120 (DMC Inputs Ch.2), entry 0x1C (DMC__DriveStatus__Digital input 1))	UINT32	RO	0x6120:1C, 1
1A60:0F	SubIndex 015	15. PDO Mapping entry (object 0x6120 (DMC Inputs Ch.2), entry 0x1D (DMC__DriveStatus__Digital input 2))	UINT32	RO	0x6120:1D, 1
1A60:10	SubIndex 016	16. PDO Mapping entry (3 bits align)	UINT32	RO	0x0000:00, 3
1A60:11	SubIndex 017	17. PDO Mapping entry (object 0x6120 (DMC Inputs Ch.2), entry 0x21 (DMC__PositioningStatus__Busy))	UINT32	RO	0x6120:21, 1
1A60:12	SubIndex 018	18. PDO Mapping entry (object 0x6120 (DMC Inputs Ch.2), entry 0x22 (DMC__PositioningStatus__In-Target))	UINT32	RO	0x6120:22, 1
1A60:13	SubIndex 019	19. PDO Mapping entry (object 0x6120 (DMC Inputs Ch.2), entry 0x23 (DMC__PositioningStatus__Warning))	UINT32	RO	0x6120:23, 1
1A60:14	SubIndex 020	20. PDO Mapping entry (object 0x6120 (DMC Inputs Ch.2), entry 0x24 (DMC__PositioningStatus__Error))	UINT32	RO	0x6120:24, 1
1A60:15	SubIndex 021	21. PDO Mapping entry (object 0x6120 (DMC Inputs Ch.2), entry 0x25 (DMC__PositioningStatus__Calibrated))	UINT32	RO	0x6120:25, 1
1A60:16	SubIndex 022	22. PDO Mapping entry (object 0x6120 (DMC Inputs Ch.2), entry 0x26 (DMC__PositioningStatus__Accelerate))	UINT32	RO	0x6120:26, 1
1A60:17	SubIndex 023	23. PDO Mapping entry (object 0x6120 (DMC Inputs Ch.2), entry 0x27 (DMC__PositioningStatus__Decelerate))	UINT32	RO	0x6120:27, 1
1A60:18	SubIndex 024	24. PDO Mapping entry (object 0x6120 (DMC Inputs Ch.2), entry 0x28 (DMC__PositioningStatus__Ready to execute))	UINT32	RO	0x6120:28, 1
1A60:19	SubIndex 025	25. PDO Mapping entry (8 bits align)	UINT32	RO	0x0000:00, 8
1A60:1A	SubIndex 026	26. PDO Mapping entry (object 0x6120 (DMC Inputs Ch.2), entry 0x31 (DMC__Set position))	UINT32	RO	0x6120:31, 64

1A60:1B	SubIndex 027	27. PDO Mapping entry (object 0x6120 (DMC Inputs Ch.2), entry 0x32 (DMC__Set velocity))	UINT32	RO	0x6120:32, 16
1A60:1C	SubIndex 028	28. PDO Mapping entry (object 0x6120 (DMC Inputs Ch.2), entry 0x33 (DMC__Actual drive time))	UINT32	RO	0x6120:33, 32
1A60:1D	SubIndex 029	29. PDO Mapping entry (object 0x6120 (DMC Inputs Ch.2), entry 0x34 (DMC__Actual position lag))	UINT32	RO	0x6120:34, 64
1A60:1E	SubIndex 030	30. PDO Mapping entry (object 0x6120 (DMC Inputs Ch.2), entry 0x35 (DMC__Actual velocity))	UINT32	RO	0x6120:35, 16
1A60:1F	SubIndex 031	31. PDO Mapping entry (object 0x6120 (DMC Inputs Ch.2), entry 0x36 (DMC__Actual position))	UINT32	RO	0x6120:36, 64
1A60:20	SubIndex 032	32. PDO Mapping entry (object 0x6120 (DMC Inputs Ch.2), entry 0x37 (DMC__Error id))	UINT32	RO	0x6120:37, 32
1A60:21	SubIndex 033	33. PDO Mapping entry (object 0x6120 (DMC Inputs Ch.2), entry 0x38 (DMC__Input cycle counter))	UINT32	RO	0x6120:38, 8
1A60:22	SubIndex 034	34. PDO Mapping entry (object 0x6120 (DMC Inputs Ch.2), entry 0x39 (DMC__Channel id))	UINT32	RO	0x6120:39, 8
1A60:23	SubIndex 035	35. PDO Mapping entry (object 0x6120 (DMC Inputs Ch.2), entry 0x3A (DMC__Latch value))	UINT32	RO	0x6120:3A, 64
1A60:24	SubIndex 036	36. PDO Mapping entry (object 0x6120 (DMC Inputs Ch.2), entry 0x3B (DMC__Cyclic info data 1))	UINT32	RO	0x6120:3B, 16
1A60:25	SubIndex 037	37. PDO Mapping entry (object 0x6120 (DMC Inputs Ch.2), entry 0x3C (DMC__Cyclic info data 2))	UINT32	RO	0x6120:3C, 16
1A60:26	SubIndex 038	38. PDO Mapping entry (64 bits align)	UINT32	RO	0x0000:00, 64

Index 1A61 DMC TxPDO-Map Inputs 32 Bit Ch.2

Index (hex)	Name	Meaning	Data type	Flags	Default
1A61:0	DMC TxPDO-Map Inputs 32 Bit Ch.2	PDO Mapping TxPDO 98	UINT8	RO	0x2A (42 _{dec})
1A61:01	SubIndex 001	1. PDO Mapping entry (1 bits align)	UINT32	RO	0x0000:00, 1
1A61:02	SubIndex 002	2. PDO Mapping entry (object 0x6120 (DMC Inputs Ch.2), entry 0x02 (DMC__FeedbackStatus__Latch extern valid))	UINT32	RO	0x6120:02, 1
1A61:03	SubIndex 003	3. PDO Mapping entry (object 0x6120 (DMC Inputs Ch.2), entry 0x03 (DMC__FeedbackStatus__Set counter done))	UINT32	RO	0x6120:03, 1
1A61:04	SubIndex 004	4. PDO Mapping entry (9 bits align)	UINT32	RO	0x0000:00, 9
1A61:05	SubIndex 005	5. PDO Mapping entry (object 0x6120 (DMC Inputs Ch.2), entry 0x0D (DMC__FeedbackStatus__Status of extern latch))	UINT32	RO	0x6120:0D, 1
1A61:06	SubIndex 006	6. PDO Mapping entry (3 bits align)	UINT32	RO	0x0000:00, 3
1A61:07	SubIndex 007	7. PDO Mapping entry (object 0x6120 (DMC Inputs Ch.2), entry 0x11 (DMC__DriveStatus__Ready to enable))	UINT32	RO	0x6120:11, 1
1A61:08	SubIndex 008	8. PDO Mapping entry (object 0x6120 (DMC Inputs Ch.2), entry 0x12 (DMC__DriveStatus__Ready))	UINT32	RO	0x6120:12, 1
1A61:09	SubIndex 009	9. PDO Mapping entry (object 0x6120 (DMC Inputs Ch.2), entry 0x13 (DMC__DriveStatus__Warning))	UINT32	RO	0x6120:13, 1
1A61:0A	SubIndex 010	10. PDO Mapping entry (object 0x6120 (DMC Inputs Ch.2), entry 0x14 (DMC__DriveStatus__Error))	UINT32	RO	0x6120:14, 1
1A61:0B	SubIndex 011	11. PDO Mapping entry (object 0x6120 (DMC Inputs Ch.2), entry 0x15 (DMC__DriveStatus__Moving positive))	UINT32	RO	0x6120:15, 1
1A61:0C	SubIndex 012	12. PDO Mapping entry (object 0x6120 (DMC Inputs Ch.2), entry 0x16 (DMC__DriveStatus__Moving negative))	UINT32	RO	0x6120:16, 1
1A61:0D	SubIndex 013	13. PDO Mapping entry (5 bits align)	UINT32	RO	0x0000:00, 5
1A61:0E	SubIndex 014	14. PDO Mapping entry (object 0x6120 (DMC Inputs Ch.2), entry 0x1C (DMC__DriveStatus__Digital input 1))	UINT32	RO	0x6120:1C, 1
1A61:0F	SubIndex 015	15. PDO Mapping entry (object 0x6120 (DMC Inputs Ch.2), entry 0x1D (DMC__DriveStatus__Digital input 2))	UINT32	RO	0x6120:1D, 1
1A61:10	SubIndex 016	16. PDO Mapping entry (3 bits align)	UINT32	RO	0x0000:00, 3
1A61:11	SubIndex 017	17. PDO Mapping entry (object 0x6120 (DMC Inputs Ch.2), entry 0x21 (DMC__PositioningStatus__Busy))	UINT32	RO	0x6120:21, 1
1A61:12	SubIndex 018	18. PDO Mapping entry (object 0x6120 (DMC Inputs Ch.2), entry 0x22 (DMC__PositioningStatus__In-Target))	UINT32	RO	0x6120:22, 1
1A61:13	SubIndex 019	19. PDO Mapping entry (object 0x6120 (DMC Inputs Ch.2), entry 0x23 (DMC__PositioningStatus__Warning))	UINT32	RO	0x6120:23, 1
1A61:14	SubIndex 020	20. PDO Mapping entry (object 0x6120 (DMC Inputs Ch.2), entry 0x24 (DMC__PositioningStatus__Error))	UINT32	RO	0x6120:24, 1
1A61:15	SubIndex 021	21. PDO Mapping entry (object 0x6120 (DMC Inputs Ch.2), entry 0x25 (DMC__PositioningStatus__Calibrated))	UINT32	RO	0x6120:25, 1
1A61:16	SubIndex 022	22. PDO Mapping entry (object 0x6120 (DMC Inputs Ch.2), entry 0x26 (DMC__PositioningStatus__Accelerate))	UINT32	RO	0x6120:26, 1
1A61:17	SubIndex 023	23. PDO Mapping entry (object 0x6120 (DMC Inputs Ch.2), entry 0x27 (DMC__PositioningStatus__Decelerate))	UINT32	RO	0x6120:27, 1
1A61:18	SubIndex 024	24. PDO Mapping entry (object 0x6120 (DMC Inputs Ch.2), entry 0x28 (DMC__PositioningStatus__Ready to execute))	UINT32	RO	0x6120:28, 1
1A61:19	SubIndex 025	25. PDO Mapping entry (8 bits align)	UINT32	RO	0x0000:00, 8
1A61:1A	SubIndex 026	26. PDO Mapping entry (object 0x6120 (DMC Inputs Ch.2), entry 0x31 (DMC__Set position))	UINT32	RO	0x6120:31, 32

1A61:1B	SubIndex 027	27. PDO Mapping entry (32 bits align)	UINT32	RO	0x0000:00, 32
1A61:1C	SubIndex 028	28. PDO Mapping entry (object 0x6120 (DMC Inputs Ch.2), entry 0x32 (DMC__Set velocity))	UINT32	RO	0x6120:32, 16
1A61:1D	SubIndex 029	29. PDO Mapping entry (object 0x6120 (DMC Inputs Ch.2), entry 0x33 (DMC__Actual drive time))	UINT32	RO	0x6120:33, 32
1A61:1E	SubIndex 030	30. PDO Mapping entry (object 0x6120 (DMC Inputs Ch.2), entry 0x34 (DMC__Actual position lag))	UINT32	RO	0x6120:34, 32
1A61:1F	SubIndex 031	31. PDO Mapping entry (32 bits align)	UINT32	RO	0x0000:00, 32
1A61:20	SubIndex 032	32. PDO Mapping entry (object 0x6120 (DMC Inputs Ch.2), entry 0x35 (DMC__Actual velocity))	UINT32	RO	0x6120:35, 16
1A61:21	SubIndex 033	33. PDO Mapping entry (object 0x6120 (DMC Inputs Ch.2), entry 0x36 (DMC__Actual position))	UINT32	RO	0x6120:36, 32
1A61:22	SubIndex 034	34. PDO Mapping entry (32 bits align)	UINT32	RO	0x0000:00, 32
1A61:23	SubIndex 035	35. PDO Mapping entry (object 0x6120 (DMC Inputs Ch.2), entry 0x37 (DMC__Error id))	UINT32	RO	0x6120:37, 32
1A61:24	SubIndex 036	36. PDO Mapping entry (object 0x6120 (DMC Inputs Ch.2), entry 0x38 (DMC__Input cycle counter))	UINT32	RO	0x6120:38, 8
1A61:25	SubIndex 037	37. PDO Mapping entry (8 bits align)	UINT32	RO	0x0000:00, 8
1A61:26	SubIndex 038	38. PDO Mapping entry (object 0x6120 (DMC Inputs Ch.2), entry 0x3A (DMC__Latch value))	UINT32	RO	0x6120:3A, 32
1A61:27	SubIndex 039	39. PDO Mapping entry (32 bits align)	UINT32	RO	0x0000:00, 32
1A61:28	SubIndex 040	40. PDO Mapping entry (object 0x6120 (DMC Inputs Ch.2), entry 0x3B (DMC__Cyclic info data 1))	UINT32	RO	0x6120:3B, 16
1A61:29	SubIndex 041	41. PDO Mapping entry (object 0x6120 (DMC Inputs Ch.2), entry 0x3C (DMC__Cyclic info data 2))	UINT32	RO	0x6120:3C, 16
1A61:2A	SubIndex 042	42. PDO Mapping entry (64 bits align)	UINT32	RO	0x0000:00, 64

Index 1A80 DRV TxPDO-Map Brake Chopper Inputs

Index (hex)	Name	Meaning	Data type	Flags	Default
1A80:0	DRV TxPDO-Map Brake Chopper Inputs	PDO Mapping TxPDO 129	UINT8	RO	0x07 (7 _{dec})
1A80:01	SubIndex 001	1. PDO Mapping entry (2 bits align)	UINT32	RO	0x0000:00, 2
1A80:02	SubIndex 002	2. PDO Mapping entry (object 0xF600 (DRV Brake Chopper Inputs), entry 0x03 (Brake chopper I2T warning))	UINT32	RO	0xF600:03, 1
1A80:03	SubIndex 003	3. PDO Mapping entry (2 bits align)	UINT32	RO	0x0000:00, 2
1A80:04	SubIndex 004	4. PDO Mapping entry (object 0xF600 (DRV Brake Chopper Inputs), entry 0x06 (Brake chopper on))	UINT32	RO	0xF600:06, 1
1A80:05	SubIndex 005	5. PDO Mapping entry (10 bits align)	UINT32	RO	0x0000:00, 10
1A80:06	SubIndex 006	6. PDO Mapping entry (object 0xF600 (DRV Brake Chopper Inputs), entry 0x11 (Brake chopper dutycycle))	UINT32	RO	0xF600:11, 8
1A80:07	SubIndex 007	7. PDO Mapping entry (object 0xF600 (DRV Brake Chopper Inputs), entry 0x12 (Brake chopper I2T utilisation))	UINT32	RO	0xF600:12, 8

Index 1C00 Sync manager type

Index (hex)	Name	Meaning	Data type	Flags	Default
1C00:0	Sync manager type	Using the Sync Managers	UINT8	RO	0x04 (4 _{dec})
1C00:01	SubIndex 001	Sync-Manager Type Channel 1: Mailbox Write	UINT8	RO	0x01 (1 _{dec})
1C00:02	SubIndex 002	Sync-Manager Type Channel 2: Mailbox Read	UINT8	RO	0x02 (2 _{dec})
1C00:03	SubIndex 003	Sync-Manager Type Channel 3: Process Data Write (Outputs)	UINT8	RO	0x03 (3 _{dec})
1C00:04	SubIndex 004	Sync-Manager Type Channel 4: Process Data Read (Inputs)	UINT8	RO	0x04 (4 _{dec})

Index 1C12 RxPDO assign

Index (hex)	Name	Meaning	Data type	Flags	Default
1C12:0	RxPDO assign	PDO Assign Outputs	UINT8	RW	0x04 (4 _{dec})
1C12:01	SubIndex 001	1. allocated RxPDO (contains the index of the associated RxPDO mapping object)	UINT16	RW	0x1610 (5648 _{dec})
1C12:02	SubIndex 002	2. allocated RxPDO (contains the index of the associated RxPDO mapping object)	UINT16	RW	0x1611 (5649 _{dec})
1C12:03	SubIndex 003	3. allocated RxPDO (contains the index of the associated RxPDO mapping object)	UINT16	RW	0x1650 (5712 _{dec})
1C12:04	SubIndex 004	4. allocated RxPDO (contains the index of the associated RxPDO mapping object)	UINT16	RW	0x1651 (5713 _{dec})
1C12:05	SubIndex 005	5. allocated RxPDO (contains the index of the associated RxPDO mapping object)	UINT16	RW	0x0000 (0 _{dec})
1C12:06	SubIndex 006	6. allocated RxPDO (contains the index of the associated RxPDO mapping object)	UINT16	RW	0x0000 (0 _{dec})
1C12:07	SubIndex 007	7. allocated RxPDO (contains the index of the associated RxPDO mapping object)	UINT16	RW	0x0000 (0 _{dec})
1C12:08	SubIndex 008	8. allocated RxPDO (contains the index of the associated RxPDO mapping object)	UINT16	RW	0x0000 (0 _{dec})
1C12:09	SubIndex 009	9. allocated RxPDO (contains the index of the associated RxPDO mapping object)	UINT16	RW	0x0000 (0 _{dec})
1C12:0A	SubIndex 010	10. allocated RxPDO (contains the index of the associated RxPDO mapping object)	UINT16	RW	0x0000 (0 _{dec})
1C12:0B	SubIndex 011	11. allocated RxPDO (contains the index of the associated RxPDO mapping object)	UINT16	RW	0x0000 (0 _{dec})
1C12:0C	SubIndex 012	12. allocated RxPDO (contains the index of the associated RxPDO mapping object)	UINT16	RW	0x0000 (0 _{dec})
1C12:0D	SubIndex 013	13. allocated RxPDO (contains the index of the associated RxPDO mapping object)	UINT16	RW	0x0000 (0 _{dec})
1C12:0E	SubIndex 014	14. allocated RxPDO (contains the index of the associated RxPDO mapping object)	UINT16	RW	0x0000 (0 _{dec})
1C12:0F	SubIndex 015	15. allocated RxPDO (contains the index of the associated RxPDO mapping object)	UINT16	RW	0x0000 (0 _{dec})
1C12:10	SubIndex 016	16. allocated RxPDO (contains the index of the associated RxPDO mapping object)	UINT16	RW	0x0000 (0 _{dec})
1C12:11	SubIndex 017	17. allocated RxPDO (contains the index of the associated RxPDO mapping object)	UINT16	RW	0x0000 (0 _{dec})
1C12:12	SubIndex 018	18. allocated RxPDO (contains the index of the associated RxPDO mapping object)	UINT16	RW	0x0000 (0 _{dec})
1C12:13	SubIndex 019	19. allocated RxPDO (contains the index of the associated RxPDO mapping object)	UINT16	RW	0x0000 (0 _{dec})
1C12:14	SubIndex 020	20. allocated RxPDO (contains the index of the associated RxPDO mapping object)	UINT16	RW	0x0000 (0 _{dec})
1C12:15	SubIndex 021	21. allocated RxPDO (contains the index of the associated RxPDO mapping object)	UINT16	RW	0x0000 (0 _{dec})
1C12:16	SubIndex 022	22. allocated RxPDO (contains the index of the associated RxPDO mapping object)	UINT16	RW	0x0000 (0 _{dec})
1C12:17	SubIndex 023	23. allocated RxPDO (contains the index of the associated RxPDO mapping object)	UINT16	RW	0x0000 (0 _{dec})
1C12:18	SubIndex 024	24. allocated RxPDO (contains the index of the associated RxPDO mapping object)	UINT16	RW	0x0000 (0 _{dec})
1C12:19	SubIndex 025	25. allocated RxPDO (contains the index of the associated RxPDO mapping object)	UINT16	RW	0x0000 (0 _{dec})
1C12:1A	SubIndex 026	26. allocated RxPDO (contains the index of the associated RxPDO mapping object)	UINT16	RW	0x0000 (0 _{dec})
1C12:1B	SubIndex 027	27. allocated RxPDO (contains the index of the associated RxPDO mapping object)	UINT16	RW	0x0000 (0 _{dec})
1C12:1C	SubIndex 028	28. allocated RxPDO (contains the index of the associated RxPDO mapping object)	UINT16	RW	0x0000 (0 _{dec})
1C12:1D	SubIndex 029	29. allocated RxPDO (contains the index of the associated RxPDO mapping object)	UINT16	RW	0x0000 (0 _{dec})
1C12:1E	SubIndex 030	30. allocated RxPDO (contains the index of the associated RxPDO mapping object)	UINT16	RW	0x0000 (0 _{dec})

Index 1C13 TxPDO assign

Index (hex)	Name	Meaning	Data type	Flags	Default
1C13:0	TxPDO assign	PDO Assign Inputs	UINT8	RW	0x06 (6 _{dec})
1C13:01	SubIndex 001	1. allocated TxPDO (contains the index of the associated TxPDO mapping object)	UINT16	RW	0x1A00 (6656 _{dec})
1C13:02	SubIndex 002	2. allocated TxPDO (contains the index of the associated TxPDO mapping object)	UINT16	RW	0x1A10 (6672 _{dec})
1C13:03	SubIndex 003	3. allocated TxPDO (contains the index of the associated TxPDO mapping object)	UINT16	RW	0x1A11 (6673 _{dec})
1C13:04	SubIndex 004	4. allocated TxPDO (contains the index of the associated TxPDO mapping object)	UINT16	RW	0x1A40 (6720 _{dec})
1C13:05	SubIndex 005	5. allocated TxPDO (contains the index of the associated TxPDO mapping object)	UINT16	RW	0x1A50 (6736 _{dec})
1C13:06	SubIndex 006	6. allocated TxPDO (contains the index of the associated TxPDO mapping object)	UINT16	RW	0x1A51 (6737 _{dec})
1C13:07	SubIndex 007	7. allocated TxPDO (contains the index of the associated TxPDO mapping object)	UINT16	RW	0x0000 (0 _{dec})
1C13:08	SubIndex 008	8. allocated TxPDO (contains the index of the associated TxPDO mapping object)	UINT16	RW	0x0000 (0 _{dec})
1C13:09	SubIndex 009	9. allocated TxPDO (contains the index of the associated TxPDO mapping object)	UINT16	RW	0x0000 (0 _{dec})
1C13:0A	SubIndex 010	10. allocated TxPDO (contains the index of the associated TxPDO mapping object)	UINT16	RW	0x0000 (0 _{dec})
1C13:0B	SubIndex 011	11. allocated TxPDO (contains the index of the associated TxPDO mapping object)	UINT16	RW	0x0000 (0 _{dec})
1C13:0C	SubIndex 012	12. allocated TxPDO (contains the index of the associated TxPDO mapping object)	UINT16	RW	0x0000 (0 _{dec})
1C13:0D	SubIndex 013	13. allocated TxPDO (contains the index of the associated TxPDO mapping object)	UINT16	RW	0x0000 (0 _{dec})
1C13:0E	SubIndex 014	14. allocated TxPDO (contains the index of the associated TxPDO mapping object)	UINT16	RW	0x0000 (0 _{dec})
1C13:0F	SubIndex 015	15. allocated TxPDO (contains the index of the associated TxPDO mapping object)	UINT16	RW	0x0000 (0 _{dec})
1C13:10	SubIndex 016	16. allocated TxPDO (contains the index of the associated TxPDO mapping object)	UINT16	RW	0x0000 (0 _{dec})
1C13:11	SubIndex 017	17. allocated TxPDO (contains the index of the associated TxPDO mapping object)	UINT16	RW	0x0000 (0 _{dec})
1C13:12	SubIndex 018	18. allocated TxPDO (contains the index of the associated TxPDO mapping object)	UINT16	RW	0x0000 (0 _{dec})
1C13:13	SubIndex 019	19. allocated TxPDO (contains the index of the associated TxPDO mapping object)	UINT16	RW	0x0000 (0 _{dec})
1C13:14	SubIndex 020	20. allocated TxPDO (contains the index of the associated TxPDO mapping object)	UINT16	RW	0x0000 (0 _{dec})
1C13:15	SubIndex 021	21. allocated TxPDO (contains the index of the associated TxPDO mapping object)	UINT16	RW	0x0000 (0 _{dec})
1C13:16	SubIndex 022	22. allocated TxPDO (contains the index of the associated TxPDO mapping object)	UINT16	RW	0x0000 (0 _{dec})
1C13:17	SubIndex 023	23. allocated TxPDO (contains the index of the associated TxPDO mapping object)	UINT16	RW	0x0000 (0 _{dec})
1C13:18	SubIndex 024	24. allocated TxPDO (contains the index of the associated TxPDO mapping object)	UINT16	RW	0x0000 (0 _{dec})
1C13:19	SubIndex 025	25. allocated TxPDO (contains the index of the associated TxPDO mapping object)	UINT16	RW	0x0000 (0 _{dec})
1C13:1A	SubIndex 026	26. allocated TxPDO (contains the index of the associated TxPDO mapping object)	UINT16	RW	0x0000 (0 _{dec})
1C13:1B	SubIndex 027	27. allocated TxPDO (contains the index of the associated TxPDO mapping object)	UINT16	RW	0x0000 (0 _{dec})
1C13:1C	SubIndex 028	28. allocated TxPDO (contains the index of the associated TxPDO mapping object)	UINT16	RW	0x0000 (0 _{dec})
1C13:1D	SubIndex 029	29. allocated TxPDO (contains the index of the associated TxPDO mapping object)	UINT16	RW	0x0000 (0 _{dec})
1C13:1E	SubIndex 030	30. allocated TxPDO (contains the index of the associated TxPDO mapping object)	UINT16	RW	0x0000 (0 _{dec})

1C13:1F	SubIndex 031	31. allocated TxPDO (contains the index of the associated TxPDO mapping object)	UINT16	RW	0x0000 (0 _{dec})
1C13:20	SubIndex 032	32. allocated TxPDO (contains the index of the associated TxPDO mapping object)	UINT16	RW	0x0000 (0 _{dec})
1C13:21	SubIndex 033	33. allocated TxPDO (contains the index of the associated TxPDO mapping object)	UINT16	RW	0x0000 (0 _{dec})
1C13:22	SubIndex 034	34. allocated TxPDO (contains the index of the associated TxPDO mapping object)	UINT16	RW	0x0000 (0 _{dec})
1C13:23	SubIndex 035	35. allocated TxPDO (contains the index of the associated TxPDO mapping object)	UINT16	RW	0x0000 (0 _{dec})
1C13:24	SubIndex 036	36. allocated TxPDO (contains the index of the associated TxPDO mapping object)	UINT16	RW	0x0000 (0 _{dec})
1C13:25	SubIndex 037	37. allocated TxPDO (contains the index of the associated TxPDO mapping object)	UINT16	RW	0x0000 (0 _{dec})
1C13:26	SubIndex 038	38. allocated TxPDO (contains the index of the associated TxPDO mapping object)	UINT16	RW	0x0000 (0 _{dec})
1C13:27	SubIndex 039	39. allocated TxPDO (contains the index of the associated TxPDO mapping object)	UINT16	RW	0x0000 (0 _{dec})
1C13:28	SubIndex 040	40. allocated TxPDO (contains the index of the associated TxPDO mapping object)	UINT16	RW	0x0000 (0 _{dec})
1C13:29	SubIndex 041	41. allocated TxPDO (contains the index of the associated TxPDO mapping object)	UINT16	RW	0x0000 (0 _{dec})
1C13:2A	SubIndex 042	42. allocated TxPDO (contains the index of the associated TxPDO mapping object)	UINT16	RW	0x0000 (0 _{dec})
1C13:2B	SubIndex 043	43. allocated TxPDO (contains the index of the associated TxPDO mapping object)	UINT16	RW	0x0000 (0 _{dec})

Index 1C32 SM output parameter

Index (hex)	Name	Meaning	Data type	Flags	Default
1C32:0	SM output parameter	Synchronization parameters for the outputs	UINT8	RO	0x20 (32 _{dec})
1C32:01	Sync mode	Current synchronization mode: <ul style="list-style-type: none"> • 0: Free Run • 1: Synchron with SM 2 Event • 2: DC-Mode - Synchron with SYNC0 Event • 3: DC-Mode - Synchron with SYNC1 Event 	UINT16	RW	0x0000 (0 _{dec})
1C32:02	Cycle time	Cycle time (in ns): <ul style="list-style-type: none"> • Free Run: cycle time of the local timer • Synchron with SM 2 Event: cycle time of the master • DC-Mode: SYNC0 / SYNC1 Cycle Time 	UINT32	RW	0x00000000 (0 _{dec})
1C32:03	Shift time	Time between SYNC0 event and output of the outputs (in ns, DC mode only)	UINT32	RO	0x00000000 (0 _{dec})
1C32:04	Sync modes supported	Supported synchronization modes: Bit 0 = 1: Free Run is supported Bit 1 = 1: Synchron with SM 2 Event is supported Bit 2-3 = 01: DC-Mode is supported Bit 4-5 = 10: Output Shift with SYNC1 Event (DC-Mode only) Bit 14 = 1: dynamic times (measurement through writing of 1C32:08)	UINT16	RO	0x0000 (0 _{dec})
1C32:05	Minimum cycle time	Minimum cycle time (in ns)	UINT32	RO	0x00000000 (0 _{dec})
1C32:06	Calc and copy time		UINT32	RO	0x00000000 (0 _{dec})
1C32:07	Minimum delay time		UINT32	RO	0x00000000 (0 _{dec})
1C32:08	Get Cycle Time	<ul style="list-style-type: none"> • 0: Measurement of the local cycle time is stopped • 1: Measurement of the local cycle time is started Entries 1C32:03, 1C32:05, 1C32:06, 1C32:09, 1C33:03, 1C33:06, 1C33:09 are updated with the maximum measured values. For a subsequent measurement the measured values are reset	UINT16	RW	0x0000 (0 _{dec})
1C32:09	Maximum delay time	Time between SYNC1 event and output of the outputs (in ns, DC mode only)	UINT32	RO	0x00000000 (0 _{dec})
1C32:0A	Sync0 Cycle Time		UINT32	RO	0x00000000 (0 _{dec})
1C32:0B	SM event missed counter	Number of missed SM events in OPERATIONAL (DC mode only)	UINT16	RO	0x0000 (0 _{dec})
1C32:0C	Cycle exceeded counter	Number of occasions the cycle time was exceeded in OPERATIONAL (cycle was not completed in time or the next cycle began too early)	UINT16	RO	0x0000 (0 _{dec})
1C32:0D	Shift too short counter	Number of occasions that the interval between SYNC0 and SYNC1 event was too short (DC mode only)	UINT16	RO	0x0000 (0 _{dec})
1C32:20	Sync error	The synchronization was not correct in the last cycle (outputs were output too late; DC mode only)	BOOLEAN	RO	0x00 (0 _{dec})

Index 1C33 SM input parameter

Index (hex)	Name	Meaning	Data type	Flags	Default
1C33:0	SM input parameter	Synchronization parameters for the inputs	UINT8	RO	0x20 (32 _{dec})
1C33:01	Sync mode	Current synchronization mode: <ul style="list-style-type: none"> • 0: Free Run • 1: Synchron with SM 3 Event (no outputs available) • 2: DC - Synchron with SYNC0 Event • 3: DC - Synchron with SYNC1 Event • 34: Synchron with SM 2 Event (outputs available) 	UINT16	RW	0x0000 (0 _{dec})
1C33:02	Cycle time	as 1C32:02	UINT32	RW	0x00000000 (0 _{dec})
1C33:03	Shift time	Time between SYNC0 event and reading of the inputs (in ns, DC mode only)	UINT32	RO	0x00000000 (0 _{dec})
1C33:04	Sync modes supported	Supported synchronization modes: Bit 0: Free Run is supported Bit 1: Synchron with SM 2 Event is supported (outputs available) Bit 1: Synchron with SM 3 Event is supported (no outputs available) Bit 2-3 = 01: DC-Mode is supported Bit 4-5 = 01: Input Shift through local event (outputs available) Bit 4-5 = 10: Input Shift with SYNC1 event (no outputs available) Bit 14 = 1: dynamic times (measurement through writing of 1C32:08 or 1C33:08)	UINT16	RO	0x0000 (0 _{dec})
1C33:05	Minimum cycle time	as 1C32:05	UINT32	RO	0x00000000 (0 _{dec})
1C33:06	Calc and copy time	Time between reading of the inputs and availability of the inputs for the master (in ns, only DC mode)	UINT32	RO	0x00000000 (0 _{dec})
1C33:07	Minimum delay time		UINT32	RO	0x00000000 (0 _{dec})
1C33:08	Get Cycle Time	as 1C32:08	UINT16	RW	0x0000 (0 _{dec})
1C33:09	Maximum delay time	Time between SYNC1 event and reading of the inputs (in ns, only DC mode)	UINT32	RO	0x00000000 (0 _{dec})
1C33:0A	Sync0 Cycle Time		UINT32	RO	0x00000000 (0 _{dec})
1C33:0B	SM event missed counter	as 1C32:11	UINT16	RO	0x0000 (0 _{dec})
1C33:0C	Cycle exceeded counter	as 1C32:12	UINT16	RO	0x0000 (0 _{dec})
1C33:0D	Shift too short counter	as 1C32:13	UINT16	RO	0x0000 (0 _{dec})
1C33:20	Sync error	as 1C32:32	BOOLEAN	RO	0x00 (0 _{dec})

Index F000 Modular Device Profile

Index (hex)	Name	Meaning	Data type	Flags	Default
F000:0	Modular Device Profile	General information for the modular device profile	UINT8	RO	0x02 (2 _{dec})
F000:01	Index distance	Index distance of the objects of the individual channels	UINT16	RO	0x0010 (16 _{dec})
F000:02	Maximum number of modules	Number of channels	UINT16	RO	0x0013 (19 _{dec})

Index F008 Code word

Index (hex)	Name	Meaning	Data type	Flags	Default
F008:0	Code word		UINT32	RW	0x00000000 (0 _{dec})

Index F010 Module Profile List

Index (hex)	Name	Meaning	Data type	Flags	Default
F010:0	Module Profile List		UINT8	RO	0x13 (19 _{dec})
F010:01	SubIndex 001		UINT32	RO	0x00000201 (513 _{dec})
F010:02	SubIndex 002		UINT32	RO	0x000002E6 (742 _{dec})
F010:03	SubIndex 003		UINT32	RO	0x000002EE (750 _{dec})
F010:04	SubIndex 004		UINT32	RO	0x00000000 (0 _{dec})
F010:05	SubIndex 005		UINT32	RO	0x00000000 (0 _{dec})
F010:06	SubIndex 006		UINT32	RO	0x00000000 (0 _{dec})
F010:07	SubIndex 007		UINT32	RO	0x00000000 (0 _{dec})
F010:08	SubIndex 008		UINT32	RO	0x00000000 (0 _{dec})
010F:09	SubIndex 009		UINT32	RO	0x00000000 (0 _{dec})
F010:0A	SubIndex 010		UINT32	RO	0x00000000 (0 _{dec})
F010:0B	SubIndex 011		UINT32	RO	0x00000000 (0 _{dec})
F010:0C	SubIndex 012		UINT32	RO	0x00000000 (0 _{dec})
F010:0D	SubIndex 013		UINT32	RO	0x00000000 (0 _{dec})
F010:0E	SubIndex 014		UINT32	RO	0x00000000 (0 _{dec})
F010:0F	SubIndex 015		UINT32	RO	0x00000000 (0 _{dec})
F010:10	SubIndex 016		UINT32	RO	0x00000000 (0 _{dec})
F010:11	SubIndex 017		UINT32	RO	0x00000201 (513 _{dec})
F010:12	SubIndex 018		UINT32	RO	0x000002E6 (742 _{dec})
F010:13	SubIndex 019		UINT32	RO	0x000002EE (750 _{dec})

Index F081 Download revision

Index (hex)	Name	Meaning	Data type	Flags	Default
F081:0	Download revision		UINT8	RO	0x01 (1 _{dec})
F081:01	Revision number		UINT32	RW	0x00000000 (0 _{dec})

Index FB40 Memory interface

Index (hex)	Name	Meaning	Data type	Flags	Default
FB40:0	Memory interface		UINT8	RO	0x03 (3 _{dec})
FB40:01	Address		UINT32	RW	0x00000000 (0 _{dec})
FB40:02	Length		UINT16	RW	0x0000 (0 _{dec})
FB40:03	Data		OCTET-STRING[8]	RW	{0}

10 Accessories

Braking resistors

Ordering information	Description	Link
ZB8103	Braking resistor 3 Ω	Website
ZB8110	Braking resistor 10 Ω	Website

Cable

Ordering information	Description	Link
ZK4704-04x1-2xxx	Motor cable with itec connector for motors with OCT	Website

Motors

Ordering information	Description	Link
AM8100	Synchronous servomotor	Website

Shield connections

Ordering information	Description	Link
ZB85xx	Shield busbar with mounting rail holder	Website
ZS5300-0015	Shielding bracket for EtherCAT connection of ELM721x / ELM722x EtherCAT Terminals	Website
ZS5300-0016	Shielding bracket for EtherCAT connection of ELM723x EtherCAT Terminals	Website

Additional accessories can be found on the website www.beckhoff.de.

11 Appendix

11.1 Documentation issue status

Version	Comment
1.2	<ul style="list-style-type: none">• Scope of delivery supplemented
1.1	<ul style="list-style-type: none">• Technical data updated• "Connection" chapter updated
1.0	<ul style="list-style-type: none">• First release

11.2 Disposal



Products marked with a crossed-out wheeled bin shall not be discarded with the normal waste stream. The device is considered as waste electrical and electronic equipment. The national regulations for the disposal of waste electrical and electronic equipment must be observed.

11.3 Support and Service

Beckhoff and their partners around the world offer comprehensive support and service, making available fast and competent assistance with all questions related to Beckhoff products and system solutions.

Beckhoff's branch offices and representatives

Please contact your Beckhoff branch office or representative for local support and service on Beckhoff products!

The addresses of Beckhoff's branch offices and representatives round the world can be found on her internet pages: www.beckhoff.com

You will also find further documentation for Beckhoff components there.

Support

The Beckhoff Support offers you comprehensive technical assistance, helping you not only with the application of individual Beckhoff products, but also with other, wide-ranging services:

- support
- design, programming and commissioning of complex automation systems
- and extensive training program for Beckhoff system components

Hotline: +49 5246 963 157
e-mail: support@beckhoff.com
web: www.beckhoff.com/support

Service

The Beckhoff Service Center supports you in all matters of after-sales service:

- on-site service
- repair service
- spare parts service
- hotline service

Hotline: +49 5246 963 460
e-mail: service@beckhoff.com
web: www.beckhoff.com/service

Headquarters Germany

Beckhoff Automation GmbH & Co. KG

Hülshorstweg 20
33415 Verl
Germany

Phone: +49 5246 963 0
e-mail: info@beckhoff.com
web: www.beckhoff.com

More Information:
www.beckhoff.com/elm72xx

Beckhoff Automation GmbH & Co. KG
Hülshorstweg 20
33415 Verl
Germany
Phone: +49 5246 9630
info@beckhoff.com
www.beckhoff.com

