

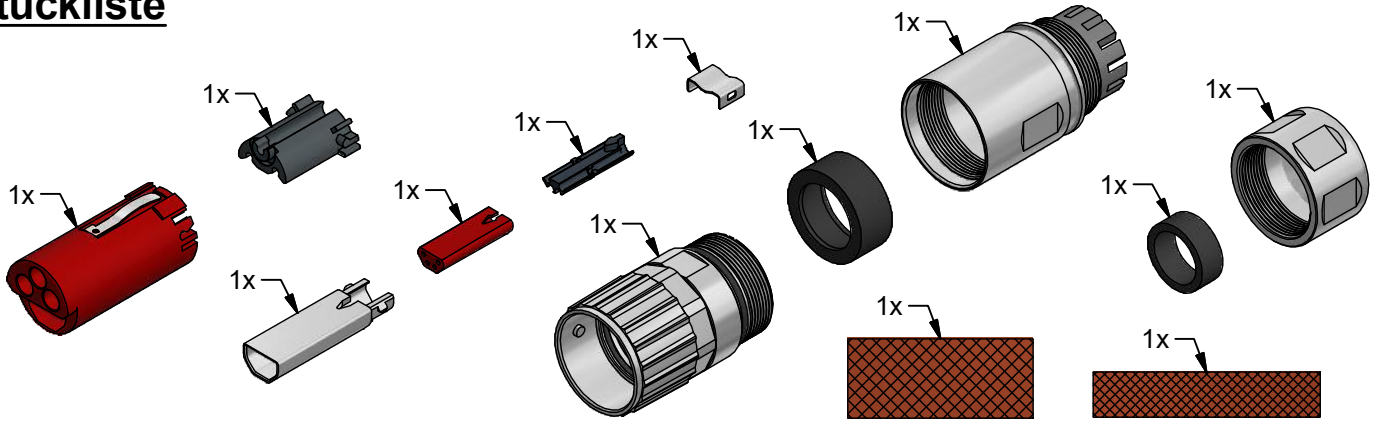

Montageanleitung B17 Hybrid

konfektionierbares Steckergehäuse mit Crimpanschluss, axial,
3x2,5mm² + 4xAWG22, ECP: Powerstift / Datenstift

Stückliste



1 Einzelteile auf Leitung schieben

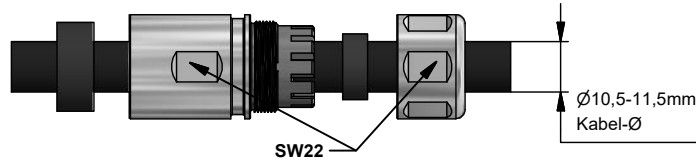

Laufrichtung beachten!

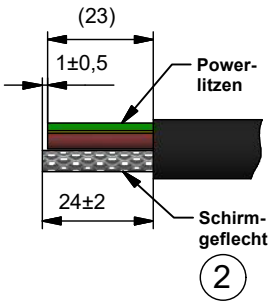

Füllstoffe bündig mit Kabelmantel wegschneiden!

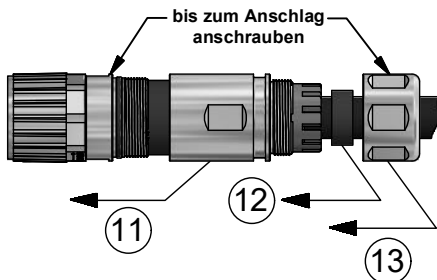
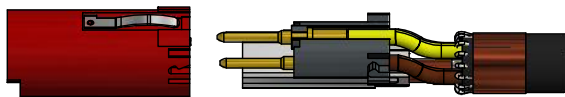
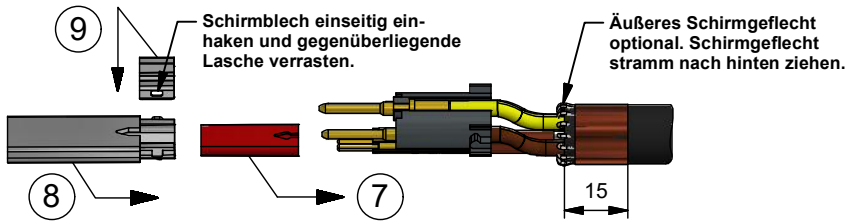
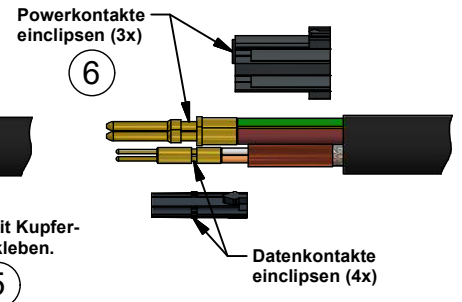
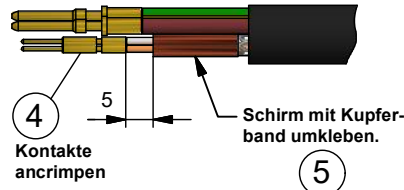
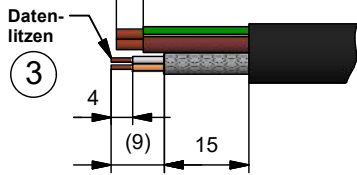

Farbring optional
ZS7200-B005 (rot)
ZS7200-B007 (blau)
ZS7200-B016 (grau)

Achtung: Ansicht von Kabelausgang dargestellt! Auf richtige Farbwahl achten!

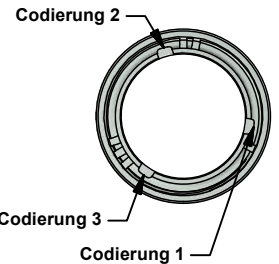
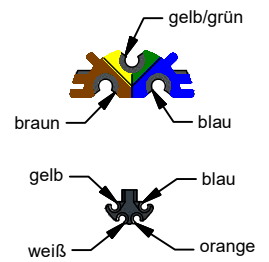

Nur eine Codierung montierbar!

Beckhoff®, TwinCAT®, EtherCAT®, EtherCAT P®, Safety over EtherCAT®, TwinSAFE®, XFC® und XTS® sind eingetragene und lizenzierte Marken der Beckhoff Automation GmbH. Die Verwendung anderer in dieser Dokumentation enthaltener Marken oder Kennzeichen durch Dritte kann zu einer Verletzung von Rechten der Inhaber der entsprechenden Kennzeichen führen.

© Beckhoff Automation GmbH & Co. KG 08/2016

Die Informationen in dieser Druckschrift enthalten lediglich allgemeine Beschreibungen bzw. Leistungsmerkmale, welche im konkreten Anwendungsfall nicht immer in der beschriebenen Form zutreffen bzw. welche sich durch Weiterentwicklung der Produkte ändern können. Die gewünschten Leistungsmerkmale sind nur dann verbindlich, wenn sie bei Vertragsabschluss ausdrücklich vereinbart werden.

Werkzeug / Zubehör

Crimpzange	Crimpeinsatz / Locator
ZB8810-0000	ZB8810-0001

BECKHOFF



Assembly instruction B17 hybrid

field attachable plug housing with crimp connection, axial,
 3x2.5mm² + 4xAWG22, ECP: power (male) / data (male)

parts list

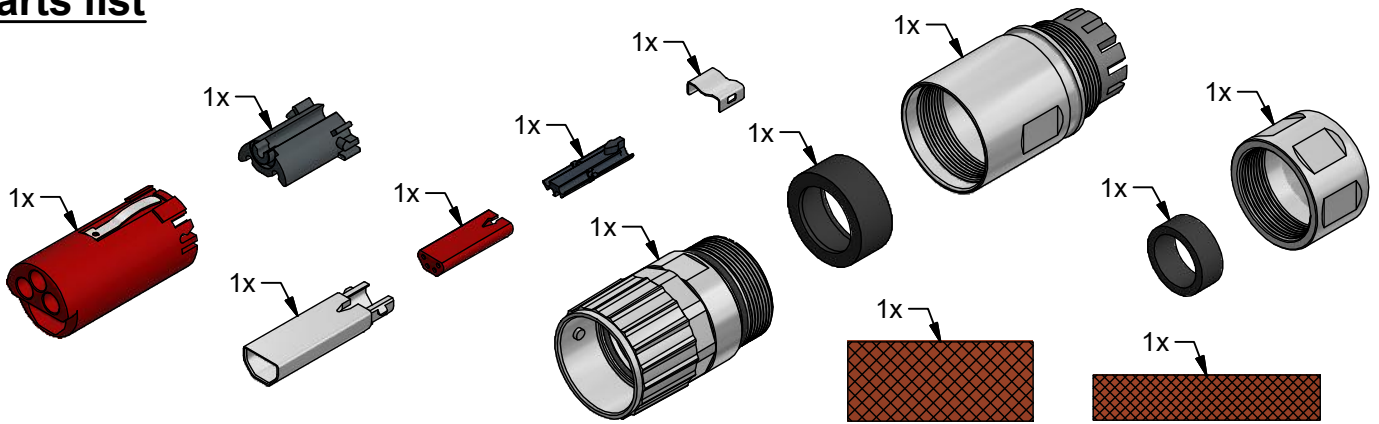

Please consider the cable direction!

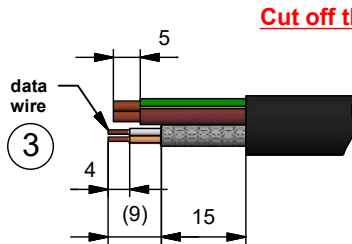
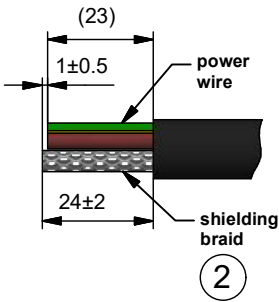
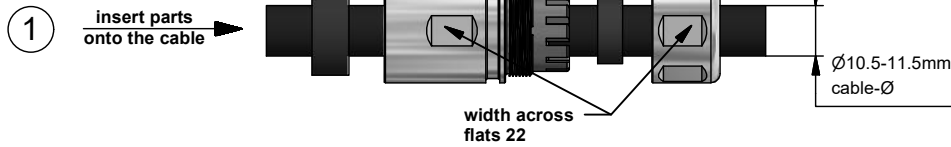

Cut off the fillers!

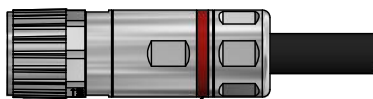
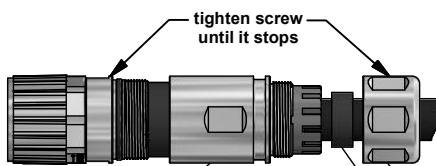
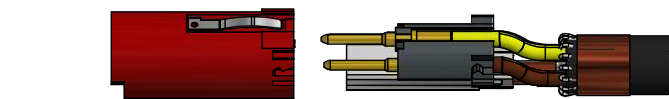
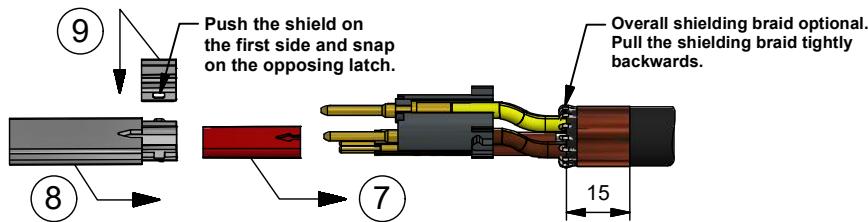
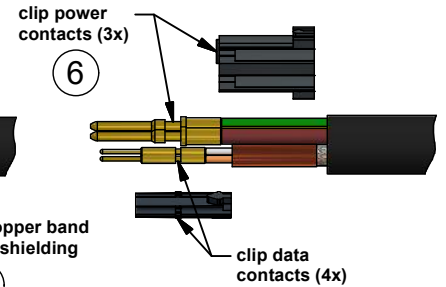
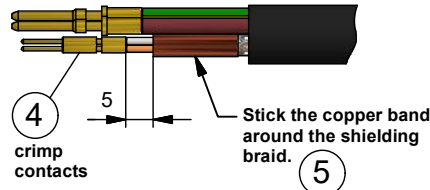

Color ring optional
 ZS7200-B005 (red)
 ZS7200-B007 (blue)
 ZS7200-B016 (grey)

Attention: View from cable outlet!
 Consider the right choice of colors!

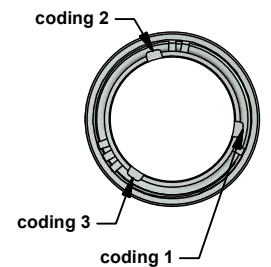
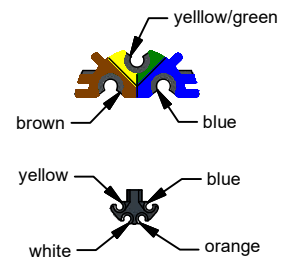

Only one coding mountable!

Beckhoff®, TwinCAT®, EtherCAT®, EtherCAT P®, Safety over EtherCAT®, TwinSAFE®, XFC® and XTS® are registered trademarks of and licensed by Beckhoff Automation GmbH. Other designations used in this publication may be trademarks whose use by third parties for their own purposes could violate the rights of the owners.

© Beckhoff Automation GmbH & Co. KG 08/2016

The information provided in this brochure contains merely general descriptions or characteristics of performance which in case of actual application do not always apply as described or which may change as a result of further development of the products. An obligation to provide the respective characteristics shall only exist if expressly agreed in the terms of contract.

tools / accessory parts

crimping tool	crimping insert / locator
ZB8810-0000	ZB8810-0001

BECKHOFF

790-948800 / 7901A111 Rev. b
 Beckhoff art.-no.: ZS7200 - 0003