

BECKHOFF New Automation Technology

Manual | EN

CP6600

Panel PC



2023-10-09 | Version: 2.6

Table of contents

1	Notes on the documentation	5
2	For your safety	6
2.1	Signal words	6
2.2	Intended use	6
2.3	Fundamental safety instructions	7
2.4	Operator's obligation to exercise diligence	7
2.5	Notes on information security	8
3	Product overview	9
3.1	Structure	10
3.2	Interface description	11
3.2.1	Power supply	11
3.2.2	Ethernet RJ45	12
3.2.3	USB	12
3.2.4	RS232	13
3.3	Status LEDs	14
3.4	Name plate	15
3.5	1-second UPS	16
4	Commissioning	18
4.1	Transport and storage	18
4.2	Control cabinet installation	18
4.2.1	Dimensions	19
4.2.2	Installation in the control cabinet	20
4.3	Connecting the Panel PC	21
4.3.1	Assembly of the supply cable	21
4.3.2	Grounding the Panel PC	23
4.3.3	Connecting cables and power supply	24
4.4	Switching the Panel PC on and off	25
5	Decommissioning	26
5.1	Disconnecting the power supply and cables	26
5.2	Disassembly and disposal	27
6	Maintenance	28
6.1	Cleaning	28
6.2	Maintenance	28
6.2.1	Replacing the battery	30
6.2.2	Replacing the storage medium	31
7	Troubleshooting	32
8	Technical data	33
9	Appendix	34
9.1	Service and support	34
9.2	Approvals	35

1 Notes on the documentation

This description is only intended for the use of trained specialists in control and automation engineering who are familiar with the applicable national standards.

The following instructions and explanations must be followed during installation and commissioning of the components. The responsible staff must ensure that the application or use of the products described satisfy all the requirements for safety, including all the relevant laws, regulations, guidelines and standards.

Disclaimer

The documentation has been prepared with care. The products described are, however, constantly under development. For that reason the documentation is not in every case checked for consistency with performance data, standards or other characteristics. In the event that it contains technical or editorial errors, we retain the right to make alterations at any time and without warning. No claims for the modification of products that have already been supplied may be made on the basis of the data, diagrams, and descriptions in this documentation. All illustrations shown are only examples. The configurations depicted may deviate from the standard.

Trademarks

Beckhoff®, TwinCAT®, TwinCAT/BSD®, TC/BSD®, EtherCAT®, EtherCAT G®, EtherCAT G10®, EtherCAT P®, Safety over EtherCAT®, TwinSAFE®, XFC®, XTS® and XPlanar® are registered and licensed trademarks of Beckhoff Automation GmbH.

Other designations used in this publication may be trademarks whose use by third parties for their own purposes could violate the rights of the owners.

Patents

The EtherCAT Technology is covered, including but not limited to the following patent applications and patents: EP1590927, EP1789857, EP1456722, EP2137893, DE102015105702 and similar applications and registrations in several other countries.

Copyright

© Beckhoff Automation GmbH & Co. KG. Publication of this document on websites other than ours is prohibited. Offenders will be held liable for the payment of damages. All rights reserved in the event of the grant of a patent, utility model or design.

Delivery state

All the components are supplied in particular hardware and software configurations appropriate for the application. Changes to the hardware or software configuration are permitted, provided they are within the specified limits for power consumption and power loss (please refer to the respective data sheet).

Currentness

Please check whether you are using the current and valid version of this document. The current version is always available for download from the Beckhoff website. In case of doubt, contact Technical Support.

Delivery conditions

In addition, the general delivery conditions of the company Beckhoff Automation GmbH & Co. KG apply.

2 For your safety

The signal words and their meanings are explained in the chapter on safety. They contain fundamental safety instructions that are essential for the avoidance of personal injuries and damage to property.

Exclusion of liability

Beckhoff shall not be liable in the event of non-compliance with this documentation and thus the use of the devices outside the documented operating conditions.

2.1 Signal words

The signal words used in the documentation are classified below.

Warning of personal injuries

⚠ DANGER
Hazard with high risk of death or serious injury.
⚠ WARNING
Hazard with medium risk of death or serious injury.
⚠ CAUTION
There is a low-risk hazard that can result in minor injury.

Warning of property and environmental damage

NOTICE
There is a possibility of damage to the environment, equipment or data.

2.2 Intended use

The the Panel PC is intended for use as a control system for automation, visualization and communication in machine and system engineering.

The front of the panel PC is designed for an IP54 working environment. There is complete protection against contact and against dust in harmful quantities, as well as protection against splash water on all sides.

The rear side is designed for a working environment that meets the IP20 protection rating. This involves finger protection and protection against solid foreign objects up to 12.5 mm. There is no protection against water. Operation of the device in wet and dusty environments is not permitted. The specified limits for technical data must be adhered to.

The specified limits for technical data must be adhered to.

The device can be used within the documented operating conditions.

Improper use

Do not use the device outside the documented operating conditions.

2.3 Fundamental safety instructions

The following safety instructions must be observed when handling the the Panel PC.

Application conditions

- Do not use the device under extreme environmental conditions.
- Only use the device in hazardous areas if it is explicitly designed for this purpose.
- Do not carry out any work on the device while it is live. Always switch off the supply voltage for the device before mounting it, replacing device components or rectifying malfunctions. This does not apply to the replacement of hard disks in a RAID configuration.
- Never plug or unplug connectors during thunderstorms. There is a risk of electric shock.
- Ensure that the device has a protective and functional earth connection.

Damage to property, loss of data and impairment of functions

- If you change the hardware and software configurations, you must keep within the specified limits of power consumption and power loss (please refer to the respective data sheet).
- Ensure that only trained specialists with a control and automation engineering background, operate the device. Use by unauthorized persons can lead to damage to property and loss of data.
- In the case of a 24 V DC power supply unit, fuse the power supply line according to its cross-section to protect the supply line in the event of a short circuit.
- In case of fire, extinguish the device with powder or nitrogen.

2.4 Operator's obligation to exercise diligence

The operator must ensure that

- the products are used only for their intended purpose (see Chapter 2.2 [Intended use](#) [▶ 6]).
- the products are only operated in sound condition and in working order.
- the products are operated only by suitably qualified and authorized personnel.
- the personnel is instructed regularly about relevant occupational safety and environmental protection aspects, and is familiar with the operating instructions and in particular the safety instructions contained herein.
- the operating instructions are in good condition and complete, and always available for reference at the location where the products are used.

2.5 Notes on information security

The products of Beckhoff Automation GmbH & Co. KG (Beckhoff), insofar as they can be accessed online, are equipped with security functions that support the secure operation of plants, systems, machines and networks. Despite the security functions, the creation, implementation and constant updating of a holistic security concept for the operation are necessary to protect the respective plant, system, machine and networks against cyber threats. The products sold by Beckhoff are only part of the overall security concept. The customer is responsible for preventing unauthorized access by third parties to its equipment, systems, machines and networks. The latter should be connected to the corporate network or the Internet only if appropriate protective measures have been set up.

In addition, the recommendations from Beckhoff regarding appropriate protective measures should be observed. Further information regarding information security and industrial security can be found in our <https://www.beckhoff.com/secguide>.

Beckhoff products and solutions undergo continuous further development. This also applies to security functions. In light of this continuous further development, Beckhoff expressly recommends that the products are kept up to date at all times and that updates are installed for the products once they have been made available. Using outdated or unsupported product versions can increase the risk of cyber threats.

To stay informed about information security for Beckhoff products, subscribe to the RSS feed at <https://www.beckhoff.com/secinfo>.

3 Product overview

The built-in Panel PC CP6600 is designed for installation in the front of a control cabinet or control housing and can be used in a variety of ways in machine and system engineering.

The Panel PC is suitable for universal use in PLC as well as Motion Control applications in small and medium-sized machines, plants or buildings.

The Panel PC has the following features:

- ARM processor
- 1 x 10/100BASE-T port on-board
- 1 x EtherCAT on-board
- MicroSD
- 2 x USB
- 1 x RS232

Push button extension

You have the possibility to order the Panel PC with the following push button extensions:

- C9900-G072: push button extension for CP6x00 with horizontal 10.1-inch display
- C9900-G073: push button extension for CP6x00 with horizontal 10.1-inch display

For explanations of the push button extensions and the functions, refer to the manual [C9900-G072/G073](#). Figure 1 shows an example of the Panel PC with a push button extension.

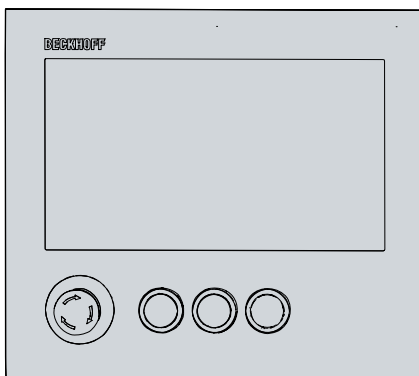

Fig. 1: CP6600_Push button extension

3.1 Structure



Fig. 2: CP6600_Structure

Table 1: Key: C6600 structure

No.	Component	Description
1	Clamping lever	Mounting the Panel PC in the panel of the control cabinet
2	Display and touch screen glass	Operation of the Panel PC
3	Access to interfaces	Interfaces on the underside

3.2 Interface description

The CP6600 has the following interfaces:

- Power supply (X101)
- Ethernet RJ45 (X102)
- EtherCAT (X103)
- USB (X104, X105)
- RS232 (X107)

3.2.1 Power supply

The Panel PC is supplied with a nominal voltage of 24 V. The power supply and the protective earth of the PC are connected via the five-pin voltage socket (X101). The main supply voltage is applied between PIN 4 (0 V) and PIN 5 (24 V) of the socket. If the Panel PC is equipped with an internal, capacitive 1-second UPS (uninterruptible power supply), this is also supplied via the voltage. The 1-second UPS does not serve to back-up the operating system.

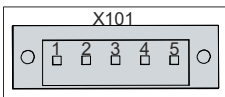

Fig. 3: CP6600_voltage socket pin numbering

Table 2: Voltage socket pin assignment

Pin	Signal	Description
1	NC	not connected
2	NC	not connected
3	⊕	Protective earth
4	GND	0 V
5	24 V	Power supply

The plug for the power supply is specified for 16 A and can accommodate wire cross-sections of up to 1.5 mm². For long supply lines, use 1.5 mm² cables to achieve a low voltage drop on the supply lines. At least 22 V should be present at the power supply plug of the Panel PC so that the PC remains switched on in the event of voltage fluctuations. The plug is included in the delivery. You can obtain a replacement plug from your Beckhoff Sales using the following ordering option:

- C9900-P927: power supply connector for Panel PC CP66xx

Also see about this

📖 1-second UPS [▶ 16]

3.2.2 Ethernet RJ45

The panel PC has an Ethernet RJ45 interface (X102) and an EtherCAT interface (X103). The X102 interface enables the connection of corresponding network components and data rates of 10/100 Mbit/s according to the Ethernet standards 10Base-T and 100Base-T. The X103 interface enables connection to an EtherCAT network.

The RJ45 connection technology with twisted-pair cables is used. The maximum length of the cable connection is 100 m.

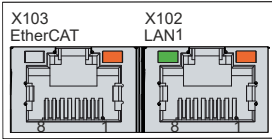

Fig. 4: CP6600_Ethernet interface pin numbering

Table 3: Ethernet interface pin assignment

Pin	Signal	Description
1	T2 +	Pair 2
2	T2 -	
3	T3 +	Pair 3
4	NC	not connected
5	NC	not connected
6	T3 -	Pair 3
7	NC	not connected
8	NC	not connected

The activity is displayed on the basis of the LEDs of the interfaces.

The right LED of the LAN1 interface indicates whether the interface is connected to a network. If this is the case, the LED lights up orange. The LED flashes when data transmission is in progress on the interface.

The left LED of the LAN1 interface indicates the speed of data transmission. If the speed is 100 Mbit/s, the LED lights up green.

At the EtherCAT interface only the right LED is in operation. If the interface is connected to a network, the LED lights up orange. The LED flashes when data transmission is in progress on the interface.

3.2.3 USB

The Panel PC has two USB 2.0 interfaces (X104, X105). They are used to connect peripheral devices with USB interfaces.

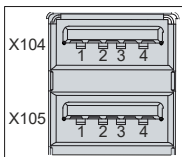

Fig. 5: CP6600_USB interface pin numbering

Table 4: USB interface pin assignment

Pin	Connection
1	Vbus
2	D -
3	D +
4	GND

3.2.4 RS232

The serial interface (X107) is fed out via a 9-pin standard DSUB connector. The signals comply with the RS232 standard.

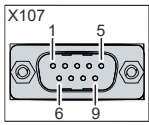

Fig. 6: CP6600_RS232 interface pin numbering

Table 5: RS232 pin assignment

Pin	Signal	Description
1	DCD	Data Carrier Detect
2	RxD	Receive Data
3	TxD	Transmit Data
4	DTR	Data Terminal Ready
5	GND	Ground
6	DSR	Data Set Ready
7	RTS	Request to Send
8	CTS	Clear to Send
9	RI	Rind Indicator

3.3 Status LEDs

The Panel PC has two status LEDs: TC and PWR. They provide information on the following aspects:

- the TwinCAT status
- the status of the power controller

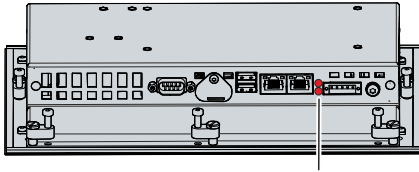

Fig. 7: CP6600_Status LEDs

LED TC

The upper TC LED indicates the TwinCAT status. The colors and flashing intervals have the following meanings:

Table 6: Meaning of the TC LED

Color	Flashing interval	Meaning
Red	Steadily lit	TwinCAT Stop
Green	Steadily lit	TwinCAT Run Mode
Blue	Steadily lit	TwinCAT Config Mode
-	-	TwinCAT not started

LED PWR

The lower PWR (power) LED indicates the status of the power controller. The colors and flashing intervals have the following meanings:

Table 7: Meaning of the PWR LED

Color	Flashing interval	Meaning
Green	Steadily lit	Connection to power supply unit with power supply switched on
Red	Flashing rapidly	Error in the power supply
Red	Flashing slowly	No or faulty MicroSD card inserted

3.4 Name plate

The name plate provides information on the equipment fitted to the Panel PC. The name plate shown here serves only as an example.

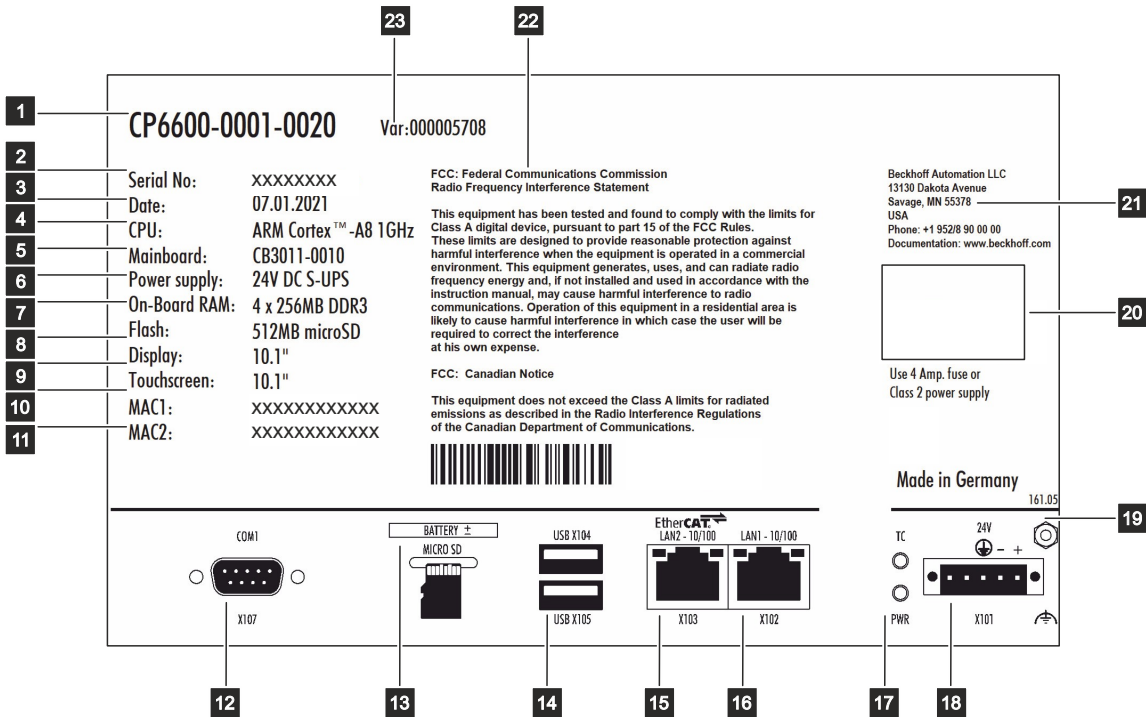





Fig. 8: CP6600_name plate

Table 8: Key: name plate CP6600

No.	Description
1	Model: the last four digits indicate the device generation.
2	Serial number
3	Date of manufacture
4	CPU
5	Mainboard
6	Power supply
7	Main memory
8	Storage medium
9	Display
10	Touch screen
11	MAC addresses of the Ethernet interfaces
12	RS232 interface (X107)
13	Battery and MicroSD
14	USB interfaces (X104, X105)
15	EtherCAT interface (X103)
16	Ethernet interface (X102)
17	Status LEDs
18	Connection of the power supply and protective earth of the Panel PC (X101)
19	Grounding bolt for functional earthing of the Panel PC
20	Symbols <div style="text-align: right; margin-right: 50px;">    </div> <p>Note: here are the symbols applicable to the device such as CE, EAC, UKCA, . The approvals of your device can be found on the name plate and in chapter 9.2 Approvals.</p>
21	Address of the vendor
22	FCC approval
23	Variant number: commercial number of the order code including ordering options

3.5 1-second UPS

NOTICE

Loss of data

Using the 1-second UPS in a way that is not documented as an option can lead to loss or corruption of data.

- Only use TwinCAT to control the 1-second UPS and only save persistent data with a maximum size of 1 MB.

There is an option to order the industrial PC with an internal uninterruptible power supply (UPS). This is a capacitive 1-second UPS for reliable saving of persistent application data on the storage medium. This requires TwinCAT and Windows Embedded Compact 7.

You can order the industrial PC with internal UPS ex factory by specifying the order identifier C9900-U213.

The capacitive 1-second UPS continues to supply the processor with power if the power supply fails. During this period, persistent data can be saved, which are available when the device is switched on again. Since the capacity of the 1-second UPS is neither sufficient for bridging power failures nor for operating a hard disk, in the event of a power failure the data is only stored on the Compact Flash/CFast/MicroSD card. The 1-second UPS only works for a few seconds.

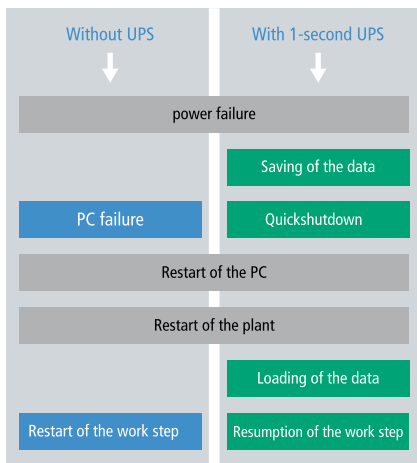

Fig. 9: UPS function

The UPS can be controlled from the PLC with the function block FB_S_UPS_CB3011. For more information, please visit the Beckhoff Information System at the following link: https://infosys.beckhoff.com/english.php?content=../content/1033/tcplclib_tc2_sups/2220095883.html&id=

4 Commissioning

Operation of the Panel PC

The Panel PC is operated via the touch screen.

NOTICE

Damage to the touch screen

Operating the touch screen with unsuitable objects may damage the touch screen.

- Only operate the touch screen with your bare finger or with your finger using a suitable glove.
- If you use gloves, make sure that no hard particles such as metal shavings, glass splinters or similar adhere to the glove.

Commissioning

In order to use the Panel PC, you must first commission it. The first step is to transport the device to its operating location and unpack it. This is followed by installing the device in the panel of the control cabinet, connecting the cables and the power supply and finally switching on the Panel PC.

4.1 Transport and storage

The specified storage conditions must be adhered to (see chapter 8 [Technical data](#) [► 33]).

Despite the robust design of the unit, the components are sensitive to strong vibrations and impacts. During transport the device must therefore be protected from mechanical stress. Appropriate packaging of the Panel PC, in particular the original packaging, can improve the vibration resistance during transport.

NOTICE

Hardware damage due to condensation

Unfavorable weather conditions during transport can cause damage to the device.

- Protect the device against moisture (condensation) during transport in cold weather or in case of extreme temperature fluctuations.
- Do not put the device into operation until it has slowly adjusted to the room temperature.
- Should condensation occur, wait for about 12 hours before switching the device on.

Unpacking

Proceed as follows to unpack the device:

1. Check the packaging for transport damage.
2. Remove packaging.
3. Keep the packaging for possible future transport.
4. Check your delivery for completeness by comparing it with your order.
5. Check the contents for visible shipping damage.
6. In case of discrepancies between the package contents and the order, or in case of transport damage, please inform Beckhoff Service (see Chapter 9.1 Service and Support).

4.2 Control cabinet installation

NOTICE

Lack of air circulation

Incorrect installation of the panel PC prevents air circulation in the device and thus causes overheating and functional impairment.

- Only install the panel PC as shown in the corresponding wall in the orientation shown.

The Panel PC CP6600 is designed for installation in the front of a control cabinet in machine and system engineering. The environmental conditions specified for operation must be observed (see chapter 8 [Technical data](#) [▶ 33]).

4.2.1 Dimensions

The dimensions of the Panel PC are required for the preparation of the control cabinet front. For the installation of the Panel PC, the wall thickness must be between 1 mm and 5 mm. After installation, be sure to check the tightness between the Panel PC and the built-in wall.

All dimensions are in mm.

Figure 9 shows the dimensions of the Panel PC without push button extension.

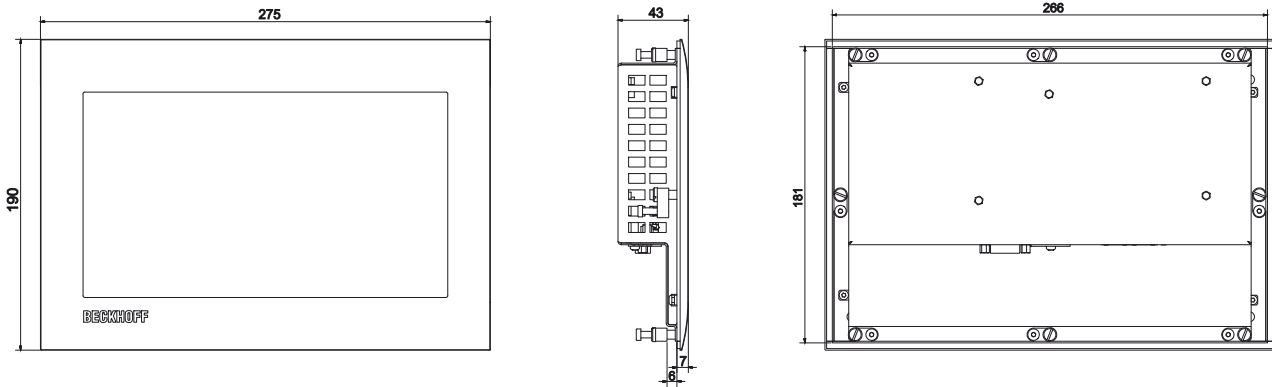

Fig. 10: CP6600_dimensions

Figure 10 shows the dimensions of the Panel PC with push button extension.

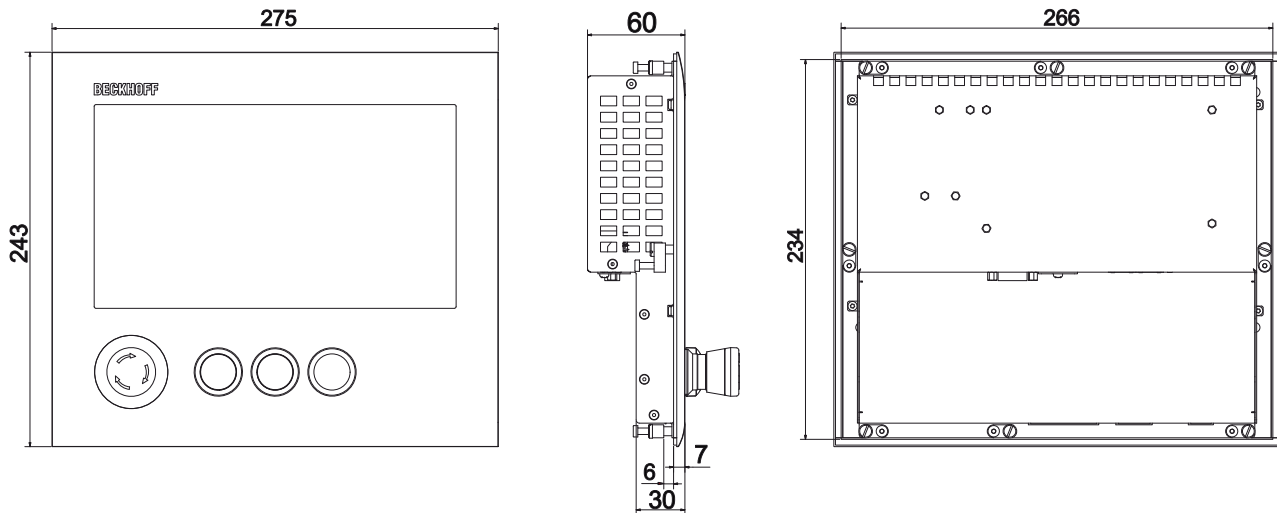

Fig. 11: CP6600_dimensions push button extension

4.2.2 Installation in the control cabinet

The control cabinet must have the required installation cutout according to the device dimensions (see Chapter 4.2.1 [Dimensions \[► 19\]](#)) of the Panel PC.

NOTICE

Extreme environmental conditions

Extreme environmental conditions can cause damage to the device.

- Avoid extreme environmental conditions.
- Protect the device against dust, moisture and heat.
- Do not block the ventilation slots of the device.

Please also note the following for installation in a control cabinet:

- For air circulation, ensure that there is 5 cm of free space above and below the device.
- Position the Panel PC such that reflections from light sources on the screen are avoided as far as possible.
- For the correct installation height, use the position of the screen for guidance. This should always be optimally visible to the user.
- Do not expose the Panel PC to direct sunlight.

Installation in the control cabinet

Once you have made the required cutout in the control cabinet, you can install the Panel PC in the control cabinet. Clamping levers are provided at the back of the housing for final mounting of the device.

To install and secure the Panel PC in the control cabinet, follow the steps shown in Fig. 11:

1. Insert the Panel PC at the intended position in the panel of the control cabinet. Make sure that the device is secured against falling out until it is fastened properly.
2. Loosen the clamping levers with a 2.5 mm Allen key (sections A and B).
3. Fold out the clamping levers 90° (section C).
4. Retighten the clamping levers with the Allen key (section D).

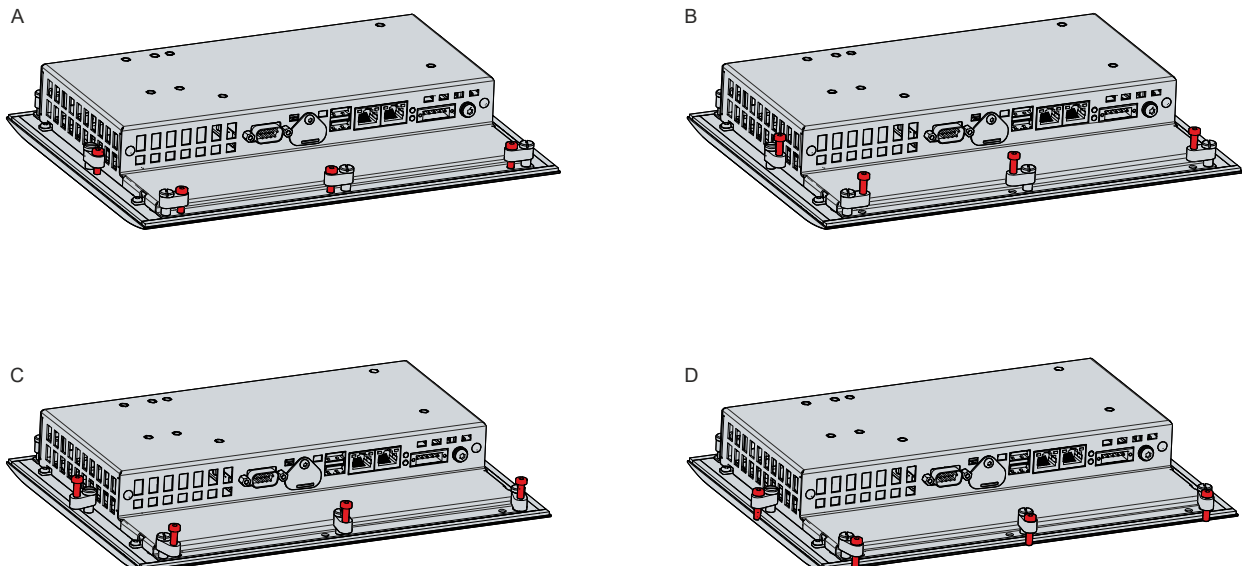

Fig. 12: CP6600_control cabinet installation

4.3 Connecting the Panel PC

⚠ CAUTION

Risk of electric shock

Dangerous touch voltages can lead to electric shock. To avoid electric shock, observe the following:

- Never connect or disconnect the device cables during a thunderstorm.
- Provide protective earthing for handling the device.

To make the panel PC ready for operation, you have to connect it. The first step is to ground the device. Then you can connect the cables and the power supply.

An external power supply unit providing 24 V DC (-15 %/+20 %) from an isolated source is required for the power supply. This source must be protected by a UL 248 rated fuse with a maximum rating of 4 A.

The cabling of the panel PC in the control cabinet must be done in accordance with the standard EN 60204-1:2006 PELV = Protective Extra Low Voltage:

- The PE conductor (protective earth) and the "0 V" conductor of the voltage source must be on the same potential (connected in the control cabinet).
- Standard EN 60204-1:2006, section 6.4.1:b stipulates that one side of the circuit, or a point of the energy source for this circuit must be connected to the protective conductor system.

Devices connected to the panel PC with their own power supply must have the same potential for the PE and "0 V" conductors as the panel PC (no potential difference).

4.3.1 Assembly of the supply cable

Install the cable for the power supply of the Panel PC using the material supplied for connector assembly. It consists of a 5-pin connection strip and a strain relief housing with cable tie.

If you require a replacement for the voltage connector or the strain relief housing, you can order these from Beckhoff Sales.

Assembly of the supply cable

First mount the plug on the cable as follows:

1. Remove the insulation from the cable ends (8-9 mm).
2. Crimp the ferrules onto the stripped cable ends.
3. Insert the cable ends with the ferrules into the 5-pin connection strip. For the pin assignment of the connector, see Chapter 3.2.1 [Power supply](#) [▶ 11].
4. Screw the cable ends into the 5-pin connection strip.

Assembly of strain relief housing

Now mount the strain relief housing on the previously connected plug and supply cable as shown in Fig. 12:

1. Thread the cable tie into the lower part of the strain relief housing (section A).
2. Insert the connection strip into the lower part of the strain relief housing (section B).
3. Tighten the cable tie and remove the plastic tab (section C).
4. Attach the upper part of the strain relief housing by snapping it onto the lower part (section D).

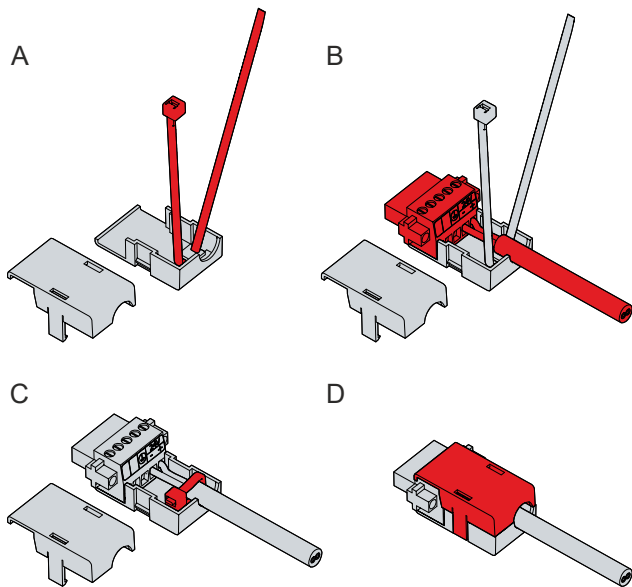

Fig. 13: CP6600_Assembly of strain relief housing

To remove the strain relief housing, proceed as follows:

1. Use your fingers to bend the latching lugs on the lower part slightly outward (see Fig. 13).
2. Lever the upper part off the lower part.
3. Cut the cable tie.

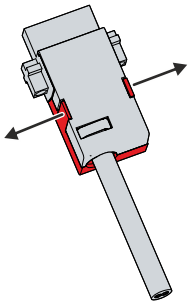

Fig. 14: CP6600_Disassembly of strain relief housing

4.3.2 Grounding the Panel PC

Potential differences are minimized and electrical currents are diverted to the ground through grounding or potential equalization of electronic devices. This is to prevent dangerous touch voltages and electromagnetic interference.

On the back of the Panel PC, next to the interfaces, there is the grounding bolt, via which the functional earth of the PC is ensured (see Fig. 14). Use cables with a minimum cross-section of 4 mm² for the ground connection.

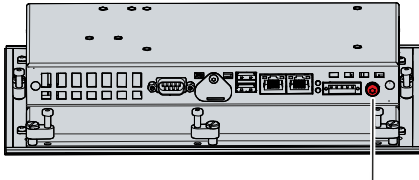

Fig. 15: CP6600_Grounding bolt for functional earthing

Protective earth

Establish low-resistance protective earthing of the Panel PC via the voltage connection to avoid dangerous touch voltages. There is a pin in the voltage socket for the protective earth (PE).

EMC

NOTICE

Hardware damage due to electromagnetic interference

The use of the Panel PC without a functional earth can lead to material damage due to electromagnetic interference.

- Only use the device with functional earth.

Electromagnetic compatibility (EMC) of the Panel PC includes on the one hand not affecting other devices and equipment by electromagnetic interference and on the other hand not being disturbed by electrical or electromagnetic effects itself.

To do this, the Panel PC must comply with certain protection requirements. The Panel PC has EMC interference immunity according to EN 61000-6-2. The EMC interference emission of the device meets the requirements of EN 61000-6-4.

The functional earth is necessary for the EMC of the device.

4.3.3 Connecting cables and power supply

NOTICE

Incorrect connection procedure

Incorrect procedure when connecting the cables and the power supply can cause hardware damage.

- Follow the documented procedure for connecting the cables and the power supply.
- Always connect all cables first and only then switch on the power supply.
- Please read the documentation for the external devices prior to connecting them.

The connections are located at the rear of the panel PC.

Connecting cables

Make sure that you first ground the PC (see chapter 4.3.2 [Grounding the panel PC](#) [▶ 23]) and then plug in all data transmission cables.

Connecting the power supply

Cables with a maximum cable cross-section of 1.5 mm^2 can be used for connecting the power supply. For long supply lines, use 1.5 mm^2 cables to achieve a low voltage drop on the supply line. There should be at least 22 V at the voltage connector of the panel PC, so that the PC remains switched on during voltage fluctuations.

Proceed as follows to connect the 24 V_{DC} power supply unit:

1. First mount the power supply cable with the 5-pin connection strip without its strain relief housing.
2. Plug the voltage connector into the voltage socket on the panel PC.
3. Screw the voltage connector to the voltage socket.
4. Connect the PC to your external 24 V power supply.
5. Switch on the 24 V power supply.
6. Measure the voltage on the power supply plug of the PC.
7. Mount the strain relief housing on the 5-pin connection strip.

4.4 Switching the Panel PC on and off

First switching on and driver installation

NOTICE

Public networks

Connecting the PC to public networks without additional protective measures can compromise the safety of the device.

- Protect the PC before connecting it to public networks.

The panel PC starts up when the system is switched on or when the power supply is connected.

When you switch on the panel PC for the first time, the optional pre-installed operating system starts. For any additional hardware you have connected, you have to install the drivers yourself afterwards.

If you have ordered the PC without an operating system, you must install this and the driver software for the additional hardware you have connected and for the devices in the PC yourself. Please follow the instructions in the documentation for the operating system and the additional devices.

Switching off the panel PC

NOTICE

Data loss due to switching off the PC while the software is running

Switching off the PC before the running software is terminated and the operating system is shut down can lead to data loss.

- Quit the running software and shut down the operating system before switching off the PC.

When the system is switched off or disconnected from its own power supply, the panel PC is also switched off.

You can assign different access rights to all users in the operating system and in the application software. Since there is a risk of data loss if the panel PC is switched off incorrectly, assign the rights advisedly. A user who is not allowed to terminate the software should not be allowed to switch off the panel PC.

5 Decommissioning

NOTICE

Hardware damage due to power supply

A connected power supply can cause damage to the Panel PC during disassembly.

- Disconnect the power supply from the device before starting to disassemble it.

As part of the decommissioning of the Panel PC, you must first disconnect the power supply and cables. You can then remove the device from the control cabinet front.

If you do not wish to use the Panel PC any further, chapter 5.2 [Disassembly and disposal](#) [▶ 27] provides information on the correct disposal of the device.

5.1 Disconnecting the power supply and cables

⚠ CAUTION

Risk of electric shock

Disconnecting the panel PC during a thunderstorm can lead to electric shock.

- Never disconnect the cables from the device during thunderstorms.

Before you remove the panel PC from the control cabinet, you must disconnect the power supply and the cables. Follow the steps below:

1. Shut down the operating system.
 2. Disconnect the panel PC from your external 24 V power supply.
 3. Unscrew the 5-pin voltage connector and pull it out of the PC.
 4. Remove the power supply cable if the five-pin connector is to remain with the PC.
 5. Make a note of the wiring of all data transmission cables if you want to restore the cabling with another device.
 6. Disconnect all data transmission cables from the panel PC.
 7. Finally, disconnect the ground connection.
- ⇒ You have disconnected the power supply and the cables.

5.2 Disassembly and disposal

Before you can remove the Panel PC from the control cabinet front, you must first disconnect the power supply and the cables (see chapter 5.1 [Disconnecting the power supply and cables \[► 26\]](#)).

To remove the Panel PC from the control cabinet front, follow the steps shown in Fig. 15:

1. Loosen the clamping levers with a 2.5 mm Allen key (sections A and B). Make sure that the device is secured against falling out until it is removed from the wall.
2. Fold the clamping levers back by 90° onto the housing (section C).
⇒ You can now remove the Panel from the control cabinet.
3. To reattach the clamping levers to the housing, retighten them with the Allen key (section D).

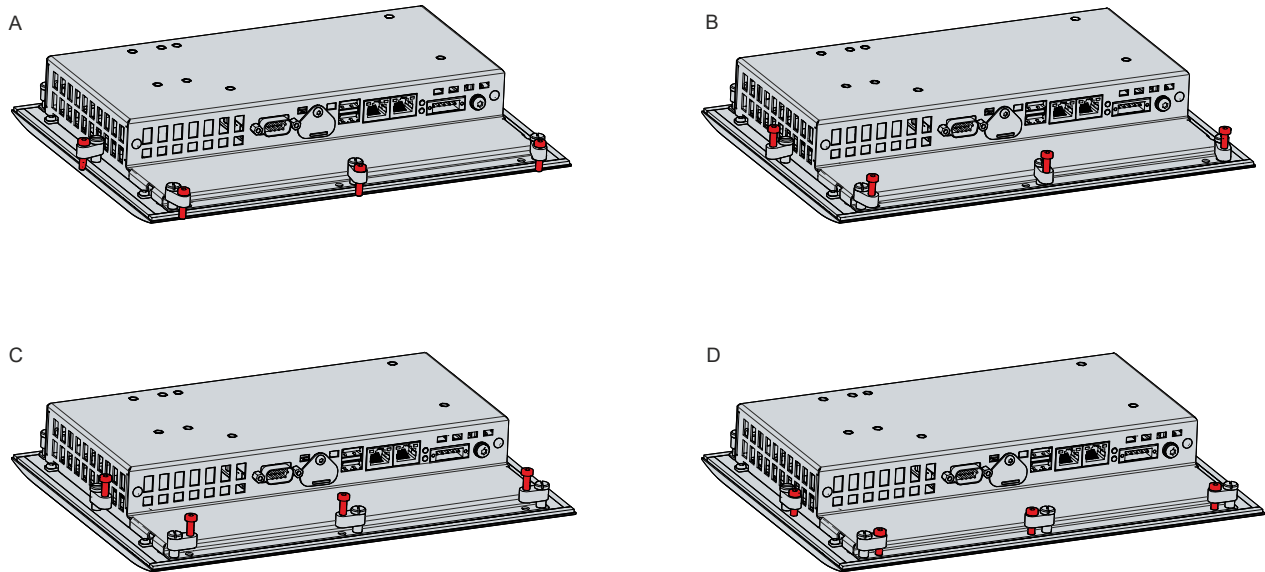

Fig. 16: CP6600_Removal from the control cabinet

Disposal of the Panel PC

When disposing of the Panel PC, be sure to observe the national electronic waste regulations.

6 Maintenance

⚠ CAUTION

Risk of electric shock

Working on the Panel PC when live can lead to electric shock.

- Turn off the supply voltage before cleaning the device or replacing device components.

Maintenance measures increase the efficiency of the device by ensuring long-term functionality. Cleaning and maintenance of certain device components and the replacement of other device components contribute to this.

Repair

Only the manufacturer may repair the device. If a repair should be necessary, contact Beckhoff Service (see Chapter 9.1 [Service and Support](#) [▶ 34]).

6.1 Cleaning

NOTICE

Unsuitable cleaning agents

The use of unsuitable cleaning agents can damage the device.

- Clean the Panel PC only as specified.

It is essential to observe the following points when cleaning the PC:

- Keep to the boundary conditions of protection rating IP65.
- Never use compressed air to clean the PC.
- Maintain an ambient temperature range of 0 °C to 55 °C.

Cleaning agents

In order to avoid damage to the front of the Panel PC during cleaning, you must use suitable cleaning agents. Examples include:

- Benzine
- Spirit
- Glass cleaner

Avoid the following cleaning agents:

- Detergents with scouring or abrasive components
- Metal cleaning objects such as razor blades or steel spatulas
- Steam jet cleaner or very hot water
- Cold water with a heated device
- High water pressure, e.g. high-pressure cleaner

6.2 Maintenance

NOTICE

Use of incorrect spare parts

The use of spare parts not ordered from Beckhoff Service can lead to unsafe and faulty operation.

- Only use spare parts that you have ordered from Beckhoff Service.

Beckhoff Panel PCs are manufactured from components of the highest quality and robustness. They are selected and tested for best interoperability, long-term availability and reliable function under the specified environmental conditions.

Nevertheless, some components of the Panel PC may be subject to a limited service life if they are operated under certain conditions, such as more demanding ambient conditions during operation or during storage, or if they are out of service for long periods of storage.

Beckhoff therefore recommends replacing some of the Panel PC components after the time after which predictions of the remaining service life of such components can no longer be reliably calculated.

These are the following components:

- Battery
- Storage medium

The following table provides recommendations for the regular, precautionary replacement of the PC components:

Table 9: Replacement recommendations for PC components

Component	Recommendation for replacement intervals (years)
UPS battery pack	5 years
2.5-inch hard disk	5 years or after 20,000 operating hours at more than 40 °C or after 30,000 operating hours at less than 40 °C
3.5-inch hard disk	5 years, irrespective of the operating hours
Fan	7 years
Compact Flash, CFast or SSD	10 years
Motherboard battery	5 years

Beckhoff is excluded from liability in the event of possible damage occurring during maintenance work. In order to avoid damage caused by electrostatic discharge when replacing device components, protective measures are recommended. Below are some suggestions.

ESD protection

NOTICE
<p>Electrostatic discharge</p> <p>The replacement of device components without ESD protection can lead to functional impairment and destruction of the device.</p> <ul style="list-style-type: none"> • If possible, apply ESD protection measures during maintenance work.

When working on electronic devices, there is a risk of damage due to ESD (electrostatic discharge), which can impair the function or destroy the device.

Protect the Panel PC and create an ESD-protected environment in which existing electrostatic charges are safely discharged to ground and charging is prevented.

An ESD-protected environment can best be created by setting up ESD protection zones. The following measures serve this purpose:

- ESD-compliant floors with sufficient conductivity to the reference potential PE;
- ESD-compatible work surfaces such as tables and shelves;
- Wrist grounding strap, especially for sedentary activities;
- grounded and electrostatically dissipating equipment and operating materials (e.g. tools) within the ESD protection zone.

If it is not possible to create an ESD protection zone, you can still protect the device against ESD damage. For example, the following measures can be used:

- Use conductive mats connected to the ground potential as underlays.
- Dissipate possible charges from your own body by touching grounded metal (e.g. control cabinet door).
- Wear a wrist grounding strap.
- Only remove new electronic components from the ESD packaging (tinted plastic bag) after putting on the wrist grounding strap.

- Do not walk around with electronic components in your hand if they are not in ESD packaging.

Access to battery and storage medium

To be able to replace the battery and the storage medium, you must first gain access to these device components. You can access the battery and the storage medium via the cover next to the interfaces on the back of the Panel PC. To do this, loosen the Phillips screw and remove the cover (see Fig. 16).

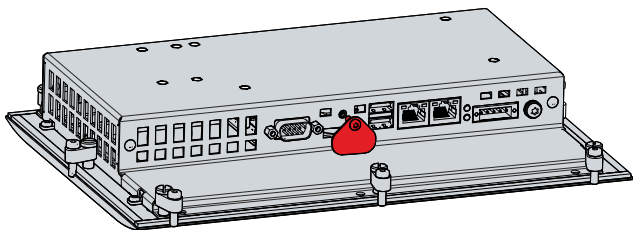

Fig. 17: CP6600_Access to battery and storage medium

You now have access to the battery and the storage medium.

6.2.1 Replacing the battery

NOTICE

Incorrect battery type

Replace the battery with R/C (BBCV2), order number CR2032, nominal voltage 3 V. Using any other battery may cause fire or explosion.

- Only replace the battery with a replacement battery from Beckhoff Service.
- When replacing the battery, make sure that the polarity is correct.

NOTICE

Battery damage

Incorrect handling of the motherboard battery can damage it.

- Do not recharge the battery.
- Do not throw the battery on the fire.
- Do not open the battery.
- Protect the battery against direct sunlight and moisture.

NOTICE

Motherboard failure

Scratches on the motherboard may cause the motherboard to fail.

- Be very careful when replacing the battery and be sure to avoid scratches on the motherboard.

The Panel PC does not contain a lithium-ion battery. The motherboard battery is a CR2032 lithium-metal cell. It is used to supply power to the clock integrated on the motherboard. If the battery is depleted or missing, the date and time are displayed incorrectly.

Table 10: Technical data of the battery

Battery type	Electrical properties (at 20 °C)		Dimensions		
	Nominal voltage	Nominal capacity	Diameter	Height	Weight
CR2032	3.0 V	225 mAh	20.0 mm	3.20 mm	3.1 g

Chapter 7.2 [Maintenance](#) [► 28] shows how to access the battery.

To change the battery, proceed as follows:

1. Pull the battery out of the Panel PC with needle-nose pliers.
2. Insert the new battery into the PC by hand. Make sure that the polarity is correct as shown in Fig. 17.

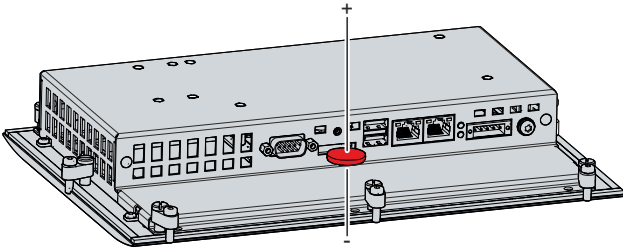

Fig. 18: CP6600_Replacing the battery

To dispose of the battery, remove it, tape off the poles and put it in the battery disposal.

6.2.2 Replacing the storage medium

New storage media should only be obtained from Beckhoff Service (see Chapter 9.1 Service and Support).

The CP6600 contains a MicroSD.

Data transmission before replacement

If you want to exchange a storage medium according to Beckhoff's recommendation, you must copy the data from the old to the new storage medium. You can use the Beckhoff Service Tool (BST) for this purpose. BST is a graphical backup and restore program for PCs with a Windows operating system. You can create an image of your operating system and use it to back up the operating system. Then you can restore the created image to a new data carrier. The BST is available on a bootable BST USB flash drive. This includes Windows and a backup software. Select the size of the BST USB flash drive according to the size of the backup copy of your operating system. You can then keep the flash drive as a backup copy. For this purpose, the BST USB flash drives are designed for particularly long data preservation by means of special flash. For more information on the function of the BST, please refer to the corresponding [manual](#).

If your storage medium is defective and there is no backup, Beckhoff Service can provide you with a fresh Windows image. For this to be possible, the Beckhoff PC must already have been shipped with a valid operating system license. After installing the fresh image, the applications must be reinstalled.

Exchange MicroSD

Chapter 6.2 [Maintenance](#) |▶ 28| shows how to access the MicroSD.

To change the MicroSD, pull it out of the panel PC (see Fig. 18). Then reinsert the new MicroSD into the PC in the same orientation.

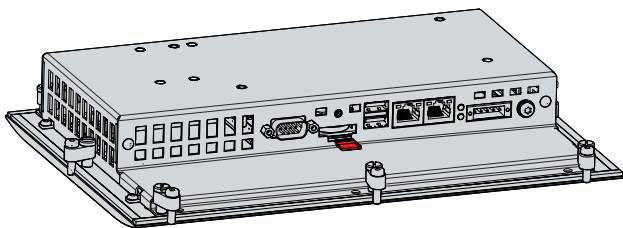

Fig. 19: CP6600_Replacing the storage medium

The old MicroSD must be disposed of in accordance with the national electronic scrap regulations.

7 Troubleshooting

Table 11: Troubleshooting

Fault	Cause	Measures
No function of the Panel PC	No power supply to the Panel PC Cable not connected	Check the power supply cable 1. Correctly connect the cable 2. Call Beckhoff Service
Panel PC boots, software starts, but controller does not work properly	The cause of the error is the software or plant parts outside of the Panel PC	Call the machine or software manufacturer
The Panel PC only works partially or only temporarily, e.g. dark image or none at all	Defective backlight in the display Components defective in the Panel PC	Call Beckhoff Service Call Beckhoff Service

8 Technical data

Table 12: Technical data

Product designation	CP6600-0001-0020		
Weight	1.4 kg		
Supply voltage	22-30 V _{DC} (24 V _{DC} power supply unit, NEC class 2)		
Power consumption	Data sheet for calculating power consumption and power loss at Downloadfinder: https://www.beckhoff.com/en-en/support/download-finder/search-result/?		
Protection rating	Front IP54, rear IP20		
Vibration resistance (sinusoidal vibration)	EN 60068-2-6:	10 ... 58 Hz:	0.035 mm
		58 ... 500 Hz:	0.5 G (~ 5 m/ s ²)
Shock resistance (shock)	EN 60068-2-27:	5 G (~ 50 m/ s ²), duration: 30 ms	
EMC interference immunity	conforms to EN 61000-6-2		
EMC interference emission	conforms to EN 61000-6-4		
Permissible ambient temperature	Operation: 0 °C ... +55 °C		
	Transport / storage: -20 °C ... +65 °C		
Permissible relative air humidity	Maximum 95%, no condensation		
Transport and storage	The same values for air humidity and shock resistance are to be observed during transport and storage as in operation. The shock resistance during transport can be improved by means of suitably packing the panel PC.		

9 Appendix

In the appendix you will find information for servicing and details of the approvals that your device has.

9.1 Service and support

Beckhoff and its worldwide branch offices offer comprehensive service and support, providing fast and competent assistance with all issues relating to Beckhoff products and system solutions.

Beckhoff Service

The Beckhoff Service Center supports you in all matters of after-sales service:

- on-site service
- repair service
- spare parts service
- hotline service

Hotline: + 49 5246/963-460

email: service@beckhoff.com

If your device requires service, please indicate the serial number, which you can find on the name plate.

Beckhoff Support

Support offers you comprehensive technical assistance, helping you not only with the application of individual Beckhoff products, but also with other, wide-ranging services:

- World-wide support
- Design, programming and commissioning of sophisticated automation systems
- extensive training program for Beckhoff system components

Hotline: + 49 5246/963-157

email: support@beckhoff.com

Headquarters

Beckhoff Automation GmbH & Co. KG
Hülshorstweg 20
33415 Verl
Germany

Phone: + 49 5246/963-0

email: info@beckhoff.de

The addresses of the worldwide Beckhoff branches and agencies can be found on our website at <http://www.beckhoff.com/>.

You will also find further documentation for Beckhoff components there.

9.2 Approvals

Your device has the following approvals:

- CE
- EAC
- UKCA
- FCC

You will find all other applicable approvals on the name plate of your device.

FCC approvals for the United States of America

FCC: Federal Communications Commission Radio Frequency Interference Statement

This device was tested and complies with the limits for a digital device of class A, according part 15 of the FCC regulations. These limits are designed to provide adequate protection against adverse interference, if the device is used in a commercial environment. This device generates, uses and may emit radio frequency energy and may cause adverse interference with radio communications, if it is not installed and used in accordance with the operating instructions. If this device is used in a residential area it is likely to cause adverse interference, in which case the user must take appropriate countermeasures in order to eliminate the interference at his own expense.

FCC approvals for Canada

FCC: Canadian Notice

This device does not exceed the class A limits for radiation, as specified by the Radio Interference Regulations of the Canadian Department of Communications.

List of figures

Fig. 1	CP6600_Push button extension.....	9
Fig. 2	CP6600_Structure.....	10
Fig. 3	CP6600_voltage socket pin numbering	11
Fig. 4	CP6600_Ethernet interface pin numbering	12
Fig. 5	CP6600_USB interface pin numbering	12
Fig. 6	CP6600_RS232 interface pin numbering.....	13
Fig. 7	CP6600_Status LEDs	14
Fig. 8	CP6600_name plate	15
Fig. 9	UPS function	17
Fig. 10	CP6600_dimensions	19
Fig. 11	CP6600_dimensions push button extension.....	19
Fig. 12	CP6600_control cabinet installation.....	20
Fig. 13	CP6600_Assembly of strain relief housing	22
Fig. 14	CP6600_Disassembly of strain relief housing.....	22
Fig. 15	CP6600_Grounding bolt for functional earthing	23
Fig. 16	CP6600_Removal from the control cabinet	27
Fig. 17	CP6600_Access to battery and storage medium.....	30
Fig. 18	CP6600_Replacing the battery	31
Fig. 19	CP6600_Replacing the storage medium	31

List of tables

Table 1	Key: C6600 structure	10
Table 2	Voltage socket pin assignment	11
Table 3	Ethernet interface pin assignment.....	12
Table 4	USB interface pin assignment.....	12
Table 5	RS232 pin assignment	13
Table 6	Meaning of the TC LED.....	14
Table 7	Meaning of the PWR LED	14
Table 8	Key: name plate CP6600	16
Table 9	Replacement recommendations for PC components.....	29
Table 10	Technical data of the battery	30
Table 11	Troubleshooting	32
Table 12	Technical data.....	33

More Information:
www.beckhoff.com/CP6600

Beckhoff Automation GmbH & Co. KG
Hülshorstweg 20
33415 Verl
Germany
Phone: +49 5246 9630
info@beckhoff.com
www.beckhoff.com

