

Original Handbuch für | DE

CB3067

Computerboard



Inhaltsverzeichnis

1	Ausgabestände der Dokumentation	5
2	Hinweise zur Dokumentation	6
3	Sicherheitshinweise	7
4	Übersicht	9
4.1	Eigenschaften	9
4.2	Featureliste	10
4.3	Spezifikationen und Dokumente	11
5	Detaillierte Beschreibung	12
5.1	Stromversorgung.....	12
5.2	Sekunden-USV	12
5.3	CPU.....	12
5.4	Speicher	12
6	Anschlüsse	13
6.1	Steckerübersicht	14
6.2	Power Input (P1300)	15
6.3	SATA-Schnittstellen (P500/1/2/3)	16
6.4	Serielle Schnittstelle COM2 intern (P1205).....	16
6.5	Lüfteranschlüsse (P1100)	17
6.6	GPIO (P504)	17
6.7	Display Port IPEX (P1001).....	18
6.8	LAN (P900/800)	19
6.9	USB3.0 extern (P1201/P1203).....	20
6.10	DVI-D (P1000).....	21
6.11	Serielle Schnittstelle COM1 (P1200).....	22
6.12	Speicher SO-DIMM260 (U601/U600)	23
6.13	USB 2.0 intern (P1202/P1204).....	27
6.14	Systemstecker (P1102).....	28
6.15	PCI-Express-Stecker (P1101).....	29
7	Status LEDs	31
7.1	RGB LED	31
8	BIOS-Einstellungen	32
8.1	Benutzung des Setups	32
8.2	Main	33
8.3	Advanced Menu	35
8.3.1	RC ACPI Settings.....	37
8.3.2	CPU Configuration	38
8.3.3	Trusted Computing.....	39
8.3.4	ACPI Settings Enabled.....	39
8.3.5	ACPI Settings Disabled.....	40
8.3.6	SCH3114 Super IO Configuration.....	41
8.3.7	Hardware Monitor.....	46
8.3.8	Serial Port Console Redirection	47

8.3.9	AMI Graphic Output Protocol Policy.....	52
8.3.10	PCI Subsystem Settings	53
8.3.11	USB Configuration	55
8.3.12	NVMe Configuration.....	56
8.3.13	Power Controller Options.....	57
8.3.14	SATA und RST Configuration	58
8.3.15	AMT Configuration	61
8.3.16	TLs Auth Configuration	65
8.3.17	Network Stack Configuration.....	68
8.3.18	Network Stack Configuration enabled.....	69
8.3.19	Intel Rapid Storage Technology.....	70
8.3.20	Intel I210 Gigabit Network Connection.....	71
8.3.21	Intel Ethernet Connection(2) I219-LM.....	73
8.3.22	Driver Health	75
8.4	Chipset.....	76
8.4.1	System Agent (SA) Configuration	77
8.4.2	PCH-IO Configuration	79
8.5	Security	85
8.5.1	Secure Boot	86
8.6	Boot.....	101
8.6.1	Fixed Boot Order Parameters	102
8.7	Save & Exit.....	103
8.8	BIOS-Update.....	104
9	Mechanische Zeichnung	105
9.1	Leiterplatte: Outlines	105
9.2	Leiterplatte: Bohrungen	106
9.3	Leiterplatte: Pin-1-Abstände.....	107
9.4	Leiterplatte: Heat Sink.....	108
10	Technische Daten	110
10.1	Elektrische Daten	110
10.2	Umgebungsbedingungen	110
10.3	Thermische Spezifikationen	111
11	Support und Service	112
12	Anhang I: Post-Codes.....	113
13	Anhang II: Ressourcen	114
13.1	Interrupt.....	114
13.2	PCI-Devices	115
13.3	SMB-Devices	116

1 Ausgabestände der Dokumentation

Version	Änderungen
0.1	Erste Vorabversion, G0
1.0	Erstes Release G2 mit aktuellem BIOS 0.13 und neuem Titelblatt
1.1	G2, BIOS Version a.020 eingefügt
1.2	Informationen zu Echtzeitanwendungen hinzugefügt

Alle in diesem Handbuch erwähnten Firmennamen und Produktbezeichnungen sind als eingetragene oder nicht eingetragene Marken Eigentum ihrer jeweiligen Inhaber und als solche national und international markenrechtlich geschützt.

2 Hinweise zur Dokumentation

Diese Beschreibung wendet sich ausschließlich an ausgebildetes Fachpersonal der Steuerungs- und Automatisierungstechnik, das mit den geltenden nationalen Normen vertraut ist.

Zur Installation und Inbetriebnahme der Komponenten ist die Beachtung der Dokumentation und der nachfolgenden Hinweise und Erklärungen unbedingt notwendig.

Das Fachpersonal ist verpflichtet, für jede Installation und Inbetriebnahme die zu dem betreffenden Zeitpunkt veröffentlichte Dokumentation zu verwenden.

Das Fachpersonal hat sicherzustellen, dass die Anwendung bzw. der Einsatz der beschriebenen Produkte alle Sicherheitsanforderungen, einschließlich sämtlicher anwendbaren Gesetze, Vorschriften, Bestimmungen und Normen erfüllt.

Dokumentenursprung

Diese Dokumentation ist in deutscher Sprache verfasst. Alle weiteren Sprachen werden vom deutschen Original abgeleitet.

Disclaimer

Diese Dokumentation wurde sorgfältig erstellt. Die beschriebenen Produkte werden jedoch ständig weiter entwickelt.

Wir behalten uns das Recht vor, die Dokumentation jederzeit und ohne Ankündigung zu überarbeiten und zu ändern.

Aus den Angaben, Abbildungen und Beschreibungen in dieser Dokumentation können keine Ansprüche auf Änderung bereits gelieferter Produkte geltend gemacht werden.

Marken

Beckhoff®, TwinCAT®, TwinCAT/BSD®, TC/BSD®, EtherCAT®, EtherCAT G®, EtherCAT G10®, EtherCAT P®, Safety over EtherCAT®, TwinSAFE®, XFC®, XTS® und XPlanar® sind eingetragene und lizenzierte Marken der Beckhoff Automation GmbH.

Die Verwendung anderer in dieser Dokumentation enthaltenen Marken oder Kennzeichen durch Dritte kann zu einer Verletzung von Rechten der Inhaber der entsprechenden Bezeichnungen führen.

Patente

Die EtherCAT-Technologie ist patentrechtlich geschützt, insbesondere durch folgende Anmeldungen und Patente:

EP1590927, EP1789857, EP1456722, EP2137893, DE102015105702

mit den entsprechenden Anmeldungen und Eintragungen in verschiedenen anderen Ländern.



EtherCAT® ist eine eingetragene Marke und patentierte Technologie lizenziert durch die Beckhoff Automation GmbH, Deutschland

Copyright

© Beckhoff Automation GmbH & Co. KG, Deutschland.

Weitergabe sowie Vervielfältigung dieses Dokuments, Verwertung und Mitteilung seines Inhalts sind verboten, soweit nicht ausdrücklich gestattet.

Zuwendungen verpflichten zu Schadenersatz. Alle Rechte für den Fall der Patent-, Gebrauchsmuster- oder Geschmacksmustereintragung vorbehalten.

3 Sicherheitshinweise

Sicherheitsbestimmungen

Beachten Sie die folgenden Sicherheitshinweise und Erklärungen!

Produktspezifische Sicherheitshinweise finden Sie auf den folgenden Seiten oder in den Bereichen Montage, Verdrahtung, Inbetriebnahme usw.

Haftungsausschluss

Die gesamten Komponenten werden je nach Anwendungsbestimmungen in bestimmten Hard- und Software-Konfigurationen ausgeliefert. Änderungen der Hard- oder Software-Konfiguration, die über die dokumentierten Möglichkeiten hinausgehen, sind unzulässig und bewirken den Haftungsausschluss der Beckhoff Automation GmbH & Co. KG.

Qualifikation des Personals

Diese Beschreibung wendet sich ausschließlich an ausgebildetes Fachpersonal der Steuerungs-, Automatisierungs- und Antriebstechnik, das mit den geltenden Normen vertraut ist.

Erklärung der Symbole

In der vorliegenden Dokumentation werden die folgenden Symbole mit einem nebenstehenden Sicherheitshinweis oder Hinweistext verwendet. Die Sicherheitshinweise sind aufmerksam zu lesen und unbedingt zu befolgen!

GEFAHR

Akute Verletzungsgefahr!

Wenn der Sicherheitshinweis neben diesem Symbol nicht beachtet wird, besteht unmittelbare Gefahr für Leben und Gesundheit von Personen!

WARNUNG

Verletzungsgefahr!

Wenn der Sicherheitshinweis neben diesem Symbol nicht beachtet wird, besteht Gefahr für Leben und Gesundheit von Personen!

VORSICHT

Schädigung von Personen!

Wenn der Sicherheitshinweis neben diesem Symbol nicht beachtet wird, können Personen geschädigt werden!

HINWEIS

Schädigung von Umwelt oder Geräten

Wenn der Hinweis neben diesem Symbol nicht beachtet wird, können Umwelt oder Geräte geschädigt werden.

Tipp oder Fingerzeig



Dieses Symbol kennzeichnet Informationen, die zum besseren Verständnis beitragen.

UL-Hinweis



Dieses Symbol kennzeichnet wichtige Informationen bezüglich der UL-Zulassung.

Bestimmungsgemäße Verwendung

Das Computerboard CB3067 wurde ausschließlich für die Konfiguration in Automatisierungsprozessen konstruiert und entwickelt. Dazu ist das Board mit externen Schnittstellen ausgestattet, um digitale oder analoge Signale aufzunehmen oder auszugeben oder an übergeordnete Komponenten weiterzuleiten.

Jegliche davon abweichende Verwendung gilt als nicht bestimmungsgemäß.

Die angegebenen Grenzwerte für elektrische- und technische Daten müssen eingehalten werden.

4 Übersicht

4.1 Eigenschaften

Das CB3067 ist ein hochkomplexes 3,5-Zoll-Board. Es basiert auf Intel®'s Coffee-Lake S-Prozessoren der Core™, Celeron™ und Pentium-Familie in Verbindung mit dem Q370-Chipsatz.

Modernste energiesparende DDR4-Technologie ermöglicht einen Speicherausbau von bis zu 64 GByte (DDR4-2666) über SO-DIMM260. Neben einem PCI-Express-Bus steht weitere Peripherie zur Verfügung, wie z.B. HDMI oder DisplayPort via I-PEX, 4x SATA mit bis zu 6 Gbit/s, DVI/HDMI, 11x USB (davon 5x USB3.0), 2x Gbit-LAN und eine externe und eine interne serielle Schnittstelle.

Die Eingangsspannung ist 5 V.



Abb. 1: CB3067 Blockschaltbild

4.2 Featureliste

CB3067	3,5“-Board
CPU	Intel® Core™ i3/Core™ i5/Core™ i7 Intel® Pentium® Intel® Celeron®
Chipsatz	Intel® Q370-PCH
Speicher	2x SO-DIMM260 1.2 V DDR4-2666 Maximaler Speicherausbau 64 GB
I/O Extern	1x DVI-D (DVI oder HDMI 1.4) 2 x GBit-LAN, Intel® i219 und i210 4x USB3.0 1 x COM A
I/O Intern	1x I-PEX (HDMI1.4 oder DP1.2 und USB3.0) 4x SATA 3.0, RAID 0/1/5/10 1x PCIe Gen3 (1x PCIe x4 oder 4x PCIe x1) 6x USB2.0 8 x GPIO 1 x COM B
Grafikauflösung	DisplayPort: 4096x2304@60 Hz HDMI1.4: 4096x2304@60 Hz 4096x2160@24 Hz DVI: 1920x1200@60 Hz
RTC	Externe CMOS-Batterie
BIOS	AMI® Aptio V
Stromversorgung	5 V/S5 V/3,3 V/12 V
Format	102 x 147 mm

● Verfügbarkeit der Prozessoren

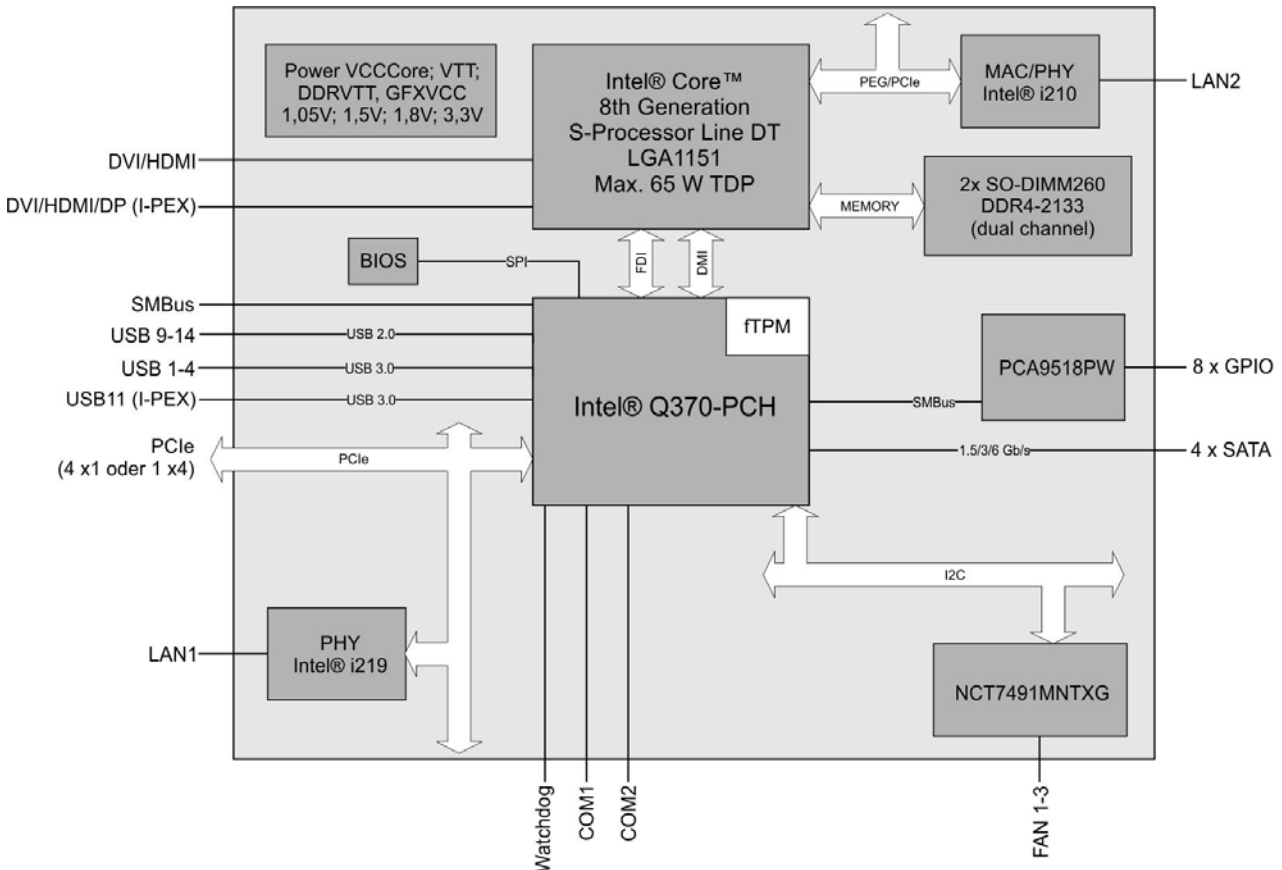
i Die Featureliste führt alle bestellbaren Prozessoren auf. Ihre tatsächliche Verfügbarkeit ist herstellerabhängig.

4.3 Spezifikationen und Dokumente

Für die Erstellung dieses Handbuchs bzw. als weiterführende technische Dokumentation wurden die folgenden Dokumente, Spezifikationen oder Internetseiten in der verwendet.

- **PCI-Spezifikation**
 - Version 2.3 bzw. 3.0
 - www.pcisig.com
- **PCI Express® Base Specification**
 - Version 5.0
 - www.pcisig.com
- **ACPI-Spezifikation**
 - Version 5.0
 - www.acpi.info
- **ATA/ATAPI-Spezifikation**
 - Version 7 Rev. 1
 - www.t13.org
- **USB-Spezifikationen**
 - www.usb.org
- **SM-Bus-Spezifikation**
 - Version 2.0
 - www.smbus.org
- **Intel®-Chipbeschreibungen**
 - Intel® Core™ Processor Product Family datasheet
 - www.intel.com
- **Intel®-Chipbeschreibung**
 - I219 Datasheet
 - i210 Datasheet
 - www.intel.com
- **SMSC®-Chipbeschreibung**
 - SCH3114 Datasheet (NDA erforderlich)
 - www.smsc.com
- **American Megatrends®**
 - Aptio™ Text Setup Environment (TSE) User Manual
 - www.ami.com
- **American Megatrends®**
 - Aptio™ 5.x Status Codes
 - www.ami.com

5 Detaillierte Beschreibung

5.1 Stromversorgung

Der Anschluss für die Stromversorgung des CB3067 ist als 2x10-poliger Gehäusestecker realisiert.

Die 12 V-Versorgung wird für den Betrieb von PCI-Express-Karten und für die Lüfteranschlüsse benötigt. COM RXD und TXD können auch für ein eigenes Netzteil z.B. für die USV-Funktion genutzt werden.

Die Kommunikation erfolgt über SMBus (SMB-CLK/SMB-DAT).

HINWEIS

Nur Beckhoff-zertifiziertes Netzteil verwenden!

Das CB3067 ist ausschließlich für den Betrieb mit dem Beckhoff-Netzteil CA2000-0026 vorgesehen, da nur damit die 3,3 V-Versorgung gewährleistet ist.

5.2 Sekunden-USV

Optional kann das CB3067 mit einer steckbaren Sekunden-USV ausgestattet werden, die die Stromversorgung abhängig von ihrer Kapazität und dem Stromverbrauch des Boards einige Sekunden aufrecht halten kann, um kurze Stromausfälle oder Spannungsschwankungen zu kompensieren. Die Größe der Kapazität ist maximal durch den Platzbedarf beschränkt.

HINWEIS

Akku und SUSV nicht gleichzeitig benutzen!

Das CB3067 kann entweder mit einem Akku oder einem SUSV-Modul betrieben werden. Um im Fall einer Spannungsunterbrechung Datenverlust zu vermeiden, dürfen die beiden Komponenten nicht gleichzeitig verwendet werden!

5.3 CPU

Bei den eingesetzten Prozessoren handelt es sich um die 8. und 9. Generation von Intel®'s Coffee-Lake S-CPU's der Core™-, Pentium™- und Celeron™-Familie. Die Prozessoren beider Generationen zeichnen sich durch eine sehr niedrige Leistungsaufnahme aus und bieten dabei eine zeitgemäße Performance mit Taktraten von derzeit bis zu 4,4 GHz.

Die eingesetzten Intel®-Prozessoren der Coffee-Lake-Familie verfügen über einen erweiterten Umgebungstemperaturbereich und sind deshalb besonders für den Einsatz in industriellen Systemen geeignet.

5.4 Speicher

Auf dem CB3067-Board kommen SO-DIMM260-Speichermodule (DDR4-2666), wie sie in Notebooks üblich sind, zum Einsatz. Aus technischen und mechanischen Gründen ist es möglich, dass bestimmte Speichermodule nicht eingesetzt werden können. Informieren Sie sich bei Ihrem Distributor über die empfohlenen Speichermodule.

Mit den derzeit erhältlichen SO-DIMM260-Modulen ist je nach Produktvariante ein Speicherausbau bis 32GB möglich.

● Bestückung beider Speichersockel

i Achten Sie bei der Bestückung beider Speichersockel darauf, dass Sie gleiche Speichermodule einsetzen.

6 Anschlüsse

Auf den folgenden Seiten werden sämtliche Steckverbinder auf dem CB3067 beschrieben.

● **Anforderung an die Verkabelung!**

i Die verwendeten Kabel müssen für die meisten Schnittstellen bestimmten Anforderungen genügen. Für eine zuverlässige USB-2.0-Verbindung sind beispielsweise verdrehte und geschirmte Kabel notwendig. Einschränkungen bei der maximalen Kabellänge sind auch nicht selten. Sämtliche dieser schnittstellenspezifischen Erfordernisse entnehmen Sie den jeweiligen Spezifikationen und beachten diese entsprechend.

6.1 Steckerübersicht

Die folgende Abbildung stellt die Steckeranschlüsse auf der Bestückungsseite des CB3067-Boards dar. Der Tabelle darunter entnehmen Sie die Funktion des jeweiligen Steckers. Die aufgeführte Handbuchseite, gibt Ihnen weitergehende Informationen zu diesem Anschluss. Die Beschreibung der Schnittstellen erfolgt im Uhrzeigersinn, beginnend bei Power Input (P1300).



Abb. 2: CB3067-Steckerübersicht

Nummer	Funktion (Bezeichnung)	Seite
P1300	Power Input	Power Input (P1300) [▶ 15]
P500/1/2/3	SATA-Schnittstellen	SATA-Schnittstellen (P500/1/2/3) [▶ 16]
P1205	Serielle Schnittstelle, intern	Serielle Schnittstelle COM2 intern (P1205) [▶ 16]
P1100	Lüfteranschluss, intern	Lüfteranschlüsse (P1100) [▶ 17]
P504	GPIO	GPIO (P504) [▶ 17]
P1001	Display Port IPEX	Display Port IPEX (P1001) [▶ 18]
P800/900	1Gbit LAN	LAN (P900/800) [▶ 19]
P1201/1203	USB 3.0	USB3.0 extern (P1201/P1203) [▶ 20]
P1000	DVI-D	DVI-D (P1000) [▶ 21]
P1200	COM A, extern	Serielle Schnittstelle COM1 (P1200) [▶ 22]
U600/601	2 x SODIMM 260 DDR4	Speicher SO-DIMM260 (U601/U600) [▶ 23]
P1202	2 x USB 2.0, intern	USB 2.0 intern (P1202/P1204) [▶ 27]
P1204	4 x USB 2.0, intern	USB 2.0 intern (P1202/P1204) [▶ 27]
P1102	System, intern	Systemstecker (P1102) [▶ 28]
P1101	PCIe x4	PCI-Express-Stecker (P1101) [▶ 29]

6.2 Power Input (P1300)

Der Anschluss für die Stromversorgung des CB3067 ist als 2x10-poliger Gehäusestecker realisiert.

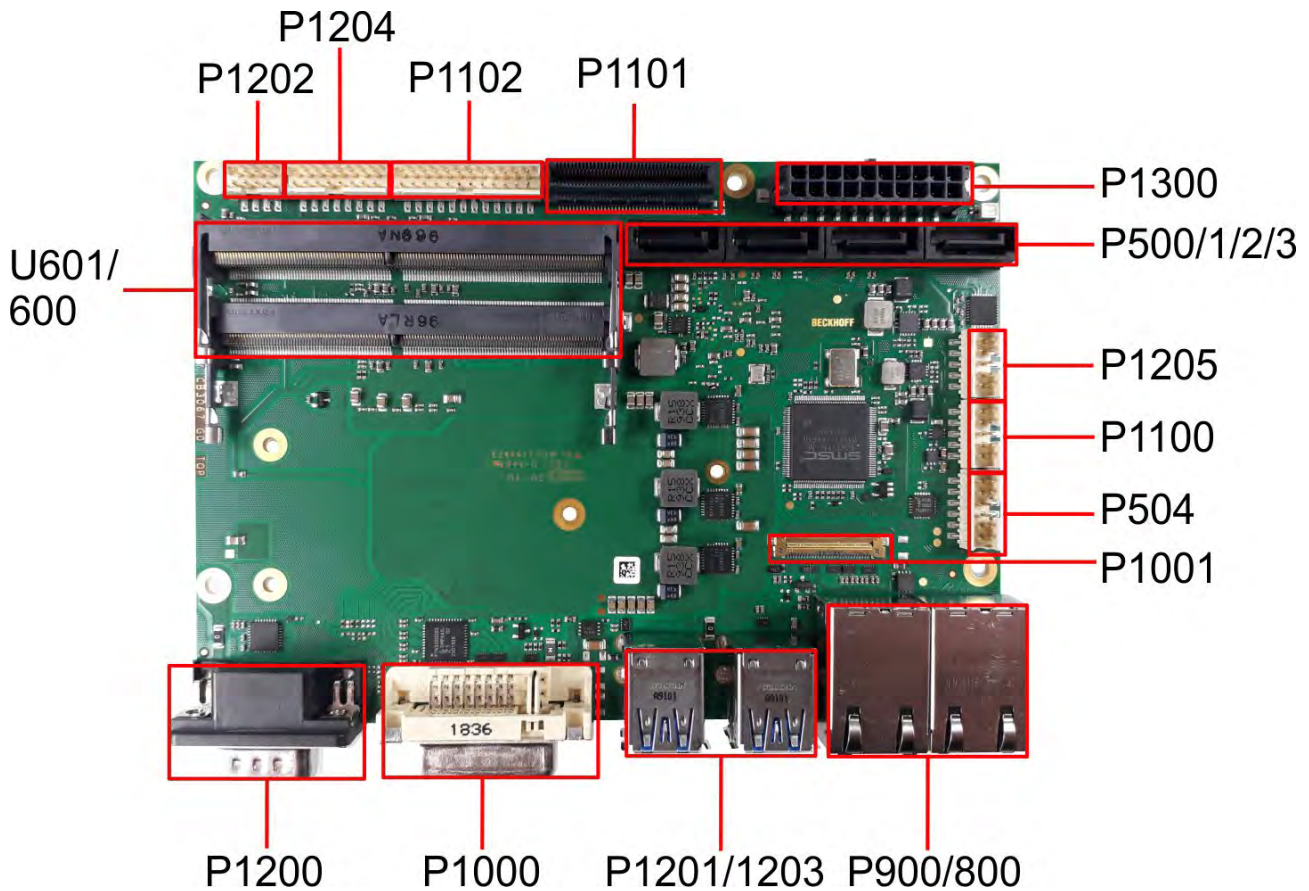
Die 12 V-Versorgung wird für den Betrieb von PCI-Express-Karten und für die Lüfteranschlüsse benötigt. COM RXD und TXD können auch für ein eigenes Netzteil z.B. für die USV-Funktion genutzt werden.

Die Kommunikation erfolgt über SMBus (SMB-CLK/SMB-DAT).



Abb. 3: CB3067-Power Input (P1300)

Pinbelegung Power Input					
Beschreibung	Name	Pin		Name	Beschreibung
SMBus Clock-Signal/ COM Transmit Daten	SMB_CLK COM.TXD	1	11	SMB_DAT/ COM.RXD	SMBus Daten/ COM Receive Daten
'Power Supply On'-Eingang zum Einschalten der Ausgangsspannungen: Low(0 V) = Spannungen einschalten High(5 V oder offener (Kontakt) = Spannungen ausschalten	PS_ON	2	12	ATX PWRGOOD	'ATX Powergood'-Ausgang meldet dem PC, dass alle Spannungen eingeschaltet sind: Low(0 V) = Spannung nicht ok Open Drain = Spannung ok
Powerbutton-Ausgang zum Ein- und Ausschalten des angeschlossenen PC	ATX PWRBTN#	3	13	SVCC	Versorgungsspannung S5 V
Versorgungsspannung 12 V	12V	4	14	12V	Versorgungsspannung 12 V
Masse	GND	5	15	GND	Masse
Masse	GND	6	16	GND	Masse
Versorgungsspannung 5 V	VCC	7	17	VCC	Versorgungsspannung 5 V
Versorgungsspannung 5 V	VCC	8	18	VCC	Versorgungsspannung 5 V
SUSV Aktiv-Ausgang: Low (0 V) = SUSV inaktiv High (3,3 V) = SUSV aktiv	SUSV	9	19	GND	Masse
Versorgungsspannung 3,3 V	3,3V	10	20	3,3V	Versorgungsspannung 3,3 V

6.3 SATA-Schnittstellen (P500/1/2/3)

Das CB3067-Board ist mit vier SATA-Schnittstellen ausgestattet, die eine Übertragungsrate von bis zu 6Gbit pro Sekunde erlauben. Die Schnittstellen stehen als 7-polige Standard-SATA-Stecker zur Verfügung. Es werden RAID 0/1/5/10 unterstützt.

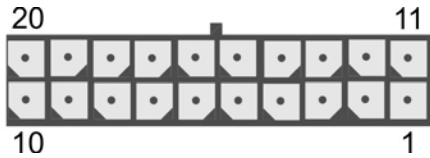
Die notwendigen Einstellungen werden über das BIOS-Setup vorgenommen.



Abb. 4: CB3067-SATA (P500/1/2/3)

Pinbelegung SATA-Schnittstellen		
Pin	Name	Beschreibung
1	GND	Masse
2	SATATX	SATA Senden +
3	SATATX#	SATA Senden -
4	GND	Masse
5	SATARX#	SATA Empfangen -
6	SATARX	SATA Empfangen +
7	GND	Masse

6.4 Serielle Schnittstelle COM2 intern (P1205)

Die interne serielle Schnittstelle COM2 wird mit einem 2x5-poliger Wannenstecker realisiert. Die Signale stehen nach RS232-Norm zur Verfügung.



Abb. 5: CB3067-COM2 intern (P1205)

Pinbelegung COM2 intern					
Beschreibung	Name	Pin		Name	Beschreibung
Data Carrier Detect	DCD	1	6	DSR	Data Set Ready
Receive Data	RXD	2	7	RTS	Request to Send
Transmit Data	TXD	3	8	CTS	Clear to Send
Data Terminal Ready	DTR	4	9	RI	Ring Indicator
Masse	GND	5	10	VCC	Versorgungsspannung 3,3 V

6.5 Lüfteranschlüsse (P1100)

An die Baugruppe können drei Lüfter mit einer Versorgungsspannung von 12 Volt angeschlossen werden. Dies geschieht über einen 2x5-poligen Wannenstecker. Signale für die Überwachung der Lüfterdrehzahl sind ebenfalls vorhanden.

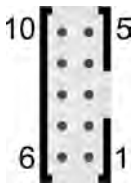

Abb. 6: CB3067-Lüfter (P1100)

Pinbelegung Lüfteranschluss					
Beschreibung	Name	Pin		Name	Beschreibung
Masse geschaltet Lüfter 1	FANON1	1	6	FANON2	Masse geschaltet Lüfter 2
Versorgungsspannung 12 V	12V	2	7	12V	Versorgungsspannung 12 V
Überwachung Lüfter 1	FANCTRL1	3	8	FANCTRL2	Überwachung Lüfter 2
Versorgungsspannung 12 V	12V	4	9	FANCTRL3	Überwachung Lüfter 3
Masse geschaltet Lüfter 3	FANON3	5	10	GND	Masse

6.6 GPIO (P504)

Das Board verfügt über eine General Purpose Input/Output-Schnittstelle, die über einen 2x6-poligen Wannenstecker herausgeführt ist. Durch entsprechende Programmierung des zugehörigen Chips (PCA9535BS) können hier in sehr flexibler Weise I/O-Funktionen angelegt werden. Erkundigen Sie sich bei Ihrem Distributor nach entsprechender Software-Unterstützung

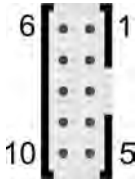

Abb. 7: CB3067-GPIO (P504)

Pinbelegung GPIO					
Beschreibung	Name	Pin		Name	Beschreibung
Versorgungsspannung 5 V	VCC	1	7	VCC	Versorgungsspannung 5 V
GP Input/Output1	GPIO0	2	8	GPIO4	GP Input/Output5
GP Input/Output2	GPIO1	3	9	GPIO5	GP Input/Output6
GP Input/Output3	GPIO2	4	10	GPIO6	GP Input/Output7
GP Input/Output4	GPIO3	5	11	GPIO7	GP Input/Output8
Masse	GND	6	12	GND	Masse

6.7 Display Port IPEX (P1001)

Das CB3067 verfügt noch über einen weiteren DVI-Anschluss, der als 30-poliger Flachkabelstecker realisiert ist. Analoge VGA-Signale liegen an diesem Anschluss nicht an, es kann aber ein HDMI- oder DisplayPort-Bildschirm angeschlossen werden. Außerdem wird über diesen Stecker ein weiterer USB-Kanal herausgeführt. Dieser USB-Kanal unterstützt die Spezifikation 3.0. Er liefert bis zu 900mA Strom und ist elektronisch abgesichert.

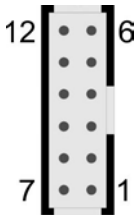
Beachten Sie bei der Verkabelung, Receive-Leitungen mit Transmit-Leitungen und umgekehrt zu verbinden. Der über VCC entnommene Strom darf in der Summe 2 A (0,5 A pro Kontakt) nicht übersteigen, für 3,3 V ist der maximale Strom 1 A (0,5 A pro Kontakt).

HINWEIS

IPEX-Kabel verwenden!

Verwenden für diese Schnittstelle ein spezielles I-PEX-Kabel.



Abb. 8: CB3067-Display Port IPEX (P1001)

Pinbelegung Display Port IPEX		
Pin	Name	Beschreibung
1	TMDS0#/DP2#	DVI Data 0 -/DP Lane 2 -
2	TMDS0/DP2	DVI Data 0 +/DP Lane 2 +
3	TMDS1#/DP1#	DVI Data 1 -/DP Lane 1 -
4	TMDS1/DP1	DVI Data 1 +/DP Lane 1 +
5	TMDS2#/DP0#	DVI Data 2 -/DP Lane 0 -
6	TMDS2/DP0	DVI Data 2 +/DP Lane 0 +
7	TMDSCLK#/DP3#	DVI Clock -/DP Lane 3 -
8	TMDSCLK/DP3	DVI Clock +/DP Lane 3 +
9	N/C	Nicht verbunden
10	SEL_DVI/DP#	DVI-DisplayPort Select
11	DDCK/DPAUX	EDID Clock/DP Aux +
12	DDDA/DPAUX#	EDID Data/DP Aux -
13	VCC	Versorgungsspannung 5 V
14	GND	Masse
15	HPD	Hot Plug Detect
16	USBVCC	USB-Versorgung 5 V
17	USBVCC	USB-Versorgung 5 V
18	N/C	Nicht verbunden
19	N/C	Nicht verbunden
20	SSRX-	SuperSpeed Receive -
21	SSRX+	SuperSpeed Receive +
22	USB-	USB Minus-Datenkanal
23	USB+	USB Plus-Datenkanal
24	SSTX-	SuperSpeed Transmit-
25	SSTX+	SuperSpeed Transmit+
26	3.3V	Versorgungsspannung 3,3 V
27	3.3V	Versorgungsspannung 3,3 V
28	VCC	Versorgungsspannung 5 V
29	VCC	Versorgungsspannung 5 V
30	VCC	Versorgungsspannung 5 V

6.8 LAN (P900/800)

Das Board verfügt über zwei Gigabit-LAN-Anschlüsse. An beiden können 10BaseT-, 100BaseT- und 1000BaseT-kompatible Netzwerkkomponenten angeschlossen werden. Die erforderliche Geschwindigkeit wird automatisch gewählt. Auto-Cross und Auto-Negotiate stehen ebenso zur Verfügung wie PXE- und WOL-Funktionalität. Controller sind Intel®'s i219 (PHY, LAN1) und i210 (MAC/PHY, LAN2).



Abb. 9: CB3067-LAN (P900-800)

● Echtzeitanwendungen

i

Der über PCIe angebundene Ethernet-Port ist in der Regel für Zyklus-Zeiten $\leq 1\text{ms}$ und für Distributed-Clock-Anwendungen bei EtherCAT geeignet.

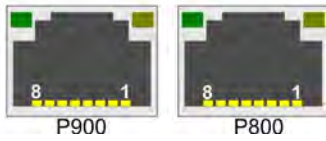
Der im Chipsatz integrierte Ethernet-Port ist in der Regel für Real-Time-Ethernet-Anwendungen mit Zyklus-Zeiten $> 1\text{ms}$ (ohne Distributed-Clocks) geeignet.

Pinbelegung LAN					
Beschreibung	Name	Pin		Name	Beschreibung
LED LAN LINK/ACT	LINKACT 1	1	7	SPEED1000	LED LAN 1000MB
LAN Leitung 1 Plus	LAN11+	2	8	LAN10+	LAN Leitung 0 Plus
LAN Leitung 1 Minus	LAN11-	3	9	LAN10-	LAN Leitung 0 Minus
LAN Leitung 3 Plus	LAN13+	4	10	LAN12+	LAN Leitung 2 Plus
LAN Leitung 3 Minus	LAN13-	5	11	LAN12-	LAN Leitung 2 Minus
LED LAN 100MB	SPEED100	6	12	S3,3V	Standby-Versorgungsspannung 3,3 V

6.9 USB3.0 extern (P1201/P1203)

Die USB3.0-Kanäle 1 bis 4 sind in Form von Standard-USB-Steckern herausgeführt.

Die USB-Kanäle unterstützen die USB-Spezifikation 3.0. Durch das BIOS können alle notwendigen Einstellungen für USB durchgeführt werden.

HINWEIS

Funktionalität von USB-Maus und Tastatur

Beachten Sie, dass die Funktionalität „USB-Maus und Tastatur“ des BIOS-Setup nur benötigt wird, wenn das Betriebssystem keine USB-Unterstützung bietet. Für Einstellungen im Setup und zum Booten von Windows mit einer angeschlossenen USB-Maus und Tastatur wählen Sie diese Funktion nicht, weil dies zu erheblichen Leistungseinschränkungen führt

Die einzelnen USB-Schnittstellen können bis zu 900 mA Strom liefern und sind elektronisch abgesichert.



Abb. 10: CB3067-USB3.0 (P1201+1203)

Pinbelegung USB3.0		
Pin	Name	Bechreibung
1	VCC	5 V für USBX
2	USBX#	Minus-Datenkanal USBX
3	USBX	Plus-Datenkanal USBX
4	GND	Masse
5	StdA_SSRX-	SuperSpeed Receiver -
6	StdA_SSRX+	SuperSpeed Receiver +
7	GND	Masse
8	StdA_SSTX-	SuperSpeed Transmitter -
9	StdA_SSTX+	SuperSpeed Transmitter +

6.10 DVI-D (P1000)

Das Board verfügt über einen DVI-D-Anschluss für DVI-fähige Displays. Analogdisplays können nicht angeschlossen werden.

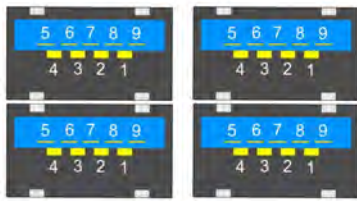

Abb. 11: CB3067-DVI-D (P1000)

Pinbelegung DVI-D		
Pin	Name	Beschreibung
1	TMDSDAT2#	DVI-Daten 2 -
2	TMDSDAT2	DVI-Daten 2 +
3	GND	Masse
4	N/C	Nicht verbunden
5	N/C	Nicht verbunden
6	DDCCLK	DDC Clock (DVI/VGA)
7	DDCDAT	DDC Data (DVI/VGA)
8	N/C	Nicht verbunden
9	TMDSDAT1#	DVI-Daten 1 -
10	TMDSDAT1	DVI-Daten 1 +
11	GND	Masse
12	N/C	Nicht verbunden
13	N/C	Nicht verbunden
14	VCC	Versorgungsspannung 5V
15	GND	Masse
16	HP_DETECT	Hot Plug Detect
17	TMDSDAT0#	DVI-Daten 0 -
18	TMDSDAT0	DVI-Daten 0 +
19	GND	Masse
20	N/C	Nicht verbunden
21	N/C	Nicht verbunden
22	GND	Masse
23	TMDSCLK	DVI-Clock
24	TMDSCLK#	DVI-Clock

6.11 Serielle Schnittstelle COM1 (P1200)

Die serielle Schnittstelle COM1 ist über einen 9-poligen Standard-DSUB-Stecker (male) herausgeführt. Die Signale stehen nach RS232-Norm zur Verfügung.

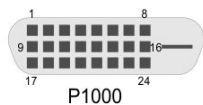
Die Port-Adresse und der benutzte Interrupt werden mit Hilfe des BIOS-Setup eingestellt.



Abb. 12: CB3067-COM1 (P1200)

Pinbelegung COM1					
Beschreibung	Name	Pin		Name	Beschreibung
Data Carrier Detect	DCD	1	6	DSR	Data Set Ready
Receive Data	RXD	2	7	RTS	Request to Send
Transmit Data	TXD	3	8	CTS	Clear to Send
Data Terminal Ready	DTR	4	9	RI	Ring Indicator
Masse	GND	5			

6.12 Speicher SO-DIMM260 (U601/U600)

Auf dem CB3067-Board befinden sich zwei SO-DIMM260-Speichersteckplätze für DDR4-2666-RAM. Aus technischen und mechanischen Gründen ist es möglich, dass bestimmte Speichermodule nicht eingesetzt werden können. Informieren Sie sich bei Ihrem Distributor über die empfohlenen Speichermodule.

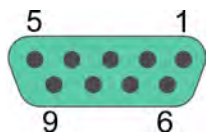
Bei zwei Steckplätzen ist mit derzeit erhältlichen Modulen ein Speicherausbau bis 64 GByte möglich. Achten Sie bei der Bestückung beider Speichersockel auf den Einsatz identischer Speichermodule.

Alle Timingparameter für die unterschiedlichen Fabrikate und Ausbaustufen werden durch das BIOS automatisch eingestellt.



Abb. 13: CB3067-SO-DIMM260 (U601/U600)

Pinbelegung SO-DIMM260					
Beschreibung	Name	Pin		Name	Beschreibung
Masse	GND	1	2	GND	Masse
Datenleitung 5	DQ5	3	4	DQ4	Datenleitung 4
Masse	GND	5	6	GND	Masse
Datenleitung 1	DQ1	7	8	DQ0	Datenleitung 0
Masse	GND	9	10	GND	Masse
Data Strobe 0 -	DQS0#	11	12	NC	Nicht verbunden
Data Strobe 0 +	DQS0	13	14	GND	Masse
Masse	GND	15	16	DQ6	Datenleitung 6
Datenleitung 7	DQ7	17	18	GND	Masse
Masse	GND	19	20	DQ2	Datenleitung 2
Datenleitung 3	DQ3	21	22	GND	Masse
Masse	GND	23	24	DQ12	Datenleitung 12
Datenleitung 13	DQ13	25	26	GND	Masse
Masse	GND	27	28	DQ8	Datenleitung 8
Datenleitung 9	DQ9	29	30	GND	Masse
Masse	GND	31	32	DQS1#	Data Strobe 1 -
Data Mask 1	DQM1	33	34	DQS1	Data Strobe 1 +
Masse	GND	35	36	GND	Masse
Datenleitung 15	DQ15	37	38	DQ14	Datenleitung 14
Masse	GND	39	40	GND	Masse
Datenleitung 10	DQ10	41	42	DQ11	Datenleitung 11
Masse	GND	43	44	GND	Masse
Datenleitung 21	DQ21	45	46	DQ20	Datenleitung 20
Masse	GND	47	48	GND	Masse
Datenleitung 17	DQ17	49	50	DQ16	Datenleitung 16
Masse	GND	51	52	GND	Masse
Data Strobe 2 -	DQS2#	53	54	DQM2	Data Mask 2
Data Strobe 2 +	DQS2	55	56	GND	Masse
Masse	GND	57	58	DQ22	Datenleitung 22
Datenleitung 23	DQ23	59	60	GND	Masse
Masse	GND	61	62	DQ18	Datenleitung 18
Datenleitung 19	DQ19	63	64	GND	Masse
Masse	GND	65	66	DQ28	Datenleitung 28
Datenleitung 29	DQ29	67	68	GND	Masse
Masse	GND	69	70	DQ24	Datenleitung 24
Datenleitung 25	DQ25	71	72	GND	Masse
Masse	GND	73	74	DQS3#	Data Strobe 3 -
Data Mask 3	DQM3	75	76	DQS3	Data Strobe 3 +
Masse	GND	77	78	GND	Masse
Datenleitung 30	DQ30	79	80	DQ31	Datenleitung 31
Masse	GND	81	82	GND	Masse
Datenleitung 26	DQ26	83	84	DQ27	Datenleitung 27
Masse	GND	85	86	GND	Masse
Nicht verbunden	CB5/NC	87	88	CB4/NC	Nicht verbunden
Masse	GND	89	90	GND	Masse
Nicht verbunden	CB1/NC	91	92	CB0/NC	Nicht verbunden
Masse	GND	93	94	GND	Masse

Pinbelegung SO-DIMM260					
Beschreibung	Name	Pin		Name	Beschreibung
Data Strobe 8 -	DQS8#	95	96	DQM8	Data Mask 8
Data Strobe 8 +	DQS8	97	98	GND	Masse
Masse	GND	99	100	CB6/NC	Nicht verbunden
Nicht verbunden	CB2/NC	101	102	GND	Masse
Masse	GND	103	104	CB7/NC	Nicht verbunden
Nicht verbunden	CB3/NC	105	106	GND	Masse
Masse	GND	107	108	RESET_n	Reset
Clock Enable 0	CKE0	109	110	CKE1	Clock Enable 1
Versorgungsspannung 1,2 V	VCC	111	112	VCC	Versorgungsspannung 1,2 V
Bank Group Input 1	BG1	113	114	ACT_n	Activation Command Input
Bank Group Input 0	BG0	115	116	ALERT_n	Alert
Versorgungsspannung 1,2 V	VCC	117	118	VCC	Versorgungsspannung 1,2 V
Adressleitung 12	A12	119	120	A11	Adressleitung 11
Adressleitung 9	A9	121	122	A7	Adressleitung 7
Versorgungsspannung 1,2 V	VCC	123	124	VCC	Versorgungsspannung 1,2 V
Adressleitung 8	A8	125	126	A5	Adressleitung 5
Adressleitung 6	A6	127	128	A4	Adressleitung 4
Versorgungsspannung 1,2 V	VCC	129	130	VCC	Versorgungsspannung 1,2 V
Adressleitung 3	A3	131	132	A2	Adressleitung 2
Adressleitung 1	A1	133	134	EVENT_n	Event
Versorgungsspannung 1,2 V	VCC	135	136	VCC	Versorgungsspannung 1,2 V
Clock-Signal 0 +	CK0	137	138	CK1	Clock 1 +
Clock-Signal 0 -	CK0#	139	140	CK1#	Clock 1 -
Versorgungsspannung 1,2 V	VCC	141	142	VCC	Versorgungsspannung 1,2 V
Even parity check	PAR	143	144	A0	Adressleitung 0
SDRAM Bank 2	BA1	145	146	A10/AP	Adressleitung 10/ Autoprecharge
Versorgungsspannung 1,2 V	VCC	147	148	VCC	Versorgungsspannung 1,2 V
Chip Select 0	CS0_n	149	150	BA0	Bank Adress 0
Adressleitung 14/Write Enable	A14/WE_n	151	152	A16/RAS_n	Adressleitung 16/ Row Address Strobe
Versorgungsspannung 1,2 V	VCC	153	154	VCC	Versorgungsspannung 1,2 V
On Die Termination 0	ODT0	155	156	A15/CAS_n	Adressleitung 15/ Column Address Strobe
Chip Select 1	CS1_n	157	158	A13	Adressleitung 13
Versorgungsspannung 1,2 V	VCC	159	160	VCC	Versorgungsspannung 1,2 V
On Die Termination 1	ODT1	161	162	S2/NC	Nicht verbunden
Versorgungsspannung 1,2 V	VCC	163	164	VREFCA	Referenzspannung
Nicht verbunden	S3/NC	165	166	SA2	SPD-Adresse 2
Masse	GND	167	168	GND	Masse
Datenleitung 37	DQ37	169	170	DQ36	Datenleitung 36
Masse	GND	171	172	GND	Masse
Datenleitung 33	DQ33	173	174	DQ32	Datenleitung 32
Masse	GND	175	176	GND	Masse
Data Strobe 4 -	DQS4#	177	178	DQM4	Data Mask 4
Data Strobe 4 +	DQS4	179	180	GND	Masse
Masse	GND	181	182	DQ39	Datenleitung 39

Pinbelegung SO-DIMM260					
Beschreibung	Name	Pin		Name	Beschreibung
Datenleitung 38	DQ38	183	184	GND	Masse
Masse	GND	185	186	DQ35	Datenleitung 35
Datenleitung 34	DQ34	187	188	GND	Masse
Masse	GND	189	190	DQ45	Datenleitung 45
Datenleitung 44	DQ44	191	192	GND	Masse
Masse	GND	193	194	DQ41	Datenleitung 41
Datenleitung 40	DQ40	195	196	GND	Masse
Masse	GND	197	198	DQS5#	Data Strobe 5 -
Nicht verbunden	NC	199	200	DQS5	Data Strobe 5 +
Masse	GND	201	202	GND	Masse
Datenleitung 46	DQ46	203	204	DQ47	Datenleitung 47
Masse	GND	205	206	GND	Masse
Datenleitung 42	DQ42	207	208	DQ43	Datenleitung 43
Masse	GND	209	210	GND	Masse
Datenleitung 52	DQ52	211	212	DQ53	Datenleitung 53
Masse	GND	213	214	GND	Masse
Datenleitung 49	DQ49	215	216	DQ48	Datenleitung 48
Masse	GND	217	218	GND	Masse
Data Strobe 6 -	DQS6#	219	220	DQM6	Data Mask 6
Data Strobe 6 +	DQS6	221	222	GND	Masse
Masse	GND	223	224	DQ54	Datenleitung 54
Datenleitung 55	DQ55	225	226	GND	Masse
Masse	GND	227	228	DQ50	Datenleitung 50
Datenleitung 51	DQ51	229	230	GND	Masse
Masse	GND	231	232	DQ60	Datenleitung 60
Datenleitung 61	DQ61	233	234	GND	Masse
Masse	GND	235	236	DQ57	Datenleitung 57
Datenleitung 56	DQ56	237	238	GND	Masse
Masse	GND	239	240	DQS7#	Data Strobe 7 -
Data Mask 7	DQM7	241	242	DQS7	Data Strobe 7 +
Masse	GND	243	244	GND	Masse
Datenleitung 62	DQ62	245	246	DQ63	Datenleitung 63
Masse	GND	247	248	GND	Masse
Datenleitung 58	DQ58	249	250	DQ59	Datenleitung 59
Masse	GND	251	252	GND	Masse
SMBus Clock	SCL	253	254	SDA	SMBus Data
I ² C Power für SPD EEPROM	VCCSPD	255	256	SA0	SPD-Adresse 0
DRAM Activating Power	VPP	257	258	M_VTT	Terminierungsspannung
DRAM Activating Power	VPP	259	260	SA1	SPD-Adresse 1

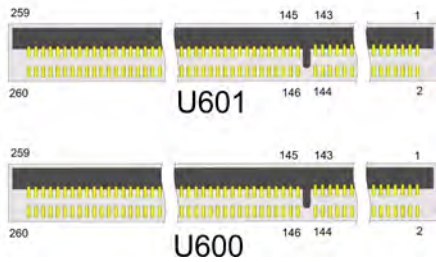
6.13 USB 2.0 intern (P1202/P1204)

Die USB-Kanäle 9 bis 14 werden über zwei Wannenstecker zur Verfügung gestellt.

Dabei werden die Kanäle 9 bis 12 über einen 2x8-poligen Wannenstecker, die Kanäle 13 und 14 über einen 2x4-poligen Wannenstecker herausgeführt.

Die USB-Kanäle unterstützen die USB-Spezifikation 2.0. Durch das BIOS können alle notwendigen Einstellungen für USB durchgeführt werden. Es ist zu beachten, dass die Funktionalität „USB-Maus und Tastatur“ des BIOS-Setup nur benötigt wird, wenn das Betriebssystem keine USB-Unterstützung bietet. Für Einstellungen im Setup und zum Booten von Windows mit einer angeschlossenen USB-Maus und Tastatur sollte diese Funktion nicht gewählt werden, weil dies zu erheblichen Leistungseinschränkungen führen würde.

Die einzelnen USB-Schnittstellen können bis zu 500 mA Strom liefern und sind elektronisch abgesichert.



Abb. 14: CB3067-USB2.0 (P1204)

Pinbelegung 2x8-poliger Wannenstecker USB 9 - 12					
Beschreibung	Name	Pin		Name	Beschreibung
5 V für USB9	VCC	1	9	VCC	5 V für USB10
Minus-Datenkanal USB9	USB9-	2	10	USB10-	Minus-Datenkanal US10
Plus-Datenkanal USB9	USB9+	3	11	USB10+	Plus-Datenkanal USB10
Masse	GND	4	12	GND	Masse
Masse	GND	5	13	GND	Masse
Plus-Datenkanal USB12	USB12+	6	14	USB11+	Plus-Datenkanal USB11
Minus-Datenkanal USB12	USB12-	7	15	USB11-	Minus-Datenkanal USB11
5 V für USB12	VCC	8	16	VCC	5 V für USB11

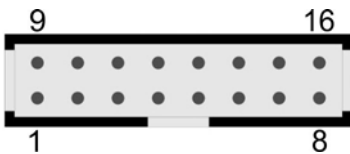

Abb. 15: CB3067-USB2.0 (P1202)

Pinbelegung 2x4-poliger Wannenstecker USB 13/14					
Beschreibung	Name	Pin		Name	Beschreibung
5 V für USB13	VCC	1	5	VCC	5 V für USB14
Minus-Datenkanal USB13	USB13-	2	6	USB14-	Minus-Datenkanal US14
Plus-Datenkanal USB13	USB13+	3	7	USB14+	Plus-Datenkanal USB14
Masse	GND	4	8	GND	Masse

6.14 Systemstecker (P1102)

Zum Anschluss der systemtypischen Signale wird ein 2x12-poliger Wannenstecker benutzt. Hier werden Powerbutton, Reset, Speaker, LEDs für Harddisk und für Suspend-Modus angeschlossen sowie drei weitere Status-LEDs, die über GPIOs angesteuert werden. Von diesen drei LEDs sind LED1 und LED2 bereits mit Vorwiderständen ausgestattet. Die Pinbelegung ist so gestaltet, dass zusammengehörige Pins gegenüber bzw. nahe beieinander liegen.

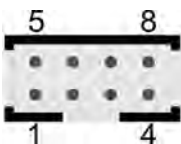

Abb. 16: CB3067-Systemstecker (P1102)

Pinbelegung Systemstecker					
Beschreibung	Name	Pin		Name	Beschreibung
Masse	GND	1	14	3,3V	Versorgungsspannung 3,3 V
Reset nach Masse	RSTBTTN#	2	14	PWRBTN#	On/Suspend-Taste
LED Suspend/ACPI	S-LED	3	15	S3,3V	Standby-Versorgung 3,3 V
LED Harddisk	SATALED	4	16	GPIOLED3	LED GPIO-Gerät 3
LED GPIO-Gerät 1	GPIOLED1	5	17	BATT	RTC-Batterie
LED GPIO-Gerät 2	GPIOLED2	6	18	SMBALERT#	SMB Alert
SMB Clock	SMBCLKEX	7	19	SMBDATEXT	SMB Data
Lautsprecher	SPEAKER	8	20	SVCC	Standby-Versorgung 5 V
Reserviert	NC	9	21	NC	Reserviert
Masse	GND	10	22	VCC	Versorgungsspannung 5 V
Masse	GND	11	23	VCC	Versorgungsspannung 5 V
Masse	GND	12	24	VCC	Versorgungsspannung 5 V

6.15 PCI-Express-Stecker (P1101)

Das CB3067 ist mit einem herstellereigenen 2x40-poligen Stecker ausgestattet, über den PCI-Express-Geräte angeschlossen werden können. Es können entweder bis zu vier PCIe1x-Geräte oder genau ein PCIe x4-Gerät angeschlossen werden. Adapterkarten mit Standard-PCIe-Sockeln sowie mit PCIe-Mini-Card-Stecker sind als Zubehör erhältlich. Bitte kontaktieren Sie hierfür Ihren Distributor.

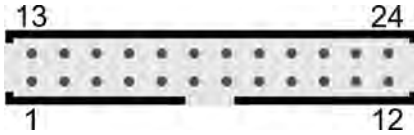

Abb. 17: CB3067-PCIE (P1101)

Pinbelegung PCI-Express-Stecker					
Beschreibung	Name	Pin		Name	Beschreibung
Versorgungsspannung 3,3 V	3,3V	1	2	12V	Versorgungsspannung 12 V
Standby-Versorgung 3,3 V	S3,3V	3	4	SMCLK1	SMB Clock Slot 1
PCIe Reset 1 -	PERST1#	5	6	SMDAT1	SMB Dat Slot 1
Link Reactivation 1 -	WAKE1#	7	8	GND	Masse
Masse	GND	9	10	REFCLK1	PCIe Clock 1 +
Transmit Lane 1 +	PET1	11	12	REFCLK1#	PCIe Clock 1 -
Transmit Lane 1 -	PET1#	13	14	GND	Masse
Masse	GND	15	16	PER1	Receive Lane 1 +
Clock Enable 1 -	PRSNT1#	17	18	PER1#	Receive Lane 1 -
Masse	GND	19	20	GND	Masse
Versorgungsspannung 3,3 V	3,3V	21	22	12V	Versorgungsspannung 12 V
Standby-Versorgung 3,3 V	S3,3V	23	24	SMCLK2	SMB Clock Slot 2
PCIe Reset 2 -	PERST2#	25	26	SMDAT2	SMB Dat Slot 2
Link Reactivation 2 -	WAKE2#	27	28	GND	Masse
Masse	GND	29	30	REFCLK2	PCIe Clock 2 +
Transmit Lane 2 +	PET2	31	32	REFCLK2#	PCIe Clock 2 -
Transmit Lane 2 -	PET2#	33	34	GND	Masse
Masse	GND	35	36	PER2	Receive Lane 2 +
Clock Enable 2 -	PRSNT2#	37	38	PER2#	Receive Lane 2 -
Masse	GND	39	40	GND	Masse
Versorgungsspannung 3,3 V	3,3V	41	42	12V	Versorgungsspannung 12 V
Standby-Versorgung 3,3 V	S3,3V	43	44	SMCLK3	SMB Clock Slot 3
PCIe Reset 3 -	PERST3#	45	46	SMDAT3	SMB Dat Slot 3
Link Reactivation 3 -	WAKE3#	47	48	GND	Masse
Masse	GND	49	50	REFCLK3	PCIe Clock 3 +
Transmit Lane 3 +	PET3	51	52	REFCLK3#	PCIe Clock 3 -
Transmit Lane 3 -	PET3#	53	54	GND	Masse
Masse	GND	55	56	PER3	Receive Lane 3 +
Clock Enable 3 -	PRSNT3#	57	58	PER3#	Receive Lane 3 -
Masse	GND	59	60	GND	Masse
Versorgungsspannung 3,3 V	3,3V	61	62	12V	Versorgungsspannung 12 V
Standby-Versorgung 3,3 V	S3,3V	63	64	SMCLK4	SMB Clock Slot 4
PCIe Reset 4 -	PERST4#	65	66	SMDAT4	SMB Dat Slot 4
Link Reactivation 4 -	WAKE4#	67	68	GND	Masse
Masse	GND	69	70	REFCLK4	PCIe Clock 4 +
Transmit Lane 4 +	PET4	71	72	REFCLK4#	PCIe Clock 4 -
Transmit Lane 4 -	PET4#	73	74	GND	Masse
Masse	GND	75	76	PER4	Receive Lane 4 +
Clock Enable 4 -	PRSNT4#	77	78	PER4#	Receive Lane 4 -
PCIe Konfiguration x1/x4	PECONF x1/ x4	79	80	GND	Masse

7 Status LEDs

7.1 RGB LED

Auf dem CB3067 befindet sich eine RGB-LED, mit der über Farben und Blinkintervalle Statusmeldungen des Powercontrollers ausgegeben werden.

Farbe	Intervall	Bedeutung
Keine	Dauerhaft	Fehlerhafter Systemzustand
Weiß	Dauerhaft	Powerfail
Cyan	Dauerhaft	Reserviert
Magenta	Dauerhaft	SUSV aktiv (falls vorhanden)
Blau	Dauerhaft	Reserviert
Gelb	Dauerhaft	S5-Zustand
Grün	Dauerhaft	S0-Zustand
Rot	Dauerhaft	Reset/Start
Grün/Gelb	Blinkend	Bootloader läuft fehlerfrei
Rot/Gelb	Blinkend	Bootloader wird gestartet (Startsequenz wird durchlaufen)
Gelb	Blinkend (6 s)	S4-Zustand
Gelb	Blinkend (3 s)	S3-Zustand
Magenta	Blinkend (0,5 s)	SUSV-Kapazitätstest (falls SUSV vorhanden)
Rot/Magenta	Blinkend	Checksummenfehler bei der I ² C-Übertragung im Bootloader

Eine dauerhaft rot leuchtende LED kann auf einen Hardwarefehler hinweisen.

● Anpassung der Statuscodes

i Es ist möglich, die Statuscodes anzupassen (z.B. als TwinCAT-LED). Dazu können die Systemfarben mithilfe eines SMB-Kommandos verändert werden. Diese Änderung bleibt bis zum nächsten Neustart bzw. Reset bestehen. Eine Änderung der Default-Farben wird durch zusätzliches Blinken der weißen LED angezeigt.

8 BIOS-Einstellungen

8.1 Benutzung des Setups

Innerhalb der einzelnen Setup-Seiten können jederzeit mit F2 („Previous Values“) die zuletzt abgespeicherten Einstellungen wieder hergestellt werden. Mit F3 („Optimized Defaults“) werden werkseitig festgelegte Standardwerte geladen. F2/F3 und auch F4 ("Save & Exit") laden bzw. sichern immer den kompletten Satz an Einstellungen.

Ein „▶“-Zeichen vor dem Menüpunkt bedeutet, dass ein Untermenü vorhanden ist. Die Navigation von einem Menüpunkt zum anderen erfolgt mit Hilfe der Pfeiltasten, wobei mit der Enter-Taste der entsprechende Menüpunkt ausgewählt wird, was dann z. B. den Aufruf eines Untermenüs oder eines Auswahldialogs bewirkt.

Zu jeder einzelnen Setup-Option wird oben rechts ein Hilfetext angezeigt, der in vielen Fällen nützliche Informationen zur Bedeutung der Option, zu erlaubten Werten usw., enthält.

● Hinweis zur Setup-Dokumentation

i Das BIOS wird regelmäßig weiterentwickelt, so dass die verfügbaren Setup-Optionen sich jederzeit und ohne gesonderte Mitteilung ändern können. Dadurch kann es zu Abweichungen kommen zwischen den tatsächlich vorhandenen Optionen und denen, die nachfolgend beschrieben werden. Zu beachten ist außerdem, dass die in den Setup-Menüs im Folgenden gezeigten Einstellungen nicht notwendigerweise die empfohlenen oder die Default-Einstellungen sind. Welche Einstellungen gewählt werden müssen, hängt jeweils vom Anwendungsszenario ab, in dem das Board betrieben wird.

8.2 Main

Aptio Setup Utility - Copyright (C) 2020 American Megatrends, Inc.

Main Advanced Chipset Security Boot Save & Exit

<pre> Board Information Board CB3067 Revision 2 Bios Version 0.20 Processor Information Name CoffeeLake DT Type Intel(R) Pentium(R) Gold G5400 CPU @ 3.70GHz Speed 3700 MHz ID 0x906EA Stepping U0 Number of Processors 2Core(s) / 2Thread(s) Microcode Revision D6 GT Info GT1 (0x3E90) IGFX VBIOS Version N/A IGFX GOP Version 9.0.1105 Memory RC Version 0.7.1.119 Total Memory 16384 MB Memory Frequency 2133 MHz PCH Information Name CNL PCH-H Stepping BO ME FW Version 12.0.70.1652 System Date [Tue 05/10/2021] System Time [04:19:12] </pre>	<pre> Set the Date. Use Tab to switch between Date elements. Default Ranges: Year: 2005-2099 Months: 1-12 Days: dependent on month ----- ←: Select Screen ↑↓: Select Item Enter: Select +/-: Change Opt. F1: General Help F2: Previous Values F3: Optimized Defaults F4: Save & Reset ESC: Exit </pre>
--	---

Version 2.20.1275. Copyright (C) 2020 American Megatrends, Inc.

Bios-Eintrag	Option
Board Information	
Board*	Keine
Revision	Keine
Bios Version	Keine
Processor Information	
Name	Keine
Type	Keine
Speed	Keine
ID	Keine
Stepping	Keine
Number of Processors	Keine
Microcode Revision	Keine
GT Info	Keine
IGFX VBIOS Version	Keine
IGFX GOP Version	Keine
Memory RC Version	Keine
Total Memory	Keine
Memory Frequency	Keine
PCH Information	
Name	Keine
Stepping	Keine
ME FW Version	Keine
System Date	Hier können Sie das Systemdatum ändern.
System Time	Hier können Sie die Systemzeit ändern.

8.3 Advanced Menu

Aptio Setup Utility - Copyright (C) 2020 American Megatrends, Inc.

Main **Advanced** Chipset Security Boot Save & Exit

<pre> Power-Supply Type [ATX] SoftOff on Overheat [Disabled] Show Postcode on screen [Enabled] > RC ACPI Settings > CPU Configuration > Trusted Computing > ACPI Settings > SCH3114 Super IO Configuration > Hardware Monitor > Serial Port Console Redirection > AMI Graphic Output Protocol Policy > PCI Subsystem Settings > USB Configuration > NVMe Configuration > Power Controller Options > SATA And RST Configuration > AMT Configuration > Tls Auth Configuration > Network Stack Configuration > Intel(R) Rapid Store Technology > Intel(R) I210 Gigabit Network Connection XX:XX:XX:XX:XX:XX > Intel(R) Ethernet Connection (2) I219LM XX:XX:XX:XX:XX:XX > Driver Health </pre>	<p>Select the Type of the Power Supply: AT/ATX</p> <hr/> <pre> ←→: Select Screen ↑↓: Select Item Enter: Select +/-: Change Opt. F1: General Help F2: Previous Values F3: Optimized Defaults F4: Save & Reset ESC: Exit </pre>
--	---

Version 2.20.1275. Copyright (C) 2020 American Megatrends, Inc.

Bios-Eintrag	Option
Power-Supply Type	[ATX/AT]
SoftOff on Overheat	Disabled/Enabled/Enabled (Emulate PwrBtn)
Show postcode on screen	Disabled/Enabled
RC ACPI Settings	Untermenü siehe: RC ACPI Settings [▶ 37]
CPU Configuration	Untermenü siehe: CPU Configuration [▶ 38]
Trusted Computing	Untermenü siehe: Trusted Computing [▶ 39]
ACPI Settings	Untermenü siehe: ACPI Settings Enabled [▶ 39]
SCH3114 Super IO Configuration	Untermenü siehe: SCH3114 Super IO Configuration [▶ 41]
Hardware Monitor	Untermenü siehe: Hardware Monitor [▶ 46]
Serial Port Console Redirection	Untermenü siehe: Serial Port Console Redirection [▶ 47]
AMI Graphic Output Protocol Policy	Untermenü siehe: AMI Graphic Output Protocol Policy [▶ 52]
PCI Subsystem Settings	Untermenü siehe: PCI Subsystem Settings [▶ 53]
USB Configuration	Untermenü siehe: USB Configuration [▶ 55]
NVMe Configuration	Untermenü siehe: NVMe Configuration [▶ 56]
Power Controller Options	Untermenü siehe: Power Controller Options [▶ 57]
SATA And RST Configuration	Untermenü siehe: SATA und RST Configuration [▶ 58]
AMT Configuration	Untermenü siehe: AMT Configuration [▶ 61]
Tls Auth Configuration	Untermenü siehe: TLs Auth Configuration [▶ 65]
Network Stack Configuration	Untermenü siehe: Network Stack Configuration [▶ 68]
Intel® Rapid Store Technology	Untermenü siehe: Intel Rapid Storage Technology [▶ 70]
Intel(R) I210 Gigabit Network Connection XX:XX:XX:XX:XX:XX	Untermenü siehe: NIC Configuration [▶ 72]
Intel(R) Ethernet Connection (2) I219LM XX:XX:XX:XX:XX:XX	Untermenü siehe: NIC Configuration [▶ 74]
Driver Health	Untermenü siehe: Driver Health [▶ 75]

8.3.1 RC ACPI Settings

Aptio Setup Utility - Copyright (C) 2020 American Megatrends, Inc.

Advanced

RC ACPI Settings PTID Support [Enabled] PECI Access Method [Direct I/O] Native PCIE Enable [Enabled] PUIS Enable [Disabled] MSI enabled [Enabled]	PTID Support will be loaded if enabled. ><: Select Screen ^v: Select Item Enter: Select +/-: Change Opt. F1: General Help F2: Previous Values F3: Optimized Defaults F4: Save & Reset ESC: Exit
--	--

Version 2.20.1275. Copyright (C) 2020 American Megatrends, Inc.

Bios-Eintrag	Optionen
RC ACPI Settings	
PTID Support	Enabled/Disabled
PECI Access Method	Direct I/O
Native PCIE Enable	Enabled/Disabled
PUIS Enable	Keine
MSI enabled	Enabled/Disabled

8.3.2 CPU Configuration

Aptio Setup Utility - Copyright (C) 2020 American Megatrends, Inc.

Advanced

CPU Configuration		Enable/Disable Software Guard Extensions (SGX)
Type	Intel(R) Pentium(R) Gold G5400 CPU @ 3.70GHz	
ID	0x906EA	
Speed	3700 MHz	
L1 Data Cache	32 KB x 2	
L1 Instruction Cache	32 KB x 2	
L2 Cache	256 KB x 2	
L3 Cache	4 MB	
L4 Cache	N/A	
VMX	Supported	
SMX/TXT	Not Supported	
Software Guard Extensions (SGX)	[Disabled]	><: Select Screen ^v: Select Item Enter: Select +/-: Change Opt. F1: General Help F2: Previous Values F3: Optimized Defaults F4: Save & Reset ESC: Exit
Hardware Prefetcher	[Enabled]	
Adjacent Cache Line Prefetch	[Enabled]	
Intel (VMX) Virtualization Technology	[Enabled]	
PECI	[Enabled]	
Active Processor Cores	[All]	
AES	[Enabled]	

Version 2.20.1275. Copyright (C) 2020 American Megatrends, Inc.

Bios-Eintrag	Optionen
CPU Configuration	
Type	Keine
ID	Keine
Speed	Keine
L1 Data Cache	Keine
L1 Instruction Cache	Keine
L2 Cache	Keine
L3 Cache	Keine
L4 Cache	Keine
VMX	Keine
SMX/TXT	Keine
Software Guard Extensions (SGX)	Disabled/Enabled/Software Controlled
Hardware Prefetcher	Enabled/Disabled
Adjacent Cache Line Prefetch	Enabled/Disabled
Intel (VMX) Virtualization Technology	Enabled/Disabled
PECI	Enabled/Disabled
Active Processor Cores	All/1/2/3
AES	Enabled/Disabled

8.3.3 Trusted Computing

Aptio Setup Utility - Copyright (C) 2020 American Megatrends, Inc.
Advanced

Configuration Security Device Support [Disable] NO Security Device Found	Enables or Disables BIOS support for security device. O.S. will not show Security Device. TCG EFI protocol and INT1A interface will not be available.
><: Select Screen ^v: Select Item Enter: Select +/-: Change Opt. F1: General Help F2: Previous Values F3: Optimized Defaults F4: Save & Reset ESC: Exit	

Version 2.20.1275. Copyright (C) 2020 American Megatrends, Inc.

Bios-Eintrag	Optionen
Configuration	
Security Device Support	Disable/Enable
No Security Device Found	Keine

8.3.4 ACPI Settings Enabled

Aptio Setup Utility - Copyright (C) 2020 American Megatrends, Inc.
Advanced

ACPI Settings Enable ACPI Auto Configuration [Enabled] S3 - Suspend to RAM	Enables or Disables BIOS ACPI auto Configuration.
><: Select Screen ^v: Select Item Enter: Select +/-: Change Opt. F1: General Help F2: Previous Values F3: Optimized Defaults F4: Save & Reset ESC: Exit	

Version 2.20.1275. Copyright (C) 2020 American Megatrends, Inc.

Bios-Eintrag	Optionen
ACPI Settings	
Enable ACPI Auto Configuration	Disabled/Enabled
S - 3 Suspend ro RAM	Keine

8.3.5 ACPI Settings Disabled

Aptio Setup Utility - Copyright (C) 2020 American Megatrends, Inc.

Advanced

ACPI Settings Enable ACPI Auto Configuration [Disabled] S3 – Suspend to RAM Enable Hibernation [Enabled] Lock Legacy Resources [Disabled]	Enables or Disables BIOS ACPI Auto Configuration. ←: Select Screen ↑↓: Select Item Enter: Select +/-: Change Opt. F1: General Help F2: Previous Values F3: Optimized Defaults F4: Save & Reset ESC: Exit
--	---

Version 2.20.1275. Copyright (C) 2020 American Megatrends, Inc.

Bios-Eintrag	Optionen
ACPI Settings	
Enable ACPI Auto Configuration	Enabled/Disabled
S3 – Suspend to RAM	Keine
Enable Hibernation	Disabled/Enabled
Lock Legacy Resources	Disabled/Enabled

8.3.6 SCH3114 Super IO Configuration

Aptio Setup Utility - Copyright (C) 2020 American Megatrends, Inc.
Main **Advanced** Chipset Security Boot Save & Exit

SCH3114 Super IO Configuration Super IO Chip SCH3114 > Serial Port 1 Configuration > Serial Port 2 Configuration > Serial Port 3 Configuration > Serial Port 4 Configuration	Set Parameters of Serial Port 1 (COMA)
	→: Select Screen ↑↓: Select Item Enter: Select +/-: Change Opt. F1: General Help F2: Previous Values F3: Optimized Defaults F4: Save & Reset ESC: Exit

Version 2.20.1275. Copyright (C) 2020 American Megatrends, Inc.

Bios-Eintrag	Optionen
SCH3114 Super IO Configuration	
Super IO Chip	
Serial Port 1 Configuration	Untermenü siehe: Serial Port 1 Configuration > 42
Serial Port 2 Configuration	Untermenü siehe: Serial Port 2 Configuration > 43
Serial Port 3 Configuration	Untermenü siehe: Serial Port 3 Configuration > 44
Serial Port 4 Configuration	Untermenü siehe: Serial Port 4 Configuration > 45

8.3.6.1 Serial Port 1 Configuration

Aptio Setup Utility - Copyright (C) 2020 American Megatrends, Inc.
 Main **Advanced** Chipset Security Boot Save & Exit

Serial Port 1 Configuration Serial Port [Enabled] Device Settings IO=3F8h; IRQ=4; Change Settings [Auto] Device Mode [Normal]	Change the Serial Port mode (COM) ←: Select Screen ↑↓: Select Item Enter: Select +/-: Change Opt. F1: General Help F2: Previous Values F3: Optimized Defaults F4: Save & Reset ESC: Exit
---	---

Version 2.20.1275. Copyright (C) 2020 American Megatrends, Inc.

Bios-Eintrag	Optionen
Serial Port 1 Configuration	
Serial Port	Enabled/Disabled
Device Settings	Keine
Change Settings	Auto/IO=3F8h; IRQ=4;...IO=3F8h; IRQ=3,4,5,6,7,9,10,11,12; und weitere
Device Mode	Normal/High Speed

8.3.6.2 Serial Port 2 Configuration

Aptio Setup Utility - Copyright (C) 2020 American Megatrends, Inc.

Main **Advanced** Chipset Security Boot Save & Exit

Serial Port 2 Configuration Serial Port [Enabled] Device Settings IO=2F8h; IRQ=3; Change Settings [Auto] Device Mode [Normal]	Change the Serial Port mode. ←: Select Screen ↑↓: Select Item Enter: Select +/-: Change Opt. F1: General Help F2: Previous Values F3: Optimized Defaults F4: Save & Reset ESC: Exit
---	--

Version 2.20.1275. Copyright (C) 2020 American Megatrends, Inc.

Bios-Eintrag	Optionen
Serial Port 2 Configuration	
Serial Port	Enabled/Disabled
Device Settings	Keine
Change Settings	Auto/IO=2F8h; IRQ=3;...IO=2E8h; IRQ=3,4,5,6,7,9,10,11,12; und weitere
Device Mode	Normal/High Speed

8.3.6.3 Serial Port 3 Configuration

Aptio Setup Utility - Copyright (C) 2020 American Megatrends, Inc.
 Main **Advanced** Chipset Security Boot Save & Exit

Serial Port 3 Configuration Serial Port [Enabled] Device Settings IO=3E8h; IRQ11; Change Settings [Auto] Device Mode [Normal]	Change the Serial Port mode. ←: Select Screen ↑↓: Select Item Enter: Select +/-: Change Opt. F1: General Help F2: Previous Values F3: Optimized Defaults F4: Save & Reset ESC: Exit
---	--

Version 2.20.1275. Copyright (C) 2020 American Megatrends, Inc.

Bios-Eintrag	Optionen
Serial Port 3 Configuration	
Serial Port	Enabled/Disabled
Device Settings	Keine
Change Settings	Auto/IO=3E8h; IRQ=11;...IO=2E8h; IRQ=3,4,5,6,7,9,10,11,12; und weitere
Device Mode	Normal/High Speed

8.3.6.4 Serial Port 4 Configuration

Aptio Setup Utility - Copyright (C) 2020 American Megatrends, Inc.

Main **Advanced** Chipset Security Boot Save & Exit

Serial Port 4 Configuration Serial Port [Enabled] Device Settings IO=2E8h; IRQ=7; Change Settings [Auto] Device Mode [Normal]	Change the Serial Port mode. ←: Select Screen ↑↓: Select Item Enter: Select +/-: Change Opt. F1: General Help F2: Previous Values F3: Optimized Defaults F4: Save & Reset ESC: Exit
---	--

Version 2.20.1275. Copyright (C) 2020 American Megatrends, Inc.

Bios-Eintrag	Optionen
Serial Port 4 Configuration	
Serial Port	Enabled/Disabled
Device Settings	Keine
Change Settings	Auto/IO=2E8h; IRQ=10;...IO=2E8h; IRQ=3,4,5,6,7,9,10,11,12; und weitere
Device Mode	Normal/High Speed

8.3.7 Hardware Monitor

Aptio Setup Utility - Copyright (C) 2020 American Megatrends, Inc.

Advanced

<pre> PC Health Status CPU dig. : +48 'C VCCCORE : +1.08 V 5V : +4.94 V 12V : +12.12 V VBATT : +3.01 V 3.3V : +3.31 V SIO Temp : +28 V 1.05V : +1.05 V Memory VDD : +1.22 V FAN 1 : N/A FAN 2 : 2182 RPM FAN 3 : N/A MB Temp : +29 'C Memory Temp : +28 'C PwrCtrlTemp : +31 'C PwrCtrlVCC : +5.10 V </pre>	<pre> ←: Select Screen ↑↓: Select Item Enter: Select +/-: Change Opt. F1: General Help F2: Previous Values F3: Optimized Defaults F4: Save & Reset ESC: Exit </pre>
---	---

Version 2.20.1275. Copyright (C) 2020 American Megatrends, Inc.

Bios-Eintrag	Optionen
PC Health Status	Keine

8.3.8 Serial Port Console Redirection

Aptio Setup Utility - Copyright (C) 2020 American Megatrends, Inc.

Main **Advanced** Chipset Security Boot Save & Exit

COM0 Console Redirection [Disabled] > Console Redirection Settings	Console Redirection Enable or Disable.
COM1 Console Redirection [Disabled] > Console Redirection Settings	
COM2 Console Redirection [Disabled] > Console Redirection Settings	←: Select Screen ↑↓: Select Item Enter: Select +/-: Change Opt. F1: General Help F2: Previous Values F3: Optimized Defaults F4: Save & Reset ESC: Exit
COM3 Console Redirection [Disabled] > Console Redirection Settings	
COM4 (PCI Bus0,Dev0,Func0) (Disabled) Console Redirection Port Is Disabled	

Version 2.20.1275. Copyright (C) 2020 American Megatrends, Inc.

Bios-Eintrag	Optionen
COM0	
Console Redirection	Disabled/Enabled
Console Redirection Settings	Untermenü siehe: COM0 Console Redirection Settings [▶ 48]
COM1	
Console Redirection	Disabled/Enabled
Console Redirection Settings	Untermenü siehe: COM1 Console Redirection Settings [▶ 49]
COM2	
Console Redirection	Disabled/Enabled
Console Redirection Settings	Untermenü siehe: COM2 Console Redirection Settings [▶ 50]
COM3	
Console Redirection	Disabled/Enabled
Console Redirection Settings	Untermenü siehe: COM3 Console Redirection Settings [▶ 51]
COM4 (Pci Bus0, Dev0, Func0) (Disabled)	
Console Redirection	Port Is Disabled

8.3.8.1 COM0 Console Redirection Settings

Aptio Setup Utility - Copyright (C) 2020 American Megatrends, Inc.
 Main **Advanced** Chipset Security Boot Save & Exit

COM0 Console Redirection Settings Terminal Type [ANSI] Bits per second [115200] Data Bits [8] Parity [None] Stop Bits [1] Flow Control [None] VT-UTF8 Combo Key Support [Enabled] Recorder Mode [Disabled] Resolution 100x31 [Disabled] Putty KeyPad [VT100]	Emulation: ANSI: Extended ASCII char set. VT100: ASCII char set. VT100+: Extends VT100 to support color, function keys, etc. VT-UTF8: Uses UTF8 encoding to map Unicode chars onto 1 or more bytes. ←: Select Screen ↑↓: Select Item Enter: Select +/-: Change Opt. F1: General Help F2: Previous Values F3: Optimized Defaults F4: Save & Reset ESC: Exit
---	---

Version 2.20.1275. Copyright (C) 2020 American Megatrends, Inc.

Bios-Eintrag	Optionen
COM0	
Console Redirection Settings	
Serial Port Terminal Type	VT100/VT100+/VT-UTF8/ANSI
Bits per second	9600/19200/38400/57600/115200
Data Bits	7/8
Parity	None/Even/Odd/Mark/Space
Stop Bits	1/2
Flow Control	None/Hardware RTS/CTS
VT-UTF8 Combo Key Support	Enabled/Disabled
Recorder Mode	Disabled/Enabled
Resolution 100x31	Disabled/Enabled
Putty KeyPad	VT100/LINUX/XTERMR6/SCO/ESCN/VT400

8.3.8.2 COM1 Console Redirection Settings

Aptio Setup Utility - Copyright (C) 2020 American Megatrends, Inc.
 Main **Advanced** Chipset Security Boot Save & Exit

COM1 Console Redirection Settings Terminal Type [ANSI] Bits per second [115200] Data Bits [8] Parity [None] Stop Bits [1] Flow Control [None] VT-UTF8 Combo Key Support [Enabled] Recorder Mode [Disabled] Resolution 100x31 [Disabled] Putty KeyPad [VT100]	Emulation: ANSI: Extended ASCII char set. VT100: ASCII char set. VT100+: Extends VT100 to support color, function keys, etc. VT-UTF8: Uses UTF8 encoding to map Unicode chars onto 1 or more bytes. ←: Select Screen ↑↓: Select Item Enter: Select +/-: Change Opt. F1: General Help F2: Previous Values F3: Optimized Defaults F4: Save & Reset ESC: Exit
---	---

Version 2.20.1275. Copyright (C) 2020 American Megatrends, Inc.

Bios-Eintrag	Optionen
COM1	
Console Redirection Settings	
Serial Port Terminal Type	VT100/VT100+/VT-UTF8/ANSI
Bits per second	9600/19200/38400/57600/115200
Data Bits	7/8
Parity	None/Even/Odd/Mark/Space
Stop Bits	1/2
Flow Control	None/Hardware RTS/CTS
VT-UTF8 Combo Key Support	Enabled/Disabled
Recorder Mode	Disabled/Enabled
Resolution 100x31	Disabled/Enabled
Putty KeyPad	VT100/LINUX/XTERMR6/SCO/ESCN/VT400

8.3.8.3 COM2 Console Redirection Settings

Aptio Setup Utility - Copyright (C) 2020 American Megatrends, Inc.
 Main **Advanced** Chipset Security Boot Save & Exit

COM2 Console Redirection Settings Terminal Type [ANSI] Bits per second [115200] Data Bits [8] Parity [None] Stop Bits [1] Flow Control [None] VT-UTF8 Combo Key Support [Enabled] Recorder Mode [Disabled] Resolution 100x31 [Disabled] Putty KeyPad [VT100]	Emulation: ANSI: Extended ASCII char set. VT100: ASCII char set. VT100+: Extends VT100 to support color, function keys, etc. VT-UTF8: Uses UTF8 encoding to map Unicode chars onto 1 or more bytes. ←: Select Screen ↑↓: Select Item Enter: Select +/-: Change Opt. F1: General Help F2: Previous Values F3: Optimized Defaults F4: Save & Reset ESC: Exit
---	---

Version 2.20.1275. Copyright (C) 2020 American Megatrends, Inc.

Bios-Eintrag	Optionen
COM2	
Console Redirection Settings	
Serial Port Terminal Type	VT100/VT100+/VT-UTF8/ANSI
Bits per second	9600/19200/38400/57600/115200
Data Bits	7/8
Parity	None/Even/Odd/Mark/Space
Stop Bits	1/2
Flow Control	None/Hardware RTS/CTS
VT-UTF8 Combo Key Support	Enabled/Disabled
Recorder Mode	Disabled/Enabled
Resolution 100x31	Disabled/Enabled
Putty KeyPad	VT100/LINUX/XTERMR6/SCO/ESCN/VT400

8.3.8.4 COM3 Console Redirection Settings

Aptio Setup Utility - Copyright (C) 2020 American Megatrends, Inc.
 Main **Advanced** Chipset Security Boot Save & Exit

COM3 Console Redirection Settings Terminal Type [ANSI] Bits per second [115200] Data Bits [8] Parity [None] Stop Bits [1] Flow Control [None] VT-UTF8 Combo Key Support [Enabled] Recorder Mode [Disabled] Resolution 100x31 [Disabled] Putty KeyPad [VT100]	Emulation: ANSI: Extended ASCII char set. VT100: ASCII char set. VT100+: Extends VT100 to support color, function keys, etc. VT-UTF8: Uses UTF8 encoding to map Unicode chars onto 1 or more bytes. ←: Select Screen ↑↓: Select Item Enter: Select +/-: Change Opt. F1: General Help F2: Previous Values F3: Optimized Defaults F4: Save & Reset ESC: Exit
---	---

Version 2.20.1275. Copyright (C) 2020 American Megatrends, Inc.

Bios-Eintrag	Optionen
COM3	
Console Redirection Settings	
Serial Port Terminal Type	VT100/VT100+/VT-UTF8/ANSI
Bits per second	9600/19200/38400/57600/115200
Data Bits	7/8
Parity	None/Even/Odd/Mark/Space
Stop Bits	1/2
Flow Control	None/Hardware RTS/CTS
VT-UTF8 Combo Key Support	Enabled/Disabled
Recorder Mode	Disabled/Enabled
Resolution 100x31	Disabled/Enabled
Putty KeyPad	VT100/LINUX/XTERMR6/SCO/ESCN/VT400

8.3.9 AMI Graphic Output Protocol Policy

Aptio Setup Utility - Copyright (C) 2020 American Megatrends, Inc.

Advanced

Intel(R) Graphics Controller Intel(R) GOP Driver [9.0.1105] Output Select [DVI3]	Output Interface →: Select Screen ↑↓: Select Item Enter: Select +/-: Change Opt. F1: General Help F2: Previous Values F3: Optimized Defaults F4: Save & Reset ESC: Exit
--	--

Version 2.20.1275. Copyright (C) 2020 American Megatrends, Inc.

Bios-Eintrag	Optionen
Intel® Graphics Controller Intel® GOP Driver [9.0.1105]	
Output Select	Keine

8.3.10 PCI Subsystem Settings

Aptio Setup Utility - Copyright (C) 2020 American Megatrends, Inc.

Advanced

<pre> PCI Bus Driver Version A5.01.17 PCI Devices Common Settings: PCI Latency Timer [32 PCI Bus Clocks] PCI-X Latency Timer [64 PCI Bus Clocks] VGA Palette Snoop [Disabled] PERR# Generation [Disabled] SERR# Generation [Disabled] BME DMA Mitigation [Disabled] > PCI Hot-Plug Settings </pre>	<p>Value to be programmed into PCI Latency Timer Register.</p> <hr/> <pre> ←: Select Screen ↑↓: Select Item Enter: Select +/-: Change Opt. F1: General Help F2: Previous Values F3: Optimized Defaults F4: Save & Reset ESC: Exit </pre>
--	--

Version 2.20.1275. Copyright (C) 2020 American Megatrends, Inc.

Bios-Eintrag	Optionen
PCI Bus Driver Version	Keine
PCI Device Common Settings:	
PCI Latency Timer	32/64/96/128/160/192/224/248/PCI Bus Clocks
PCI-X Latency Timer	32/64/96/128/160/192/224/248/PCI Bus Clocks
VGA Palette Snoop	Disabled/Enabled
PERR# Generation	Disabled/Enabled
SERR# Generation	Disabled/Enabled
Above 4G Decoding	Disabled/Enabled
PCI Hot-Plug Settings	Untermenü siehe: PCI Hot-Plug Settings [▶ 54]

8.3.10.1 PCI Hot-Plug Settings

Aptio Setup Utility - Copyright (C) 2020 American Megatrends, Inc.

Advanced

PCI Hot-Plug Settings BIOS Hot-Plug Support [Enabled] PCI Buses Padding [1] I/O Resources Padding [4 K] MMIO 32 bit Resources Padding [16 M] PFMMIO 32 bit Resources Padding [16 M]	If ENABLED allows BIOS build in Hot-Pug support. Use this feature if OS does not support PCI Express and SHPC hot-plug natively. ←: Select Screen ↑↓: Select Item Enter: Select +/-: Change Opt. F1: General Help F2: Previous Values F3: Optimized Defaults F4: Save & Reset ESC: Exit
--	--

Version 2.20.1275. Copyright (C) 2020 American Megatrends, Inc.

Bios-Eintrag	Optionen
PCI Hot-Plug Settings	
BIOS Hot-Plug Support	Enabled/Disabled
PCI Buses Padding	Disabled/1/2/3/4/5
I/O Resources Padding	Disabled/4 K/8 K /16 K/32 K
MMIO 32 bit Resources Padding	Disabled/1 M/2 M/4 M/8 M/16 M/32 M/64 M/128 M
PFMMIO 32 bit Resources Padding	Disabled/1 M/2 M/4 M/8 M/16 M/32 M/64 M/128 M

8.3.11 USB Configuration

Aptio Setup Utility - Copyright (C) 2020 American Megatrends, Inc.

Advanced

<pre> USB Configuration USB Module Version 23 USB Controllers: 1 XHCI USB Devices: None Legacy USB Support [Enabled] XHCI Hand-off [Enabled] USB Mass Storage Driver Support [Enabled] USB hardware delays and time-outs: USB transfer time-out [20 sec] Device reset time-out [20 sec] Device power-up delay [Auto] </pre>	<p>Enables Legacy USB support. AUTO option disables legacy support if no USB devices are connected. DISABLE option will keep USB devices available only for EFI applications.</p> <hr/> <pre> ->: Select Screen ↑↓: Select Item Enter: Select +/-: Change Opt. F1: General Help F2: Previous Values F3: Optimized Defaults F4: Save & Reset ESC: Exit </pre>
--	---

Version 2.20.1275. Copyright (C) 2020 American Megatrends, Inc.

Bios-Eintrag	Optionen
USB Configuration	
USB Module Version	Keine
USB Controllers: 1XHCI	Keine
USB Devices: None	Keine
Legacy USB Support	Enabled/Disabled/Auto
XHCI Hand-off	Enabled/Disabled
USB Mass Storage Driver Support	Enabled/Disabled
USB hardware delays and time-outs:	
USB transfer time-out	1/5/10/20 sec
Device reset time-out	10/20/30/40 sec
Device power-up delay	Auto/Manual

8.3.12 NVMe Configuration

Aptio Setup Utility - Copyright (C) 2020 American Megatrends, Inc.

Advanced

NVMe controller and Drive information No NVME Device Found	→: Select Screen ↑↓: Select Item Enter: Select +/-: Change Opt. F1: General Help F2: Previous Values F3: Optimized Defaults F4: Save & Reset ESC: Exit
---	--

Version 2.20.1275. Copyright (C) 2020 American Megatrends, Inc.

Bios-Eintrag	Optionen
NVMe controller and Drive Information	
No NVME Device Found	Keine

HINWEIS
NVMe Raid 0/1 wird nicht unterstützt.

8.3.13 Power Controller Options

Aptio Setup Utility - Copyright (C) 2020 American Megatrends, Inc.

Advanced

<pre> Bootloader Version 1.01-38 Firmware Version 1.02-33 Mainboard Serial No Mainboard Prod. Date (Week.Year) 33.20 Mainboard BootCount 48 Mainboard Operation Time 5525min (92h) Voltage (Min/Max) 4.90V / 5.10V Temperature (Min/Max) 21'C /33'C ext. USB-Port Voltage [Off in S3-5] int. USB-Port Voltage [Off in S3-5] WDT OSBoot Timeout [Disabled] </pre>	<pre> Select Power line for external USB devices, if powered-down →: Select Screen ↑↓: Select Item Enter: Select +/-: Change Opt. F1: General Help F2: Previous Values F3: Optimized Defaults F4: Save & Reset ESC: Exit </pre>
--	--

Version 2.20.1275. Copyright (C) 2020 American Megatrends, Inc.

Bios-Eintrag	Optionen
Bootloader Version	Keine
Firmware Version	Keine
Mainboard Serial No	Keine
Mainboard Prod. Date (Week.Year)	Keine
Mainboard BootCount	Keine
Mainboard Operation Time	Keine
Voltage (Min/Max)	Keine
Temperature (Min/Max)	Keine
ext. USB-Port Voltage	Off in S3-5/by SCVV
Int. USB-Port Voltage	Off in S3-5/by SCVV
WDT OSBoot Timeout	Disabled/45, 60, 75,...225, 240, 255 Seconds

8.3.14 SATA und RST Configuration

Aptio Setup Utility - Copyright (C) 2020 American Megatrends, Inc.

Advanced

<pre> SATA And RST Configuration SATA Controller(s) [Enabled] SATA Mode Selection [AHCI] SATA Test Mode [Disabled] > Software Feature Mask Configuration Aggressive LPM Support [Disabled] Serial ATA Port 0 Empty Software Preserve Unknown Port 0 [Enabled] Hot Plug [Disabled] Configured as eSATA Hot Plug supported External [Disabled] Spin Up Device [Disabled] SATA Device Type [Hard Disk Drive] SATA Port 0 DevSlp [Disabled] DITO Configuration [Disabled] </pre>	<p>Enable/Disable SATA Device.</p> <hr/> <pre> ←→: Select Screen ↑↓: Select Item Enter: Select +/-: Change Opt. F1: General Help F2: Previous Values F3: Optimized Defaults F4: Save & Reset ESC: Exit </pre>
---	---

Version 2.20.1275. Copyright (C) 2020 American Megatrends, Inc.

Bios-Eintrag	Optionen
SATA And RST Configuration	
SATA Controller(s)	Enabled/Disabled
SATA Mode Selection	AHCI/Intel RST Premium With Intel Optane System Acceleration
SATA Test Mode	Disabled/Enabled
Software Feature Mask Configuration	Untermenü siehe: Software Feature Mask Configuration [▶ 60]
Aggressive LPM Support	Disabled/Enabled
Serial ATA Port 0 - 5	Keine
Software Preserve	Keine
Port 0	Disabled/Enabled
Hot Plug	Disabled/Enabled
Configured as eSATA	Keine
External	Disabled/Enabled
Spin Up Device	Disabled/Enabled
SATA Device Type	HDD/SSD
SATA Port 0 DevSlp	Disabled/Enabled
DITO Configuration	Disabled/Enabled

HINWEIS

Einstellungen an SATA Ports 0 - 5

Die möglichen Einstellungen an den SATA Ports 0 - 5 sind identisch. Daher werden diese in der Darstellung zusammengefasst.

8.3.14.1 Software Feature Mask Configuration

Aptio Setup Utility - Copyright (C) 2020 American Megatrends, Inc.

Advanced

<p>Software Feature Mask Configuration</p> <p>HDD Unlock [Enabled] LED Locate [Enabled] RAID0 [Enabled] RAID1 [Enabled] RAID10 [Enabled] RAID5 [Enabled] Intel Rapid Recovery Technology [Enabled] OROM UI and BANNER [Enabled] IRRT Only on eSATA [Enabled] Smart Response Technology [Enabled] OROM UI Normal Delay [Enabled] RST Force Form [Enabled] System Acceleration with Intel(R) [Enabled] OPTANE(TM) MEMORY [Enabled] CPU Attached Storage [Enabled]</p>	<p>If enabled, indicates that the HDD password unlock in the OS is enabled.</p> <p>←: Select Screen ↑↓: Select Item Enter: Select +/-: Change Opt. F1: General Help F2: Previous Values F3: Optimized Defaults F4: Save & Reset ESC: Exit</p>
---	---

Version 2.20.1275. Copyright (C) 2020 American Megatrends, Inc.

Bios-Eintrag	Optionen
Software Feature Mask Configuration	
HDD Unlock	Enabled/Disabled
LED Locate	Enabled/Disabled
RAID0	Enabled/Disabled
RAID1	Enabled/Disabled
RAID10	Enabled/Disabled
RAID5	Enabled/Disabled
Intel Rapid Recovery Technology	Enabled/Disabled
OROM UI and BANNER	Enabled/Disabled
IRRT Only on eSATA	Enabled/Disabled
Smart Response Technology	Enabled/Disabled
OROM UI Normal Delay	2, 4, 6, 8 secs
RST Force Form	Disabled/Enabled
System Acceleration with Intel(R)	Enabled/Disabled
Optane (TM) Memory	
CPU Attached Storage	Enabled/Disabled

8.3.15 AMT Configuration

Aptio Setup Utility - Copyright (C) 2020 American Megatrends, Inc.

Advanced

ASF support [Enabled] USB Provisioning of AMT [Disabled] > CIRA Configuration > ASF Configuration > Secure Erase Configuration > OEM Flags Settings > MEBx Resolution Settings Headlessmode [Disabled]	Enable/Disable Alert Standard Format support. ←: Select Screen ↑↓: Select Item Enter: Select +/-: Change Opt. F1: General Help F2: Previous Values F3: Optimized Defaults F4: Save & Reset ESC: Exit
---	---

Version 2.20.1275. Copyright (C) 2020 American Megatrends, Inc.

Bios-Eintrag	Optionen
ASF Support	Disabled/Enabled
USB Provisioning of AMT	Disabled/Enabled
CIRA Configuration	Untermenü siehe: CIRA Configuration [▶ 62]
ASF Configuration	Untermenü siehe: ASF Configuration [▶ 63]
Secure Erase Configuration	Untermenü siehe: Secure Erase Configuration [▶ 63]
OEM Flags Settings	Untermenü siehe: OEM Flags Settings [▶ 64]
MEBx Resolution Settings	Untermenü siehe: MEBx Resolution Settings [▶ 65]
Headlessmode	Disabled/Enabled

8.3.15.1 CIRA Configuration

Aptio Setup Utility - Copyright (C) 2020 American Megatrends, Inc.

Advanced

Activate Remote Assistance Process [Disabled] CIRA Timeout 0	Trigger CIRA boot Note: Network Access must be activated first from MEBx Setup.
←: Select Screen ↑↓: Select Item Enter: Select +/-: Change Opt. F1: General Help F2: Previous Values F3: Optimized Defaults F4: Save & Reset ESC: Exit	

Version 2.20.1275. Copyright (C) 2020 American Megatrends, Inc.

Bios-Eintrag	Optionen
Activate Remote Assistance Process	Disabled/Enabled
CIRA Timeout	Keine

8.3.15.2 ASF Configuration

Aptio Setup Utility - Copyright (C) 2020 American Megatrends, Inc.

Advanced

PET Progress WatchDog OS Timer BIOS Timer ASF Sensors Table	[Enabled] [Disabled] 0 0 [Disabled]	Enable/Disable PET Events Progress to receive PET Events. ←: Select Screen ↑↓: Select Item Enter: Select +/-: Change Opt. F1: General Help F2: Previous Values F3: Optimized Defaults F4: Save & Reset ESC: Exit
---	---	---

Version 2.20.1275. Copyright (C) 2020 American Megatrends, Inc.

Bios-Eintrag	Optionen
PET Progress	Enabled/Disabled
WatchDog	Disabled/Enabled
OS Timer	Keine
BIOS Timer	Keine
ASF Sensors Table	Disabled/Enabled

8.3.15.3 Secure Erase Configuration

Aptio Setup Utility - Copyright (C) 2020 American Megatrends, Inc.

Advanced

Secure Erase mode Force Secure Erase	[Simulated] [Disabled]	Change Secure Erase module behavior: Simulated: Performs SE flow without erasing SSD Real: Erase SSD. ←: Select Screen ↑↓: Select Item Enter: Select +/-: Change Opt. F1: General Help F2: Previous Values F3: Optimized Defaults F4: Save & Reset ESC: Exit
---	---------------------------	---

Version 2.20.1275. Copyright (C) 2020 American Megatrends, Inc.

Bios-Eintrag	Optionen
Secure Erase Mode	Simulated/Real
Force Secure Erase	Disabled/Enabled

8.3.15.4 OEM Flags Settings

Aptio Setup Utility - Copyright (C) 2020 American Megatrends, Inc.

Advanced

MEBx hotkey Pressed [Disabled] MEBx Selection Screen [Disabled] Hide Unconfigure ME Confirmation Prompt [Disabled] MEBx OEM Debug Menu Enable [Disabled] Unconfigure ME [Disabled]	OEMFLag Bit 1: Enable automatic MEBx hotkey press.
←: Select Screen ↑↓: Select Item Enter: Select +/-: Change Opt. F1: General Help F2: Previous Values F3: Optimized Defaults F4: Save & Reset ESC: Exit	

Version 2.20.1275. Copyright (C) 2020 American Megatrends, Inc.

Bios-Eintrag	Optionen
MEBx hotkey Pressed	Disabled/Enabled
MEBx Selection Screen	Disabled/Enabled
Hide Unconfigure ME Confirmation Prompt	Disabled/Enabled
MEBx OEM Debug Menu Enable	Disabled/Enabled
Unconfigure ME	Disabled/Enabled

8.3.15.5 MEBx Resolution Settings

Aptio Setup Utility - Copyright (C) 2020 American Megatrends, Inc.

Advanced

Non-UI Mode Resolution [Auto] UI Mode Resolution [Auto] Graphics Mode Resolution [Auto]		Resolution for non-UI text mode. ←: Select Screen ↑↓: Select Item Enter: Select +/-: Change Opt. F1: General Help F2: Previous Values F3: Optimized Defaults F4: Save & Reset ESC: Exit
---	--	--

Version 2.20.1275. Copyright (C) 2020 American Megatrends, Inc.

Bios-Eintrag	Optionen
Non-UI Resolution	Auto/80x25/100x31
UI Mode Resolution	Auto/80x25/100x31
Graphics Mode Resolution	Auto/640x480/800x600/1024x768

8.3.16 TLs Auth Configuration

Aptio Setup Utility - Copyright (C) 2020 American Megatrends, Inc.

Advanced

> Server CA Configuration > Client Cert Configuration	Press <Enter> to configure Server CA. ←: Select Screen ↑↓: Select Item Enter: Select +/-: Change Opt. F1: General Help F2: Previous Values F3: Optimized Defaults F4: Save & Reset ESC: Exit
--	---

Version 2.20.1275. Copyright (C) 2020 American Megatrends, Inc.

Bios-Eintrag	Optionen
Server CA Configuration	Untermenü siehe: Server CA Configuration [▶ 66]
Client Cert Configuration	Keine

8.3.16.1 Server CA Configuration

Aptio Setup Utility - Copyright (C) 2020 American Megatrends, Inc.

Advanced

<pre>> Enroll Cert > Delete Cert</pre>	<pre>Press <Enter> to enroll cert. ←→: Select Screen ↑↓: Select Item Enter: Select +/-: Change Opt. F1: General Help F2: Previous Values F3: Optimized Defaults F4: Save & Reset ESC: Exit</pre>
--	---

Version 2.20.1275. Copyright (C) 2020 American Megatrends, Inc.

Bios-Eintrag	Optionen
Enroll Cert	Untermenü siehe: Enroll Cert [▶ 67]
Delete Cert	keine

8.3.16.1.1 Enroll Cert

Aptio Setup Utility - Copyright (C) 2019 American Megatrends, Inc.

Advanced

<pre>> Enroll Cert Using File Cert GUID > Commit Changes and Exit > Discard Changes and Exit</pre>	<pre>Enroll Cert Using File</pre> <hr/> <pre>><: Select Screen ^v: Select Item Enter: Select +/-: Change Opt. F1: General Help F2: Previous Values F3: Optimized Defaults F4: Save & Reset ESC: Exit</pre>
---	--

Version 2.20.1271. Copyright (C) 2019 American Megatrends, Inc.

Bios-Eintrag	Optionen
Enroll Cert Enroll Cert Using File	Keine
Cert GUID	Keine
Commit Changes and Exit	Keine
Discard Changes and Exit	Keine

8.3.17 Network Stack Configuration

Aptio Setup Utility - Copyright (C) 2020 American Megatrends, Inc.

Advanced

Network Stack [Disabled]	Enable/Disable UEFI Network Stack
	←: Select Screen ↑↓: Select Item Enter: Select +/-: Change Opt. F1: General Help F2: Previous Values F3: Optimized Defaults F4: Save & Reset ESC: Exit

Version 2.20.1275. Copyright (C) 2020 American Megatrends, Inc.

Bios-Eintrag	Optionen
Network Stack	Disabled/Enabled

8.3.18 Network Stack Configuration enabled

Aptio Setup Utility - Copyright (C) 2020 American Megatrends, Inc.

Advanced

<pre> Network Stack [Enabled] Ipv4 PXE Support [Disabled] Ipv4 HTTP Support [Disabled] Ipv6 PXE Support [Disabled] Ipv6 HTTP Support [Disabled] IPSEC Certificate [Enabled] PXE boot wait time 0 Media detect count 1 </pre>	Enable/Disable UEFI Network Stack ←: Select Screen ↑↓: Select Item Enter: Select +/-: Change Opt. F1: General Help F2: Previous Values F3: Optimized Defaults F4: Save & Reset ESC: Exit
---	---

Version 2.20.1275. Copyright (C) 2020 American Megatrends, Inc.

Bios-Eintrag	Optionen
Network Stack	Enabled/Disabled
Ipv4 PXE Support	Disabled/Enabled
Ipv4 HTTP Support	Disabled/Enabled
Ipv6 PXE Support	Disabled/Enabled
Ipv6 HTTP Support	Disabled/Enabled
IPSEC Certificate	Enabled/Disabled
PXE boot wait time	Keine
Media detect count	Keine

HINWEIS

PXE Boot verfügbar
 PXE Boot ist verfügbar wenn Sie Network Stack und Ipv4 PXE support auf „Enable“ stellen.

8.3.19 Intel Rapid Storage Technology

Aptio Setup Utility - Copyright (C) 2020 American Megatrends, Inc.

Advanced

Intel (R) RST 17.8.0.4507 RAID Driver No disks connected to system	→: Select Screen ↑↓: Select Item Enter: Select +/-: Change Opt. F1: General Help F2: Previous Values F3: Optimized Defaults F4: Save & Reset ESC: Exit
---	--

Version 2.20.1275. Copyright (C) 2020 American Megatrends, Inc.

Bios-Eintrag	Optionen
Intel® RST 17.8.0.4507 RAID Driver	
No disks connected to system	Keine

8.3.20 Intel I210 Gigabit Network Connection

Aptio Setup Utility - Copyright (C) 2020 American Megatrends, Inc.

Advanced

<pre> > NIC Configuration Blink LEDs 0 UEFI Driver Intel(R) PRO/1000 Open Source 8.3.10 PCI-E Adapter PBA 000300-000 Device Name Intel(R) I210 Gigabit Network Connection Chip Type Intel i210 PCI Device ID 1533 PCI Address 01:00:00 Link Status [Disconnected] MAC Address 00:01:05:54:49:25 Virtual MAC Address 00:00:00:00:00:00 </pre>	<p>Click to configure the network device port.</p> <hr/> <p>←: Select Screen ↑↓: Select Item Enter: Select +/-: Change Opt. F1: General Help F2: Previous Values F3: Optimized Defaults F4: Save & Reset ESC: Exit</p>
---	--

Version 2.20.1275. Copyright (C) 2020 American Megatrends, Inc.

Bios-Eintrag	Optionen
NIC Configuration	Siehe Untermenü: NIC Configuration [▶ 72]
Blink LEDs	Keine
UEFI Driver	Keine
Adapter PBA	Keine
Device Name	Keine
Chip Type	Keine
PCI Device ID	Keine
PCI Address	Keine
Link Status	Keine
MAC Address	Keine
Virtual MAC Address	Keine

8.3.20.1 NIC Configuration

Aptio Setup Utility - Copyright (C) 2020 American Megatrends, Inc.

Advanced

Link Speed [Auto Negotiated] Wake On LAN [Diasbled]	Specifies the port speed used for the selected boot protocol.
←: Select Screen ↑↓: Select Item Enter: Select +/-: Change Opt. F1: General Help F2: Previous Values F3: Optimized Defaults F4: Save & Reset ESC: Exit	

Version 2.20.1275. Copyright (C) 2020 American Megatrends, Inc.

Bios-Eintrag	Optionen
Link Speed	Auto Negotiated/10 Mbps Half/10 Mbps Full/ 100 Mbps Half/100 Mbps Full
Wake On LAN	Disabled/Enabled

8.3.21 Intel Ethernet Connection(2) I219-LM

Aptio Setup Utility - Copyright (C) 2020 American Megatrends, Inc.

Advanced

<pre> PORT CONFIGURATION MENU > NIC Configuration Blink LEDs 0 PORT CONFIGURATION INFORMATION UEFI Driver Intel(R) Gigabit 0.0.24 Adapter PBA FFFFFFFF-0FF Chip Type Intel PCH SPT PCI Device ID 15B7 PCI Address 00:1F:06 Link Status [Disconnected] MAC Address 00:01:05:54:49:24 </pre>	<p>Click to configure the network device port.</p> <hr/> <p>→: Select Screen ↑↓: Select Item Enter: Select +/-: Change Opt. F1: General Help F2: Previous Values F3: Optimized Defaults F4: Save & Reset ESC: Exit</p>
--	--

Version 2.20.1275. Copyright (C) 2020 American Megatrends, Inc.

Bios-Eintrag	Optionen
PORT CONFIGURATION MENU	
NIC Configuration	Siehe Untermenü: NIC Configuration [▶ 74]
Blink LEDs	Keine
PORT CONFIGURATION INFORMATION	
UEFI Driver	Keine
Adapter PBA	Keine
Chip Type	Keine
PCI Device ID	Keine
PCI Address	Keine
Link Status	Keine
MAC Address	Keine

8.3.21.1 NIC Configuration

Aptio Setup Utility - Copyright (C) 2020 American Megatrends, Inc.

Advanced

Link Speed [Auto Negotiated] Wake On LAN [Diasbled]	Specifies the port speed used for the selected boot protocol.
←: Select Screen ↑↓: Select Item Enter: Select +/-: Change Opt. F1: General Help F2: Previous Values F3: Optimized Defaults F4: Save & Reset ESC: Exit	

Version 2.20.1275. Copyright (C) 2020 American Megatrends, Inc.

Bios-Eintrag	Optionen
Link Speed	Auto Negotiated/10 Mbps Half/10 Mbps Full/ 100 Mbps Half/100 Mbps Full
Wake On LAN	Disabled/Enabled

8.3.22 Driver Health

Aptio Setup Utility - Copyright (C) 2020 American Megatrends, Inc.

Advanced

<pre>> Intel(R) PRO/1000 Open Source 8.3.10 PCI-E Healthy > Intel(R) Gigabit 0.0.24 Healthy</pre>	<p>Provides Health Status for the Drivers/Controllers</p> <hr/> <pre>><: Select Screen ^v: Select Item Enter: Select +/-: Change Opt. F1: General Help F2: Previous Values F3: Optimized Defaults F4: Save & Reset ESC: Exit</pre>
---	--

Version 2.20.1275. Copyright (C) 2020 American Megatrends, Inc.

Bios-Eintrag	Optionen
Intel(R) PRO/1000 Open Source 8.3.10 PCI-E Healthy	Keine
Intel(R) Gigabit 0.0.24 Healthy	Keine

8.4 Chipset

```

Aptio Setup Utility - Copyright (C) 2020 American Megatrends, Inc.
Main  Advanced  Chipset  Security  Boot  Save & Exit

> System Agent (SA) Configuration
> PCH-IO Configuration

System Agent (SA) Parameters

><: Select Screen
^v: Select Item
Enter: Select
+/-: Change Opt.
F1: General Help
F2: Previous Values
F3: Optimized Defaults
F4: Save & Reset
ESC: Exit

Version 2.20.1275. Copyright (C) 2020 American Megatrends, Inc.
    
```

Bios-Eintrag	Optionen
System Agent (SA) Configuration	Untermenü siehe: System Agent (SA) Configuration [► 77]
PCH-IO Configuration	Untermenü siehe: PCH-IO Configuration [► 79]

8.4.1 System Agent (SA) Configuration

Aptio Setup Utility - Copyright (C) 2020 American Megatrends, Inc.
Chipset

System Agent (SA) Configuration SA PCIe Code Version 7.0.112.32 VT-d Supported > Graphics Configuration Stop Grant Configuration [Auto] VT-d [Enabled] CHAP Device (B0:D7:F0) [Disabled] Thermal Device (B0:D4:F0) [Disabled] GNA Device (B0:D8:F0) [Enabled] CRID Support [Disabled] Above 4GB MMIO BIOS assignment [Disabled] X2APIC Opt Out [Disabled] IPU Device (B0:D5:F0) [Disabled]	Memory Configuration Parameters ←: Select Screen ↑↓: Select Item Enter: Select +/-: Change Opt. F1: General Help F2: Previous Values F3: Optimized Defaults F4: Save & Reset ESC: Exit
--	---

Version 2.20.1275. Copyright (C) 2020 American Megatrends, Inc.

Bios-Eintrag	Optionen
System Agent (SA) Configuration	
SA PCIe Code Version	Keine
VT-d	Keine
Graphics Configuration	
Stop Grant Configuration	Auto/Manual
VT-d	Enabled/Disabled
CHAP Device (B0:D7:F0)	Disabled/Enabled
Thermal Device (B0:D4:F0)	Enabled/Disabled
GNA Device (B0:D8:F0)	Enabled/Disabled
CRID Support	Disabled/Enabled
Above 4GB MMIO BIOS assignment	Disabled/Enabled
X2APIC Opt Out	Disabled/Enabled
IPU Device (B0:D5:F0)	Disabled/Enabled

8.4.1.1 Graphics Configuration

Aptio Setup Utility - Copyright (C) 2020 American Megatrends, Inc.
Chipset

Graphics Configuration Graphics Turbo IMON Current 31 Skip Scaning of External Gfx Card [Disabled] Primary Display [Auto] Select PCIE Card [Auto] > External Gfx Card Primary Display Configuration Internal Graphics [Auto] GTT Size [8MB] Aperture Size [256MB] PSMI SUPPORT [Disabled] DVMT Pre-Allocated [32M] DVMT Total Gfx Mem [256M] Intel Graphics Pei Display Peim [Disabled] VDD Enable [Enabled] PM Support [Disabled] PAVP Enable [Enabled] Cdynmax Clamping Enable [Enabled] Cd Clock Frequency [675 Mhz]	Graphics turbo IMON current values supported (14-31) ←: Select Screen ↑↓: Select Item Enter: Select +/-: Change Opt. F1: General Help F2: Previous Values F3: Optimized Defaults F4: Save & Reset ESC: Exit
--	--

Version 2.20.1275. Copyright (C) 2020 American Megatrends, Inc.

Bios-Eintrag	Optionen
Graphics Configuration	
Graphics Turbo IMON Current	Keine
Skip Scaning of External Gfx Card	Disabled/Enabled
Primary Display	Auto/IGFX/PCI/SG
Select PCIE Card	Auto/EIk Creek 4/PEG Eval
External Gfx Card Primary Display Configuration	Keine
Internal Graphics	Auto/Disabled/Enabled
GTT Size	2/4/8 MB
Aperture Size	128/256/512/1024/2048 MB
PSMI SUPPORT	Disabled/Enabled
DVMT Pre-Allocated	0M, 32M...60M
DVMT Total Gfx Mem	128M/256M/MAX
Intel Graphics Pei Display Peim	Disabled/Enabled
VDD Enable	Enabled/Disabled
PM Support	Keine
PAVP Enable	Enabled/Disabled
Cdynmax Clamping Enable	Enabled/Disabled
Cd Clock Frequency	337.5/450/540/675 Mhz

8.4.2 PCH-IO Configuration

Aptio Setup Utility - Copyright (C) 2020 American Megatrends, Inc.
Chipset

<p>PCH-IO Configuration</p> <p>> PCI Express Configuration > USB Configuration > HD Audio Configuration</p> <p>PCH LAN Controller [Enabled] Wake on LAN Enable [Enabled] Second LAN Controller [Enabled]</p> <p>CLKRUN# logic [Enabled] State After G3 [S0 State] Compatible Revision ID [Disabled] Legacy IO Low Latency [Enabled] Enable TCO Timer [Enabled]</p>	<p>PCI Express Configuration settings</p> <p>←: Select Screen ↑↓: Select Item Enter: Select +/-: Change Opt. F1: General Help F2: Previous Values F3: Optimized Defaults F4: Save & Reset ESC: Exit</p>
---	--

Version 2.20.1275. Copyright (C) 2020 American Megatrends, Inc.

BIOS-Eintrag	Optionen
PCH-IO Configuration	
PCI Express Configuration	Untermenü siehe: PCI Express Configuration [▶ 80]
USB Configuration	Untermenü siehe: USB Configuration [▶ 84]
HD Audio Configuration	Untermenü siehe: HD Audio Configuration [▶ 84]
PCH LAN Controller	Enabled/Disabled
Wake on LAN Enable	Enabled/Disabled
Second LAN Controller	Enabled/Disabled
PS_ON Enable	Disabled/Enabled
CLKRUN# logic	Enabled/Disabled
State After G3	S0 State/S5 State
Compatible Revision ID	Keine
Legacy IO Low Latency	Enabled/Disabled
Enable TCO Timer	Disabled/Enabled

8.4.2.1 PCI Express Configuration

Aptio Setup Utility – Copyright (C) 2020 American Megatrends, Inc.
Chipset

<pre> PCI Express Configuration PCI Express Clock Gating [Disabled] PCIe Port assigned to LAN 5 Peer Memory Write Enable [Disabled] Compliance Test Mode [Disabled] PCIe-USB Glitch W/A [Disabled] > PCI Express Root Port 1 > PCI Express Root Port 2 > PCI Express Root Port 3 PCIe Port 5 is assigned to LAN1 PCIe Port 6 is assigned to LAN2 > PCI Express Root Port 9 PCI Express Root Port 10 Shadowed by x2/x4 port PCI Express Root Port 11 Shadowed by x2/x4 port PCI Express Root Port 12 Shadowed by x2/x4 port > PCI Express Root Port 21 PCI Express Root Port 22 Shadowed by x2/x4 port PCI Express Root Port 23 Shadowed by x2/x4 port PCI Express Root Port 24 Shadowed by x2/x4 port </pre>	<p>PCI Express Clock Gating Enable/Disable for each root port.</p> <hr/> <p>←: Select Screen ↑↓: Select Item Enter: Select +/-: Change Opt. F1: General Help F2: Previous Values F3: Optimized Defaults F4: Save & Reset ESC: Exit</p>
--	--

Version 2.20.1275. Copyright (C) 2020 American Megatrends, Inc.

Bios-Eintrag	Optionen
PCI Express Configuration	
PCI Express Clock Gating	Disabled/Enabled
PCIe Port assigned to LAN	Keine
Peer Memory Write Enable	Disabled/Enabled
Compliance Test Mode	Disabled/Enabled
PCIe-USB Glitch W/A	Disabled/Enabled
PCI Express Root Port 1	Untermenü siehe: PCI Express Root Port 1 [▶ 81]
PCI Express Root Port 2	Untermenü siehe: PCI Express Root Port 1 [▶ 81]
PCI Express Root Port 3	Untermenü siehe: PCI Express Root Port 1 [▶ 81]
PCIe Port 5 is assigned to LAN1	Keine
PCIe Port 6 is assigned to LAN2	Keine
PCI Express Root Port 9	Untermenü siehe: PCI Express Root Port 1 [▶ 81]
PCI Express Root Port 10	Keine
PCI Express Root Port 11	Keine
PCI Express Root Port 12	Keine
PCI Express Root Port 21	Untermenü siehe: PCI Express Root Port 1 [▶ 81]
PCI Express Root Port 22	Keine
PCI Express Root Port 23	Keine
PCI Express Root Port 24	Keine

8.4.2.1.1 PCI Express Root Port 1

Aptio Setup Utility - Copyright (C) 2020 American Megatrends, Inc.

Chipset

Aptio Setup Utility - Copyright (C) 2020 American Megatrends, Inc.

<pre> PCI Express Root Port 1 [Enabled] Disable Gen2 P11 Shutdown and L1 [Disabled] Controller Power gating Connection Type [Slot] Gen3 Eq Phase3 Method [Hardware] UPTP 5 DPTP 7 ACS [Enabled] PTM [Enabled] DPC [Enabled] EDPC [Enabled] URR [Disabled] FER [Disabled] NFER [Disabled] CER [Disabled] CTO [Disabled] SEFE [Disabled] SENFE [Enabled] SECE [Disabled] PME SCI [Enabled] Hot Plug [Disabled] Advanced Error Reporting [Enabled] PCIe Speed [Auto] Transmitter Half Swing [Disabled] Detect Timeout 0 Extra Bus Reserved 0 Reserved Memory 10 Reserved I/O 0 PCH PCIe LTR Congguration LTR [Enabled] Snoop Latency Override [Auto] Non Snoop Latency Override [Auto] Force LTR Override [Disabled] LTR Lock [Disabled] >Extra Options </pre>	<pre> Control the PCI Express Root Port. ←→: Select Screen ↑↓: Select Item Enter: Select +/-: Change Opt. F1: General Help F2: Previous Values F3: Optimized Defaults F4: Save & Reset ESC: Exit </pre>
--	--

Version 2.20.1275. Copyright (C) 2020 American Megatrends, Inc.

BIOS-Eintrag	Optionen
PCI Express Root Port 1	Disabled/Enabled
Disable Gen2 Pll Shutdown and L1 and Controller Power gating	Disabled/Enabled
Connection Type	Built-in/Slot
Gen3 Eq Phase3 Method	Hardware/Static Coeff.
UPTP	Keine
DPTP	Keine
ACS	Enabled/Disabled
PTM	Enabled/Disabled
DPC	Enabled/Disabled
EDPC	Enabled/Disabled
URR	Disabled/Enabled
FER	Disabled/Enabled
NFER	Disabled/Enabled
CER	Disabled/Enabled
CTO	Disabled/Enabled
SEFE	Disabled/Enabled
SENF	Disabled/Enabled
PME SCI	Enabled/Disabled
Hot Plug	Disabled/Enabled
Advanced Error Reporting	Enabled/Disabled
PCIe Speed	Auto/Gen1/Gen2/Gen3
Transmitter Half Swing	Disabled/Enabled
Detect Timeout	Keine
Extra Bus Reserved	Keine
Reserved Memory	Keine
Reserved I/O	Keine
PCH PCIe LTR Configuration	
LTR	Enabled/Disabled
Snoop Latency Override	Disbaled/Manual/Auto
Non Snoop Latency Override	Disbaled/Manual/Auto
Force LTR Override	Disabled/Enabled
LTR Lock	
LTR Lock	Disabled/Enabled
Extra Options	
Extra Options	Untermenü siehe: Extra Options [►_83]

HINWEIS

PCI Express Configuration

Die BIOS-Einträge und die Optionen an den Ports 1 – 3; 9, und 21 sind identisch. Beispielhaft ist der Port 1 dargestellt

8.4.2.1.1.1 Extra Options

Aptio Setup Utility - Copyright (C) 2020 American Megatrends, Inc.
Chipset

Detect Non-Compliance Device [Disabled] Prefetchable Memory 10 Reserved Memory Alignment 1 Prefetchable Memory Alignment 1	Detect Non-Compliance PCI Express Device. If enable, it will take more time at POST time.
←: Select Screen ↑↓: Select Item Enter: Select +/-: Change Opt. F1: General Help F2: Previous Values F3: Optimized Defaults F4: Save & Reset ESC: Exit	

Version 2.20.1275. Copyright (C) 2020 American Megatrends, Inc.

BIOS-Eintrag	Optionen
Detect Non-Compliance Device	Disabled/Enabled
Prefetchable Memory	Keine
Reserved Memory Alignment	Keine
Prefetchable Memory Alignment	Keine

8.4.2.2 USB Configuration

Aptio Setup Utility - Copyright (C) 2020 American Megatrends, Inc.
Chipset

USB Configuration XHCI Compliance Mode [Disabled] USB Port Disable Override [Disable Link]	Option to enable Compliance Mode. Default is to disable Compliance Mode. Change to enabled for Compliance Mode testing. ←: Select Screen ↑↓: Select Item Enter: Select +/-: Change Opt. F1: General Help F2: Previous Values F3: Optimized Defaults F4: Save & Reset ESC: Exit
--	---

Version 2.20.1275. Copyright (C) 2020 American Megatrends, Inc.

BIOS-Eintrag	Optionen
USB Configuration	
XHCI Compliance Mode	Disabled/Enabled
USB Port Disable Override	Disable Link/Select Per-Pin

8.4.2.3 HD Audio Configuration

Aptio Setup Utility - Copyright (C) 2020 American Megatrends, Inc.
Chipset

HD Audio Subsystem Configuration Settings HD Audio [Enabled]	Control Detection of the HD-Audio device. Disabled = HDA will be unconditionally disabled Enabled = HDA will be unconditionally enabled. ←: Select Screen ↑↓: Select Item Enter: Select +/-: Change Opt. F1: General Help F2: Previous Values F3: Optimized Defaults F4: Save & Reset ESC: Exit
---	--

Version 2.20.1275. Copyright (C) 2020 American Megatrends, Inc.

Bios-Eintrag	Optionen
HD Audio Subsystem Configuration Settings	
HD Audio	Enabled/Disabled

8.5 Security

Aptio Setup Utility - Copyright (C) 2020 American Megatrends, Inc.
Main Advanced Chipset **Security** Boot Save & Exit

Password Description Minimum length 3 Maximum length 20 Administrator Password User Mode available [Enabled] > Secure Boot	Set Administrator Password ←→<: Select Screen ↑↓: Select Item Enter: Select +/-: Change Opt. F1: General Help F2: Previous Values F3: Optimized Defaults F4: Save & Reset ESC: Exit
---	--

Version 2.20.1275. Copyright (C) 2020 American Megatrends, Inc.

Setup-Eintrag	Optionen
Password Description	
Minimum length	Keine
Maximum length	Keine
Administrator Password	Hier können Sie ein Administrator-Passwort setzen.
User Mode available	Enabled/Disabled
Secure Boot	Untermenü siehe: Secure Boot [▶ 86]

8.5.1 Secure Boot

Aptio Setup Utility - Copyright (C) 2020 American Megatrends, Inc.
Security

System Mode Secure Boot Secure Boot Mode > Restore Factory Keys > Reset To Setup Mode > Key Management	Setup [Disabled] Not Active [Custom]	Secure Boot feature is Active if Secure Boot is Enabled, Platform Key(PK) is enrolled and the System is in User mode. The mode change requires platform reset ←: Select Screen ↑↓: Select Item Enter: Select +/-: Change Opt. F1: General Help F2: Previous Values F3: Optimized Defaults F4: Save & Reset ESC: Exit
---	---	---

Version 2.20.1275. Copyright (C) 2020 American Megatrends, Inc.

Bios-Eintrag	Optionen
System Mode	Keine
Secure Boot	Disabled/Enabled Not Active
Secure Boot Mode	Custom/Standard
Restore Factory Keys	Untermenü siehe: Restore Factory Keys [▶ 87]
Reset To Setup Mode	Untermenü siehe: Reset To Setup Mode [▶ 88]
Key Management	Untermenü siehe: Key Management [▶ 89]

8.5.1.1 Restore Factory Keys

Aptio Setup Utility - Copyright (C) 2020 American Megatrends, Inc.
Security

System Mode Secure Boot Secure Boot Mode > Restore Factory Keys > Reset To Setup Mode > Key Management	User [Disabled] Not Active [Custom]	Force System to User Mode. Install factory default Secure Boot key databases Install factory defaults Press 'Yes' to proceed 'No' to cancel _____ Yes No
---	--	---

elect Screen
elect Item
: Select
Change Opt.
F1: General Help
F2: Previous Values
F3: Optimized Defaults
F4: Save & Reset
ESC: Exit

Version 2.20.1275. Copyright (C) 2020 American Megatrends, Inc.

Bios-Eintrag	Optionen
System Mode	Keine
Secure Boot	Disabled/Enabled
Secure Boot Mode	Custom/Standard
Restore Factory Keys	Install factory defaults, siehe Kasten

8.5.1.2 Reset To Setup Mode

Aptio Setup Utility - Copyright (C) 2020 American Megatrends, Inc.
Security

System Mode Secure Boot Secure Boot Mode > Restore Factory Keys > Reset To Setup Mode > Key Management	User [Disabled] Not Active [Custom] Reset To Setup Mode	Delete all Secure Boot key databases from NVRAM elect Screen elect Item : Select Change Opt. eneral Help F2: Previous Values F3: Optimized Defaults F4: Save & Reset ESC: Exit
---	---	---

Deleting all variables will reset the System to Setup Mode
Do you want to proceed?

Yes No

Version 2.20.1275. Copyright (C) 2020 American Megatrends, Inc.

Bios-Eintrag	Optionen
System Mode	Keine
Secure Boot	Disabled/Enabled Not Active
Secure Boot Mode	Custom/Standard
Reset To Setup Mode	Reset To Setup Mode (siehe Kasten)

8.5.1.3 Key Management

Aptio Setup Utility - Copyright (C) 2020 American Megatrends, Inc.
Security

<p>Vendor Keys Modified</p> <p>Factory Key Provision [Disabled]</p> <p>> Restore Factory Keys</p> <p>> Reset To Setup Mode</p> <p>> Export Secure Boot variables</p> <p>> Enroll Efi Image</p> <p>Device Guard Ready</p> <p>> Remove 'UEFI CA' from DB</p> <p>> Restore DB defaults</p> <table style="width: 100%; border-collapse: collapse;"> <tr> <td style="border-right: 1px solid black;">Secure Boot variable</td> <td style="border-right: 1px solid black;">Size</td> <td style="border-right: 1px solid black;">Keys</td> <td>Key Source</td> </tr> <tr> <td style="border-right: 1px solid black;">> Platform Key(PK)</td> <td style="border-right: 1px solid black;">862</td> <td style="border-right: 1px solid black;">1</td> <td>Test (AMI)</td> </tr> <tr> <td style="border-right: 1px solid black;">> Key Exchange Keys</td> <td style="border-right: 1px solid black;">1560</td> <td style="border-right: 1px solid black;">1</td> <td>Factory</td> </tr> <tr> <td style="border-right: 1px solid black;">> Authorized Signatures</td> <td style="border-right: 1px solid black;">3143</td> <td style="border-right: 1px solid black;">2</td> <td>Factory</td> </tr> <tr> <td style="border-right: 1px solid black;">> Forbidden Signatures</td> <td style="border-right: 1px solid black;">3724</td> <td style="border-right: 1px solid black;">77</td> <td>Factory</td> </tr> <tr> <td style="border-right: 1px solid black;">> Authorized TimeStamps</td> <td style="border-right: 1px solid black;">0</td> <td style="border-right: 1px solid black;">0</td> <td>No Keys</td> </tr> <tr> <td style="border-right: 1px solid black;">> OsRecovery Signatures</td> <td style="border-right: 1px solid black;">0</td> <td style="border-right: 1px solid black;">0</td> <td>No Keys</td> </tr> </table>	Secure Boot variable	Size	Keys	Key Source	> Platform Key(PK)	862	1	Test (AMI)	> Key Exchange Keys	1560	1	Factory	> Authorized Signatures	3143	2	Factory	> Forbidden Signatures	3724	77	Factory	> Authorized TimeStamps	0	0	No Keys	> OsRecovery Signatures	0	0	No Keys	<p>Install factory default Secure Boot keys after the platform reset and while the System is in Setup mode</p> <hr/> <p>←: Select Screen ↑↓: Select Item Enter: Select +/-: Change Opt. F1: General Help F2: Previous Values F3: Optimized Defaults F4: Save & Reset ESC: Exit</p>
Secure Boot variable	Size	Keys	Key Source																										
> Platform Key(PK)	862	1	Test (AMI)																										
> Key Exchange Keys	1560	1	Factory																										
> Authorized Signatures	3143	2	Factory																										
> Forbidden Signatures	3724	77	Factory																										
> Authorized TimeStamps	0	0	No Keys																										
> OsRecovery Signatures	0	0	No Keys																										

Version 2.20.1275. Copyright (C) 2020 American Megatrends, Inc.

Bios-Eintrag	Optionen
Vendor Keys	Keine
Factory Key Provision	Disabled/Enabled
Restore Factory Keys	Untermenü siehe: Restore Factory Keys [► 90]
Reset To Setup Mode	Untermenü siehe: Reset To Setup Mode [► 91]
Export Secure Boot variables	Untermenü siehe: Export Secure Boot Variables [► 92]
Enroll Efi Image	Untermenü siehe: Enroll Efi Image [► 93]
Device Guard Ready	
Remove 'UEFI CA' from DB	Untermenü siehe: Remove UEFI CA from DB [► 93]
Restore DB defaults	Untermenü siehe: Restore DB Defaults [► 94]
Secure Boot variables	Eingabetaste drücken
PlatformKey(PK)	Eingabetaste drücken
Key Exchange Keys	Eingabetaste drücken
Authorized Signatures	Eingabetaste drücken
Forbidden Signatures	Eingabetaste drücken
Authorized TimeStamps	Eingabetaste drücken
OsRecovery Signatures	Eingabetaste drücken

8.5.1.3.1 Restore Factory Keys

Aptio Setup Utility - Copyright (C) 2020 American Megatrends, Inc.
Security

<p>Vendor Keys Modified</p> <p>Factory Key Provision [Disabled]</p> <p>> Restore Factory Keys</p> <p>> Reset To Setup Mode</p> <p>> Export Secure Boot variables</p> <p>> Enroll Efi Image</p> <p>Device Guard Ready</p> <p>> Remove 'UEFI CA' from DB</p> <p>> Restore DB defaults</p> <table style="width: 100%; border-collapse: collapse;"> <tr> <td style="width: 20%;">Secure Boot variable</td> <td style="width: 10%;">Siz</td> <td style="width: 10%;"></td> <td style="width: 10%;"></td> <td style="width: 10%;"></td> <td style="width: 10%;"></td> <td style="width: 10%;"></td> <td style="width: 10%;"></td> <td style="width: 10%;"></td> <td style="width: 10%;"></td> </tr> <tr> <td>> Platform Key (PK)</td> <td>86</td> <td></td> <td></td> <td></td> <td></td> <td></td> <td></td> <td></td> <td></td> </tr> <tr> <td>> Key Exchange Keys</td> <td>156</td> <td></td> <td></td> <td></td> <td></td> <td></td> <td></td> <td></td> <td></td> </tr> <tr> <td>> Authorized Signatures</td> <td>314</td> <td></td> <td></td> <td></td> <td></td> <td></td> <td></td> <td></td> <td></td> </tr> <tr> <td>> Forbidden Signatures</td> <td>3724</td> <td></td> <td></td> <td></td> <td></td> <td></td> <td></td> <td></td> <td></td> </tr> <tr> <td>> Authorized TimeStamps</td> <td>0</td> <td>0</td> <td>No Keys</td> <td></td> <td></td> <td></td> <td></td> <td></td> <td></td> </tr> <tr> <td>> OsRecovery Signatures</td> <td>0</td> <td>0</td> <td>No Keys</td> <td></td> <td></td> <td></td> <td></td> <td></td> <td></td> </tr> </table>	Secure Boot variable	Siz									> Platform Key (PK)	86									> Key Exchange Keys	156									> Authorized Signatures	314									> Forbidden Signatures	3724									> Authorized TimeStamps	0	0	No Keys							> OsRecovery Signatures	0	0	No Keys							<p>Force System to User Mode. Install factory default Secure Boot key databases</p> <p style="text-align: center;">Install factory defaults</p> <p style="text-align: center;">Press 'Yes' to proceed 'No' to cancel</p> <table style="width: 100%; border-collapse: collapse;"> <tr> <td style="width: 50%; text-align: center;">Yes</td> <td style="width: 50%; text-align: center;">No</td> </tr> </table> <p>elect Screen elect Item : Select Change Opt. F1: General Help F2: Previous Values F3: Optimized Defaults F4: Save & Reset ESC: Exit</p>	Yes	No
Secure Boot variable	Siz																																																																								
> Platform Key (PK)	86																																																																								
> Key Exchange Keys	156																																																																								
> Authorized Signatures	314																																																																								
> Forbidden Signatures	3724																																																																								
> Authorized TimeStamps	0	0	No Keys																																																																						
> OsRecovery Signatures	0	0	No Keys																																																																						
Yes	No																																																																								

Version 2.20.1275. Copyright (C) 2020 American Megatrends, Inc.

Bios-Eintrag	Optionen
Vendor Keys	Keine
Restore Factory Keys	Install factory defaults, siehe Kasten

8.5.1.3.2 Reset To Setup Mode

```

Aptio Setup Utility - Copyright (C) 2020 American Megatrends, Inc.
Security

Vendor Keys Modified Delete all Secure Boot key
                        databases from NVRAM

Factory Key Provision [Disabled]

> Restore Factory Keys
> Reset To Setup Mode
> Export Secure Boot variables
> Enroll Efi Image

Device Guard Ready
> Remove 'UEFI CA' from DB
> Restore DB defaults

Secure Boot variable | Siz
> Platform Key(PK)    | 86
> Key Exchange Keys  | 156
> Authorized Signatures | 314
> Forbidden Signatures | 372
> Authorized TimeStamps | 0
> OsRecovery Signatures | 0 | 0 | No Keys

Reset To Setup Mode
Deleting all variables will reset the
System to Setup Mode
Do you want to proceed?

Yes No

elect Screen
elect Item
: Select
Change Opt.
eneral Help
F2: Previous Values
F3: Optimized Defaults
F4: Save & Reset
ESC: Exit

Version 2.20.1275. Copyright (C) 2020 American Megatrends, Inc.
    
```

Bios-Eintrag	Optionen
Vendor Keys	Keine
Reset To Setup Mode	Reset To Setup Mode, siehe Kasten

8.5.1.3.3 Export Secure Boot Variables

Aptio Setup Utility - Copyright (C) 2020 American Megatrends, Inc.
Security

<pre> Vendor Keys Modified Factory Key Provision [Disabled] > Restore Factory Keys > Reset To Setup Mode > Export Secure Boot variables > Enroll Efi Image Device Guard Ready > Remove 'UEFI CA' from DB > Restore DB defaults Secure Boot variable Size K > Platform Key(PK) 862 > Key Exchange Keys 1560 > Authorized Signatures 3143 > Forbidden Signatures 3724 7 > Authorized TimeStamps 0 0 No Keys > OsRecovery Signatures 0 0 No Keys </pre>	<p>Copy NVRAM content of Secure Boot variables to files in a root folder on a file system device</p> <p style="text-align: center;">File System</p> <p style="text-align: center;">No Valid File System Available</p> <p style="text-align: center;">Ok</p> <p>: Select Screen : Select Item ter: Select -: Change Opt. F1: General Help F2: Previous Values F3: Optimized Defaults F4: Save & Reset ESC: Exit</p>
--	--

Version 2.20.1275. Copyright (C) 2020 American Megatrends, Inc.

Bios-Eintrag	Optionen
Vendor Keys	Keine
Export Secure Boot Variables	File System, siehe Kasten

8.5.1.3.4 Enroll Efi Image

Aptio Setup Utility - Copyright (C) 2020 American Megatrends, Inc.
Security

<p>Vendor Keys Modified</p> <p>Factory Key Provision [Disabled]</p> <p>> Restore Factory Keys</p> <p>> Reset To Setup Mode</p> <p>> Export Secure Boot variables</p> <p>> Enroll Efi Image</p> <p>Device Guard Ready</p> <p>> Remove 'UEFI CA' from DB</p> <p>> Restore DB defaults</p> <table border="1"> <tr> <td>Secure Boot variable</td> <td>Size</td> <td>K</td> <td></td> </tr> <tr> <td>> Platform Key (PK)</td> <td>862</td> <td></td> <td></td> </tr> <tr> <td>> Key Exchange Keys</td> <td>1560</td> <td></td> <td></td> </tr> <tr> <td>> Authorized Signatures</td> <td>3143</td> <td></td> <td></td> </tr> <tr> <td>> Forbidden Signatures</td> <td>3724</td> <td>7</td> <td></td> </tr> <tr> <td>> Authorized TimeStamps</td> <td>0</td> <td>0</td> <td>No Keys</td> </tr> <tr> <td>> OsRecovery Signatures</td> <td>0</td> <td>0</td> <td>No Keys</td> </tr> </table>	Secure Boot variable	Size	K		> Platform Key (PK)	862			> Key Exchange Keys	1560			> Authorized Signatures	3143			> Forbidden Signatures	3724	7		> Authorized TimeStamps	0	0	No Keys	> OsRecovery Signatures	0	0	No Keys	<p>File System</p> <p>No Valid File System Available</p> <p>Ok</p>	<p>Copy NVRAM content of Secure Boot variables to files in a root folder on a file system device</p> <p>: Select Screen</p> <p>: Select Item</p> <p>ter: Select</p> <p> -: Change Opt.</p> <p>F1: General Help</p> <p>F2: Previous Values</p> <p>F3: Optimized Defaults</p> <p>F4: Save & Reset</p> <p>ESC: Exit</p>
Secure Boot variable	Size	K																												
> Platform Key (PK)	862																													
> Key Exchange Keys	1560																													
> Authorized Signatures	3143																													
> Forbidden Signatures	3724	7																												
> Authorized TimeStamps	0	0	No Keys																											
> OsRecovery Signatures	0	0	No Keys																											

Version 2.20.1275. Copyright (C) 2020 American Megatrends, Inc.

Bios-Eintrag	Optionen
Vendor Keys	Keine
Enroll Efi Image	File System, siehe Kasten

8.5.1.3.5 Remove UEFI CA from DB

Aptio Setup Utility - Copyright (C) 2020 American Megatrends, Inc.
Security

<p>Vendor Keys Modified</p> <p>Factory Key Provision [Disabled]</p> <p>> Restore Factory Keys</p> <p>> Reset To Setup Mode</p> <p>> Export Secure Boot variables</p> <p>> Enroll Efi Image</p> <p>Device Guard Ready</p> <p>> Remove 'UEFI CA' from DB</p> <p>> Restore DB defaults</p> <table border="1"> <tr> <td>Secure Boot variable</td> <td>Size</td> <td></td> <td></td> </tr> <tr> <td>> Platform Key (PK)</td> <td>86</td> <td></td> <td></td> </tr> <tr> <td>> Key Exchange Keys</td> <td>156</td> <td></td> <td></td> </tr> <tr> <td>> Authorized Signatures</td> <td>314</td> <td></td> <td></td> </tr> <tr> <td>> Forbidden Signatures</td> <td>3724</td> <td></td> <td></td> </tr> <tr> <td>> Authorized TimeStamps</td> <td>0</td> <td>0</td> <td>No Keys</td> </tr> <tr> <td>> OsRecovery Signatures</td> <td>0</td> <td>0</td> <td>No Keys</td> </tr> </table>	Secure Boot variable	Size			> Platform Key (PK)	86			> Key Exchange Keys	156			> Authorized Signatures	314			> Forbidden Signatures	3724			> Authorized TimeStamps	0	0	No Keys	> OsRecovery Signatures	0	0	No Keys	<p>Remove 'UEFI CA' from DB</p> <p>Press 'Yes' to proceed 'No' to cancel</p> <p>Yes No</p>	<p>Device Guard ready system must not list 'Microsoft UEFI CA' Certificate in Authorized Signature database (db)</p> <p>elect Screen</p> <p>elect Item</p> <p>: Select</p> <p>Change Opt.</p> <p>F1: General Help</p> <p>F2: Previous Values</p> <p>F3: Optimized Defaults</p> <p>F4: Save & Reset</p> <p>ESC: Exit</p>
Secure Boot variable	Size																													
> Platform Key (PK)	86																													
> Key Exchange Keys	156																													
> Authorized Signatures	314																													
> Forbidden Signatures	3724																													
> Authorized TimeStamps	0	0	No Keys																											
> OsRecovery Signatures	0	0	No Keys																											

Version 2.20.1275. Copyright (C) 2020 American Megatrends, Inc.

Bios-Eintrag	Optionen
Vendor Keys	Keine
Remove 'UEFI CA' from DB	Remove 'UEFI CA' from DB, siehe Kasten

8.5.1.3.6 Restore DB Defaults

Aptio Setup Utility - Copyright (C) 2020 American Megatrends, Inc.
Security

<pre> Vendor Keys Modified Factory Key Provision [Disabled] > Restore Factory Keys > Reset To Setup Mode > Export Secure Boot variables > Enroll Efi Image Device Guard Ready > Remove 'UEFI CA' from DB > Restore DB defaults Secure Boot variable Siz > Platform Key(PK) 86 > Key Exchange Keys 156 > Authorized Signatures 314 > Forbidden Signatures 3724 > Authorized TimeStamps 0 0 No Keys > OsRecovery Signatures 0 0 No Keys </pre>	<p>Restore DB variable to factory defaults</p> <hr/> <p>Restore DB defaults</p> <p>Press 'Yes' to proceed 'No' to cancel</p> <table style="width: 100%; border: none;"> <tr> <td style="border: none; width: 50%; text-align: center;">Yes</td> <td style="border: none; width: 50%; text-align: center;">No</td> </tr> </table> <hr/> <p> elect Screen elect Item : Select Change Opt. F1: General Help F2: Previous Values F3: Optimized Defaults F4: Save & Reset ESC: Exit </p>	Yes	No
Yes	No		

Version 2.20.1275. Copyright (C) 2020 American Megatrends, Inc.

Bios-Eintrag	Optionen
Vendor Keys	Keine
Restore DB defaults	Restore defaults, siehe Kasten

8.5.1.3.7 Platform Key (PK)

Aptio Setup Utility - Copyright (C) 2020 American Megatrends, Inc.
Security

<p>Vendor Keys Modified</p> <p>Factory Key Provision [Disabled]</p> <p>> Restore Factory Keys</p> <p>> Reset To Setup Mode</p> <p>> Export Secure Boot variables</p> <p>> Enroll Efi Image</p> <p>Device Guard Ready</p> <p>> Remove 'UEFI CA' from DB</p> <p>> Restore DB defaults</p> <table border="1" style="width: 100%; border-collapse: collapse; margin-top: 10px;"> <tr> <th colspan="4" style="text-align: center;">Platform Key (PK)</th> </tr> <tr> <td colspan="4" style="text-align: center;">Details</td> </tr> <tr> <td colspan="4" style="text-align: center;">Export</td> </tr> <tr> <td colspan="4" style="text-align: center;">Update</td> </tr> <tr> <td colspan="4" style="text-align: center;">Delete</td> </tr> </table> <table border="1" style="width: 100%; border-collapse: collapse; margin-top: 10px;"> <thead> <tr> <th style="text-align: left;">Secure Boot variable</th> <th style="text-align: left;">Size</th> <th style="text-align: left;">Ke</th> <th style="text-align: left;">Ke</th> </tr> </thead> <tbody> <tr> <td>> Platform Key (PK)</td> <td>862</td> <td></td> <td></td> </tr> <tr> <td>> Key Exchange Keys</td> <td>1560</td> <td></td> <td></td> </tr> <tr> <td>> Authorized Signatures</td> <td>3143</td> <td>2</td> <td>Factory</td> </tr> <tr> <td>> Forbidden Signatures</td> <td>3724</td> <td>77</td> <td>Factory</td> </tr> <tr> <td>> Authorized TimeStamps</td> <td>0</td> <td>0</td> <td>No Keys</td> </tr> <tr> <td>> OsRecovery Signatures</td> <td>0</td> <td>0</td> <td>No Keys</td> </tr> </tbody> </table>	Platform Key (PK)				Details				Export				Update				Delete				Secure Boot variable	Size	Ke	Ke	> Platform Key (PK)	862			> Key Exchange Keys	1560			> Authorized Signatures	3143	2	Factory	> Forbidden Signatures	3724	77	Factory	> Authorized TimeStamps	0	0	No Keys	> OsRecovery Signatures	0	0	No Keys	<p>Enroll Factory Defaults or load certificates from a file:</p> <p>1.Public Key Certificate:</p> <p>a)EFI_SIGNATURE_LIST</p> <p>b)EFI_CERT_X509 (DER)</p> <p>c)EFI_CERT_RSA2048 (bin)</p> <p>d)EFI_CERT_SHAXXX</p> <p>2.Authenticated UEFI Variable</p> <p>3.EFI PE/COFF Image(SHA256)</p> <p>Key Source:</p> <p>Factory,External,Mixed</p> <hr/> <p>←: Select Screen</p> <p>↑↓: Select Item</p> <p>Enter: Select</p> <p>+/-: Change Opt.</p> <p>F1: General Help</p> <p>F2: Previous Values</p> <p>F3: Optimized Defaults</p> <p>F4: Save & Reset</p> <p>ESC: Exit</p>
Platform Key (PK)																																																	
Details																																																	
Export																																																	
Update																																																	
Delete																																																	
Secure Boot variable	Size	Ke	Ke																																														
> Platform Key (PK)	862																																																
> Key Exchange Keys	1560																																																
> Authorized Signatures	3143	2	Factory																																														
> Forbidden Signatures	3724	77	Factory																																														
> Authorized TimeStamps	0	0	No Keys																																														
> OsRecovery Signatures	0	0	No Keys																																														

Version 2.20.1275. Copyright (C) 2020 American Megatrends, Inc.

Bios-Eintrag	Optionen
Vendor Keys	Keine
Platform Key (PK)	Platform Key (PK), siehe Kasten

8.5.1.3.8 Key Exchange Keys

Aptio Setup Utility - Copyright (C) 2020 American Megatrends, Inc.
Security

<p>Vendor Keys Modified</p> <p>Factory Key Provision [Disabled]</p> <p>> Restore Factory Keys</p> <p>> Reset To Setup Mode</p> <p>> Export Secure Boot variables</p> <p>> Enroll Efi Image</p> <p>Device Guard Ready</p> <p>> Remove 'UEFI CA' from DB</p> <p>> Restore DB defaults</p> <table style="width: 100%; border-collapse: collapse;"> <tr> <td style="width: 30%;">Secure Boot variable</td> <td style="width: 10%;">Size</td> <td style="width: 10%;">Ke</td> <td style="width: 10%;"></td> <td style="width: 10%;"></td> <td style="width: 10%;"></td> <td style="width: 10%;"></td> </tr> <tr> <td>> Platform Key(PK)</td> <td>862</td> <td></td> <td></td> <td></td> <td></td> <td></td> </tr> <tr> <td>> Key Exchange Keys</td> <td>1560</td> <td></td> <td></td> <td></td> <td></td> <td></td> </tr> <tr> <td>> Authorized Signatures</td> <td>3143</td> <td></td> <td></td> <td></td> <td></td> <td></td> </tr> <tr> <td>> Forbidden Signatures</td> <td>3724</td> <td>77</td> <td>Factory</td> <td></td> <td></td> <td></td> </tr> <tr> <td>> Authorized TimeStamps</td> <td>0</td> <td>0</td> <td>No Keys</td> <td></td> <td></td> <td></td> </tr> <tr> <td>> OsRecovery Signatures</td> <td>0</td> <td>0</td> <td>No Keys</td> <td></td> <td></td> <td></td> </tr> </table>	Secure Boot variable	Size	Ke					> Platform Key(PK)	862						> Key Exchange Keys	1560						> Authorized Signatures	3143						> Forbidden Signatures	3724	77	Factory				> Authorized TimeStamps	0	0	No Keys				> OsRecovery Signatures	0	0	No Keys				<div style="border: 1px solid black; padding: 5px; margin-bottom: 10px;"> <p style="text-align: center;">Key Exchange Keys</p> <hr/> <p>Details</p> <p>Export</p> <p>Update</p> <p>Append</p> <p>Delete</p> </div> <p>Enroll Factory Defaults or load certificates from a file:</p> <ol style="list-style-type: none"> 1.Public Key Certificate: <ol style="list-style-type: none"> a)EFI_SIGNATURE_LIST b)EFI_CERT_X509 (DER) c)EFI_CERT_RSA2048 (bin) d)EFI_CERT_SHAXXX 2.Authenticated UEFI Variable 3.EFI PE/COFF Image(SHA256) <p>Key Source: Factory,External,Mixed</p> <hr/> <p>←: Select Screen ↑↓: Select Item Enter: Select +/-: Change Opt. F1: General Help F2: Previous Values F3: Optimized Defaults F4: Save & Reset ESC: Exit</p>
Secure Boot variable	Size	Ke																																																
> Platform Key(PK)	862																																																	
> Key Exchange Keys	1560																																																	
> Authorized Signatures	3143																																																	
> Forbidden Signatures	3724	77	Factory																																															
> Authorized TimeStamps	0	0	No Keys																																															
> OsRecovery Signatures	0	0	No Keys																																															

Version 2.20.1275. Copyright (C) 2020 American Megatrends, Inc.

Bios-Eintrag	Optionen
Vendor Keys	Keine
Key Exchange Keys	Key Exchange Keys, siehe Kasten

8.5.1.3.9 Authorized Signatures

Aptio Setup Utility - Copyright (C) 2020 American Megatrends, Inc.
Security

<p>Vendor Keys Modified</p> <p>Factory Key Provision [Disabled]</p> <p>> Restore Factory Keys</p> <p>> Reset To Setup Mode</p> <p>> Export Secure Boot variables</p> <p>> Enroll Efi Image</p> <p>Device Guard Ready</p> <p>> Remove 'UEFI CA' from DB</p> <p>> Restore DB defaults</p> <table style="width: 100%; border-collapse: collapse;"> <tr> <td style="width: 30%;">Secure Boot variable</td> <td style="width: 10%;">Size</td> <td style="width: 10%;">Ke</td> <td style="width: 50%;"></td> </tr> <tr> <td>> Platform Key(PK)</td> <td>862</td> <td></td> <td></td> </tr> <tr> <td>> Key Exchange Keys</td> <td>1560</td> <td></td> <td></td> </tr> <tr> <td>> Authorized Signatures</td> <td>3143</td> <td></td> <td></td> </tr> <tr> <td>> Forbidden Signatures</td> <td>3724</td> <td>77</td> <td>Factory</td> </tr> <tr> <td>> Authorized TimeStamps</td> <td>0</td> <td>0</td> <td>No Keys</td> </tr> <tr> <td>> OsRecovery Signatures</td> <td>0</td> <td>0</td> <td>No Keys</td> </tr> </table>	Secure Boot variable	Size	Ke		> Platform Key(PK)	862			> Key Exchange Keys	1560			> Authorized Signatures	3143			> Forbidden Signatures	3724	77	Factory	> Authorized TimeStamps	0	0	No Keys	> OsRecovery Signatures	0	0	No Keys	<p>Enroll Factory Defaults or load certificates from a file:</p> <p>1.Public Key Certificate:</p> <p>a)EFI_SIGNATURE_LIST</p> <p>b)EFI_CERT_X509 (DER)</p> <p>c)EFI_CERT_RSA2048 (bin)</p> <p>d)EFI_CERT_SHAXXX</p> <p>2.Authenticated UEFI Variable</p> <p>3.EFI PE/COFF Image(SHA256)</p> <p>Key Source:</p> <p>Factory,External,Mixed</p> <hr/> <p>←: Select Screen</p> <p>↑↓: Select Item</p> <p>Enter: Select</p> <p>+/-: Change Opt.</p> <p>F1: General Help</p> <p>F2: Previous Values</p> <p>F3: Optimized Defaults</p> <p>F4: Save & Reset</p> <p>ESC: Exit</p>
Secure Boot variable	Size	Ke																											
> Platform Key(PK)	862																												
> Key Exchange Keys	1560																												
> Authorized Signatures	3143																												
> Forbidden Signatures	3724	77	Factory																										
> Authorized TimeStamps	0	0	No Keys																										
> OsRecovery Signatures	0	0	No Keys																										

Version 2.20.1275. Copyright (C) 2020 American Megatrends, Inc.

Bios-Eintrag	Optionen
Vendor Keys	Keine
Authorized Signatures	Authorized Signatures, siehe Kasten

8.5.1.3.10 Forbidden Signatures

Aptio Setup Utility - Copyright (C) 2020 American Megatrends, Inc.
Security

<p>Vendor Keys Modified</p> <p>Factory Key Provision [Disabled]</p> <p>> Restore Factory Keys</p> <p>> Reset To Setup Mode</p> <p>> Export Secure Boot variables</p> <p>> Enroll Efi Image</p> <p>Device Guard Ready</p> <p>> Remove 'UEFI CA' from DB</p> <p>> Restore DB defaults</p> <table style="width: 100%; border-collapse: collapse;"> <tr> <td style="width: 30%;">Secure Boot variable</td> <td style="width: 10%;">Size</td> <td style="width: 10%;">Ke</td> <td style="width: 50%;"></td> </tr> <tr> <td>> Platform Key(PK)</td> <td>862</td> <td></td> <td></td> </tr> <tr> <td>> Key Exchange Keys</td> <td>1560</td> <td></td> <td></td> </tr> <tr> <td>> Authorized Signatures</td> <td>3143</td> <td></td> <td></td> </tr> <tr> <td>> Forbidden Signatures</td> <td>3724</td> <td>77</td> <td>Factory</td> </tr> <tr> <td>> Authorized TimeStamps</td> <td>0</td> <td>0</td> <td>No Keys</td> </tr> <tr> <td>> OsRecovery Signatures</td> <td>0</td> <td>0</td> <td>No Keys</td> </tr> </table>	Secure Boot variable	Size	Ke		> Platform Key(PK)	862			> Key Exchange Keys	1560			> Authorized Signatures	3143			> Forbidden Signatures	3724	77	Factory	> Authorized TimeStamps	0	0	No Keys	> OsRecovery Signatures	0	0	No Keys	<div style="border: 1px solid black; padding: 5px; margin-bottom: 10px;"> <p style="text-align: center;">Forbidden Signatures</p> <hr/> <p>Details</p> <p>Export</p> <p>Update</p> <p>Append</p> <p>Delete</p> </div> <p>Enroll Factory Defaults or load certificates from a file:</p> <ol style="list-style-type: none"> 1.Public Key Certificate: <ol style="list-style-type: none"> a)EFI_SIGNATURE_LIST b)EFI_CERT_X509 (DER) c)EFI_CERT_RSA2048 (bin) d)EFI_CERT_SHAXXX 2.Authenticated UEFI Variable 3.EFI PE/COFF Image(SHA256) <p>Key Source: Factory,External,Mixed</p> <hr/> <p>←: Select Screen</p> <p>↑↓: Select Item</p> <p>Enter: Select</p> <p>+/-: Change Opt.</p> <p>F1: General Help</p> <p>F2: Previous Values</p> <p>F3: Optimized Defaults</p> <p>F4: Save & Reset</p> <p>ESC: Exit</p>
Secure Boot variable	Size	Ke																											
> Platform Key(PK)	862																												
> Key Exchange Keys	1560																												
> Authorized Signatures	3143																												
> Forbidden Signatures	3724	77	Factory																										
> Authorized TimeStamps	0	0	No Keys																										
> OsRecovery Signatures	0	0	No Keys																										

Version 2.20.1275. Copyright (C) 2020 American Megatrends, Inc.

Bios-Eintrag	Optionen
Vendor Keys	Keine
Forbidden Signatures	Forbidden Signatures, siehe Kasten

8.5.1.3.11 Authorized TimeStamps

Aptio Setup Utility - Copyright (C) 2020 American Megatrends, Inc.
Security

<p>Vendor Keys</p> <p>Factory Key Provision [Disabled]</p> <p>> Restore Factory Keys</p> <p>> Reset To Setup Mode</p> <p>> Export Secure Boot variables</p> <p>> Enroll Efi Image</p> <p>Device Guard Ready</p> <p>> Remove 'UEFI CA' from DB</p> <p>> Restore DB defaults</p>	<p style="text-align: center;">Authorized TimeStamps</p> <table border="1" style="width: 100%; border-collapse: collapse;"> <tr> <td style="text-align: center;">Update</td> </tr> <tr> <td style="text-align: center;">Append</td> </tr> </table> <table border="1" style="width: 100%; border-collapse: collapse;"> <thead> <tr> <th style="text-align: left;">Secure Boot variable</th> <th style="text-align: left;">Size</th> <th style="text-align: left;">Ke</th> <th style="text-align: left;">Ke</th> </tr> </thead> <tbody> <tr> <td>> Platform Key(PK)</td> <td>862</td> <td></td> <td></td> </tr> <tr> <td>> Key Exchange Keys</td> <td>1560</td> <td>1</td> <td>Factory</td> </tr> <tr> <td>> Authorized Signatures</td> <td>3143</td> <td>2</td> <td>Factory</td> </tr> <tr> <td>> Forbidden Signatures</td> <td>3724</td> <td>77</td> <td>Factory</td> </tr> <tr> <td>> Authorized TimeStamps</td> <td>0</td> <td>0</td> <td>No Keys</td> </tr> <tr> <td>> OsRecovery Signatures</td> <td>0</td> <td>0</td> <td>No Keys</td> </tr> </tbody> </table>	Update	Append	Secure Boot variable	Size	Ke	Ke	> Platform Key(PK)	862			> Key Exchange Keys	1560	1	Factory	> Authorized Signatures	3143	2	Factory	> Forbidden Signatures	3724	77	Factory	> Authorized TimeStamps	0	0	No Keys	> OsRecovery Signatures	0	0	No Keys	<p>Enroll Factory Defaults or load certificates from a file:</p> <p>1.Public Key Certificate:</p> <p>a)EFI_SIGNATURE_LIST</p> <p>b)EFI_CERT_X509 (DER)</p> <p>c)EFI_CERT_RSA2048 (bin)</p> <p>d)EFI_CERT_SHAXXX</p> <p>2.Authenticated UEFI Variable</p> <p>3.EFI PE/COFF Image(SHA256)</p> <p>Key Source:</p> <p>Factory,External,Mixed</p> <hr/> <p>><: Select Screen</p> <p>^v: Select Item</p> <p>Enter: Select</p> <p>+/-: Change Opt.</p> <p>F1: General Help</p> <p>F2: Previous Values</p> <p>F3: Optimized Defaults</p> <p>F4: Save & Reset</p> <p>ESC: Exit</p>
Update																																
Append																																
Secure Boot variable	Size	Ke	Ke																													
> Platform Key(PK)	862																															
> Key Exchange Keys	1560	1	Factory																													
> Authorized Signatures	3143	2	Factory																													
> Forbidden Signatures	3724	77	Factory																													
> Authorized TimeStamps	0	0	No Keys																													
> OsRecovery Signatures	0	0	No Keys																													

Version 2.20.1275. Copyright (C) 2020 American Megatrends, Inc.

Bios-Eintrag	Optionen
Vendor Keys	Keine
Authorized TimeStamps	Authorized TimeStamps, siehe Kasten

8.5.1.3.12 OsRecovery Signatures

Aptio Setup Utility - Copyright (C) 2020 American Megatrends, Inc.
Security

<p>Vendor Keys Modified</p> <p>Factory Key Provision [Disabled]</p> <p>> Restore Factory Keys</p> <p>> Reset To Setup Mode</p> <p>> Export Secure Boot variables</p> <p>> Enroll Efi Image</p> <p>Device Guard Ready</p> <p>> Remove 'UEFI CA' from DB</p> <p>> Restore DB defaults</p>	<div style="border: 1px solid black; padding: 5px; text-align: center;"> OsRecovery Signatures </div> <div style="border: 1px solid black; padding: 5px; text-align: center;"> Update Append </div>	<p>Enroll Factory Defaults or load certificates from a file:</p> <p>1.Public Key Certificate:</p> <p>a)EFI_SIGNATURE_LIST</p> <p>b)EFI_CERT_X509 (DER)</p> <p>c)EFI_CERT_RSA2048 (bin)</p> <p>d)EFI_CERT_SHAXXX</p> <p>2.Authenticated UEFI Variable</p> <p>3.EFI PE/COFF Image(SHA256)</p> <p>Key Source:</p> <p>Factory,External,Mixed</p> <hr/> <p>←: Select Screen</p> <p>↑↓: Select Item</p> <p>Enter: Select</p> <p>+/-: Change Opt.</p> <p>F1: General Help</p> <p>F2: Previous Values</p> <p>F3: Optimized Defaults</p> <p>F4: Save & Reset</p> <p>ESC: Exit</p>																																			
<table border="1" style="width: 100%; border-collapse: collapse;"> <thead> <tr> <th style="width: 25%;">Secure Boot variable</th> <th style="width: 10%;">Size</th> <th style="width: 10%;">Ke</th> <th style="width: 10%;">Ke</th> <th style="width: 45%;"></th> </tr> </thead> <tbody> <tr> <td>> Platform Key(PK)</td> <td>862</td> <td></td> <td></td> <td></td> </tr> <tr> <td>> Key Exchange Keys</td> <td>1560</td> <td>1</td> <td></td> <td>Factory</td> </tr> <tr> <td>> Authorized Signatures</td> <td>3143</td> <td>2</td> <td></td> <td>Factory</td> </tr> <tr> <td>> Forbidden Signatures</td> <td>3724</td> <td>77</td> <td></td> <td>Factory</td> </tr> <tr> <td>> Authorized TimeStamps</td> <td>0</td> <td>0</td> <td></td> <td>No Keys</td> </tr> <tr> <td>> OsRecovery Signatures</td> <td>0</td> <td>0</td> <td></td> <td>No Keys</td> </tr> </tbody> </table>			Secure Boot variable	Size	Ke	Ke		> Platform Key(PK)	862				> Key Exchange Keys	1560	1		Factory	> Authorized Signatures	3143	2		Factory	> Forbidden Signatures	3724	77		Factory	> Authorized TimeStamps	0	0		No Keys	> OsRecovery Signatures	0	0		No Keys
Secure Boot variable	Size	Ke	Ke																																		
> Platform Key(PK)	862																																				
> Key Exchange Keys	1560	1		Factory																																	
> Authorized Signatures	3143	2		Factory																																	
> Forbidden Signatures	3724	77		Factory																																	
> Authorized TimeStamps	0	0		No Keys																																	
> OsRecovery Signatures	0	0		No Keys																																	

Version 2.20.1275. Copyright (C) 2020 American Megatrends, Inc.

Bios-Eintrag	Optionen
Vendor Keys	Keine
OsRecovery Signatures	OsRecovery Signatures, siehe Kasten

8.6 Boot

```

Aptio Setup Utility - Copyright (C) 2020 American Megatrends, Inc.
Main  Advanced  Chipset  Security  Boot  Save & Exit

Boot Configuration
Setup Prompt Timeout          1
Bootup NumLock State         [Off]
Quiet Boot                    [Enabled]
Fast Boot                     [Disable Link]

StartUpDelay for UEFI shell   5
Boot mode select              [UEFI]

FIXED BOOT ORDER Priorities
Boot Option #1                [UEFI Service Stick]
Boot Option #2                [UEFI CFast]
Boot Option #3                [UEFI SSD]
Boot Option #4                [UEFI HDD]
Boot Option #5                [UEFI CD/DVD]
Boot Option #6                [UEFI USB Stick]
Boot Option #7                [UEFI USB Floppy]
Boot Option #8                [UEFI USB Hard Disk]
Boot Option #9                [UEFI USB CD/DVD]
Boot Option #10               [UEFI Network]
Boot Option #11               [UEFI USB Lan]

> Advanced Fixed Boot Order Parameters

Number of seconds to wait for
setup activation key.
65535 (0xFFFF) means indefinite
waiting.

←: Select Screen
↑↓: Select Item
Enter: Select
+/-: Change Opt.
F1: General Help
F2: Previous Values
F3: Optimized Defaults
F4: Save & Reset
ESC: Exit
    
```

Version 2.20.1275. Copyright (C) 2020 American Megatrends, Inc.

Bios-Eintrag	Optionen
Boot Configuration	
Setup Prompt Timeout	Keine
Bootup NumLok State	On/Off
Quiet Boot	Enabled/Disabled
Fast Boot	Disable Link/Enabled
StartUpDelay for UEFI shell	Keine
Boot mode select	Keine
Fixed Boot Order Priorities	
Boot Option #1-11	Hier setzen Sie die Reihenfolge der zu verwendenden Bootmedien.
Advanced Fixed Boot Order Parameters	Untermenü siehe: Fixed Boot Order Parameters [▶ 102]

8.6.1 Fixed Boot Order Parameters

Aptio Setup Utility - Copyright (C) 2020 American Megatrends, Inc.
Boot

Min. CFAST capacity (GB)	0	Lower capacity limit for boot group CFAST in GB
Max. CFAST capacity (GB)	119	
Min. SSD capacity (GB)	119	
Max. SSD capacity (GB)	481	
Min. HDD capacity (GB)	481	
Max. HDD capacity (GB)	8000000	
Max. USB Stick capacity (GB)	64	
UEFI BDS Boot Filter	[Enabled]	
Re-enable UEFI Disks	[Enabled]	
BootDeviceDef Version 3(11/22/2018)		

Version 2.20.1275. Copyright (C) 2020 American Megatrends, Inc.

Bios-Eintrag	Optionen
Min. CFAST capacity (GB)	Keine
Max. CFAST capacity (GB)	Keine
Min. SSD capacity (GB)	Keine
Max. SSD capacity (GB)	Keine
Min. HDD capacity (GB)	Keine
Max. HDD capacity (GB)	Keine
Max. USB Stick capacity (GB)	Keine
UEFI BDS Boot Filter	Enabled/Disabled
Re-enable UEFI Disks	Enabled/Disabled
BootDeviceDef Version 3(11/22/2018)	

8.7 Save & Exit

Aptio Setup Utility - Copyright (C) 2020 American Megatrends, Inc.

Main Advanced Chipset Security Boot **Save & Exit**

Save Changes and Reset Discard Changes and Reset Restore Defaults Boot Override Launch EFI Shell from filesystem device	Reset the system after saving the changes. ><: Select Screen ^v: Select Item Enter: Select +/-: Change Opt. F1: General Help F2: Previous Values F3: Optimized Defaults F4: Save & Reset ESC: Exit
---	---

Version 2.20.1275. Copyright (C) 2020 American Megatrends, Inc.

Bios-Eintrag	Optionen
Save Changes and Reset	Eingabetaste drücken
Discard Changes and Reset	Eingabetaste drücken
Restore Optimized Defaults	Eingabetaste drücken
Boot Override	
Launch EFI Shell from filesystem device	Eingabetaste drücken

8.8 BIOS-Update

Wenn ein Update des BIOS vorgenommen werden soll, dann wird hierzu das Programm „DecdFlsh“ sowie ein bootfähiges Medium mit der aktuellsten BIOS-Version benutzt. Dabei ist es wichtig, dass das Programm aus einer DOS-Umgebung ohne einen virtuellen Speichermanager wie zum Beispiel „EMM386.EXE“ gestartet wird. Sollte ein solcher Speichermanager geladen sein, wird das Programm mit einer Fehlermeldung abbrechen oder einen Absturz verursachen.

DecdFlsh ist ein Programm zum automatischen Update des BIOS auf allen Boards mit AMI-BIOS. Alle Dateien aus dem zip-Verzeichnis müssen in ein Verzeichnis entpackt werden. Von dort wird

```
DecdFlsh Bios-Dateiname
```

aufgerufen. Der Name der BIOS-Datei und deren Länge werden überprüft. Das BIOS wird nun programmiert.

Während des Flash-Vorgangs darf das System auf keinen Fall unterbrochen werden, da sonst das Update abbricht und anschließend das BIOS auf dem Board zerstört ist. Der Flash-Vorgang dauert etwa 75 Sekunden. Das erforderliche Firmware-Update erfolgt automatisch.

HINWEIS

Beschädigung durch falsche Update-Durchführung

Folgen Wenn das BIOS-Update fehlerhaft durchgeführt wird, kann das Board dadurch unbenutzbar werden. Deshalb sollte ein BIOS-Update nur gemacht werden, wenn die Korrekturen/Ergänzungen, die die neue BIOS-Version mitbringt, auch wirklich benötigt werden.

Vor einem geplanten BIOS-Update muss unbedingt sichergestellt werden, dass die BIOS-Datei, die neu eingespielt werden soll, wirklich für genau dieses Board und für genau diese Boardversion herausgegeben wurde. Wenn eine ungeeignete Datei verwendet wird, dann führt dies unweigerlich dazu, dass das Board anschließend nicht mehr startet.

9 Mechanische Zeichnung

HINWEIS

Maßangaben

Alle Maßangaben in mil (1 mil = 0,0254 mm). Angaben in eckigen Klammern sind in mm.

9.1 Leiterplatte: Outlines



Abb. 18: CB3067-MZ

9.2 Leiterplatte: Bohrungen

Mounting Holes H1 - H5: Inner diameter 126, Outer diameter 252

dimension = mil

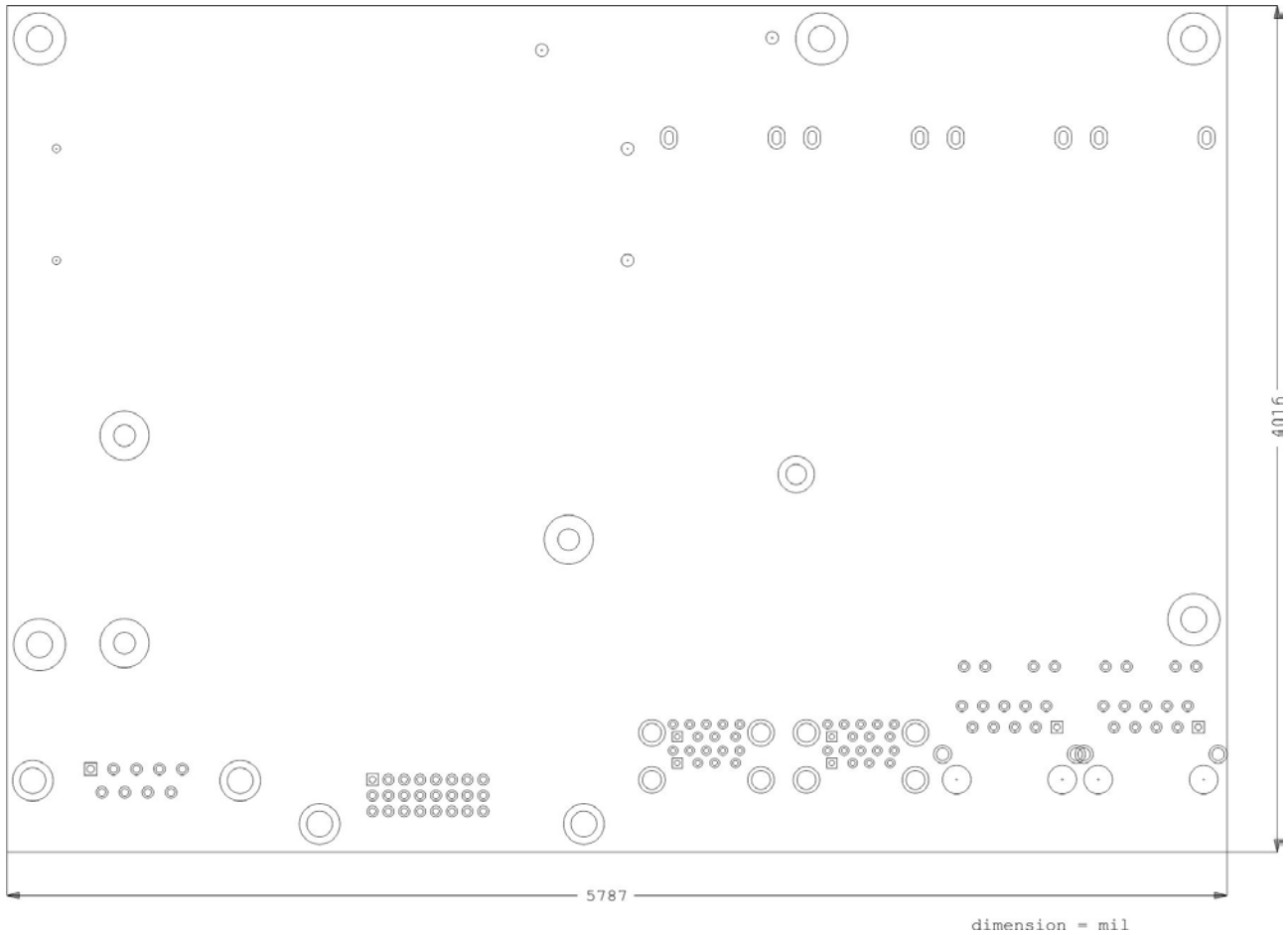

Abb. 19: CB3067-MZ-MH

9.3 Leiterplatte: Pin-1-Abstände

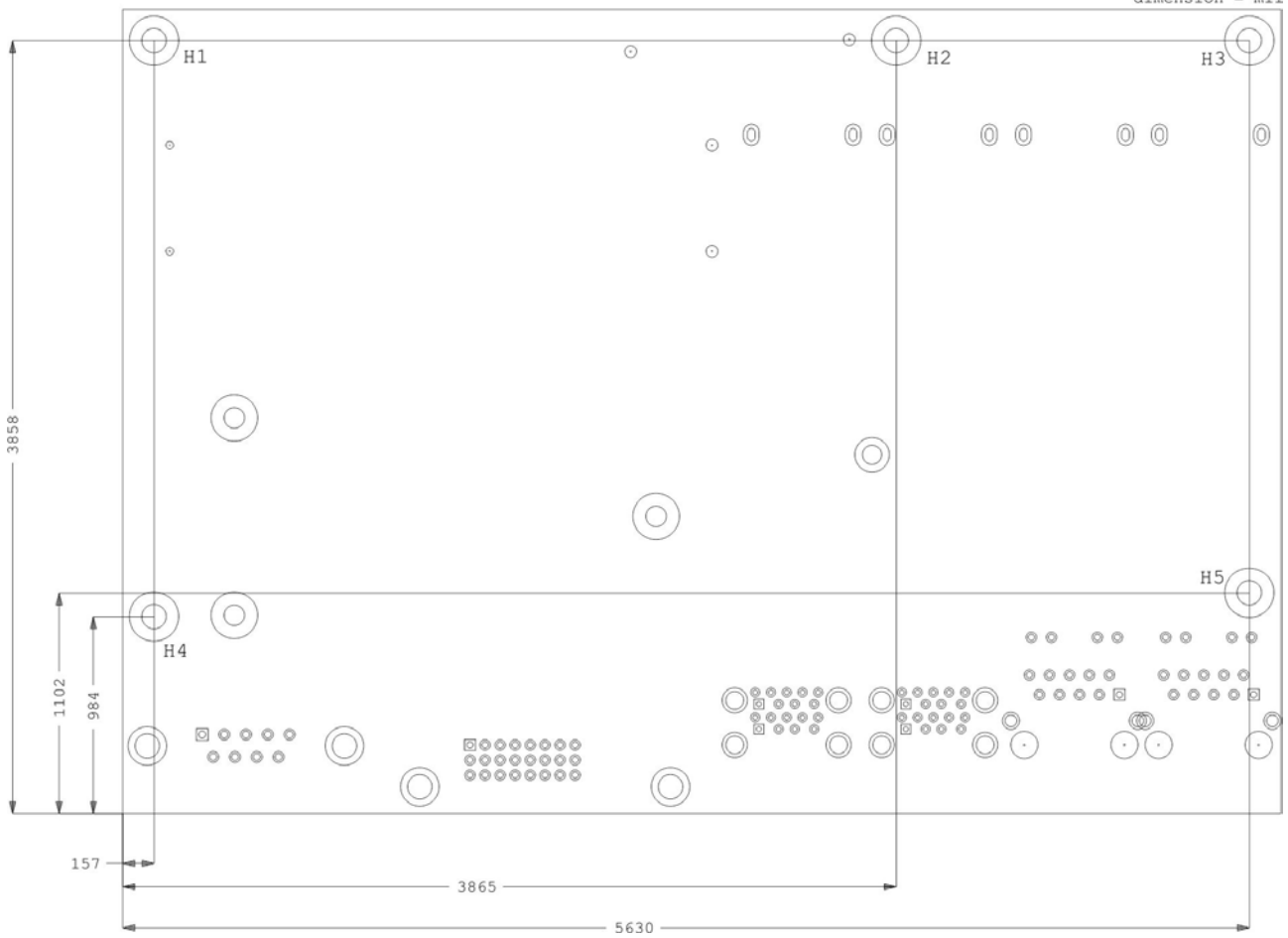

Abb. 20: CB3067-MZ-Pin1

9.4 Leiterplatte: Heat Sink



Abb. 21: CB3067-Cooling Top

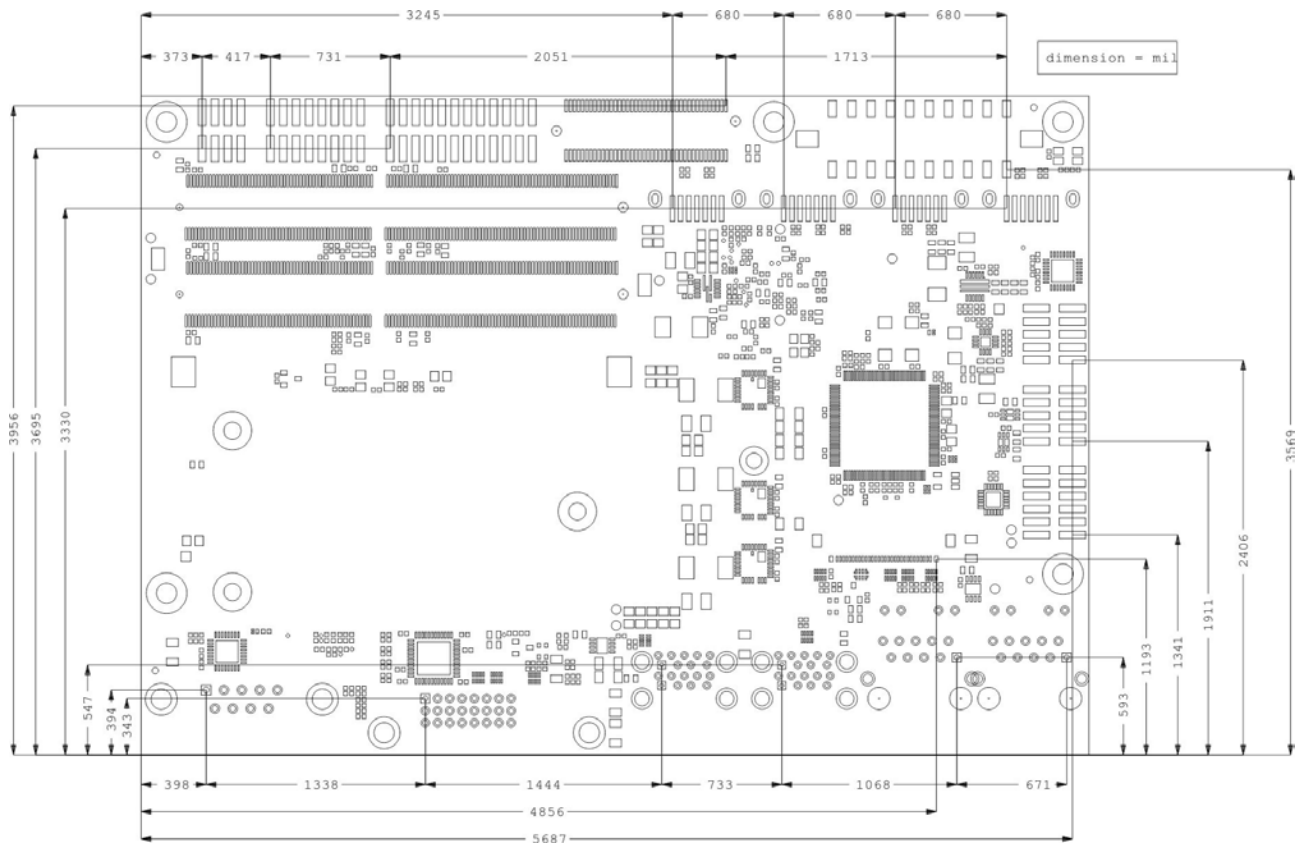

Abb. 22: CB3067-Cooling Bottom

10 Technische Daten

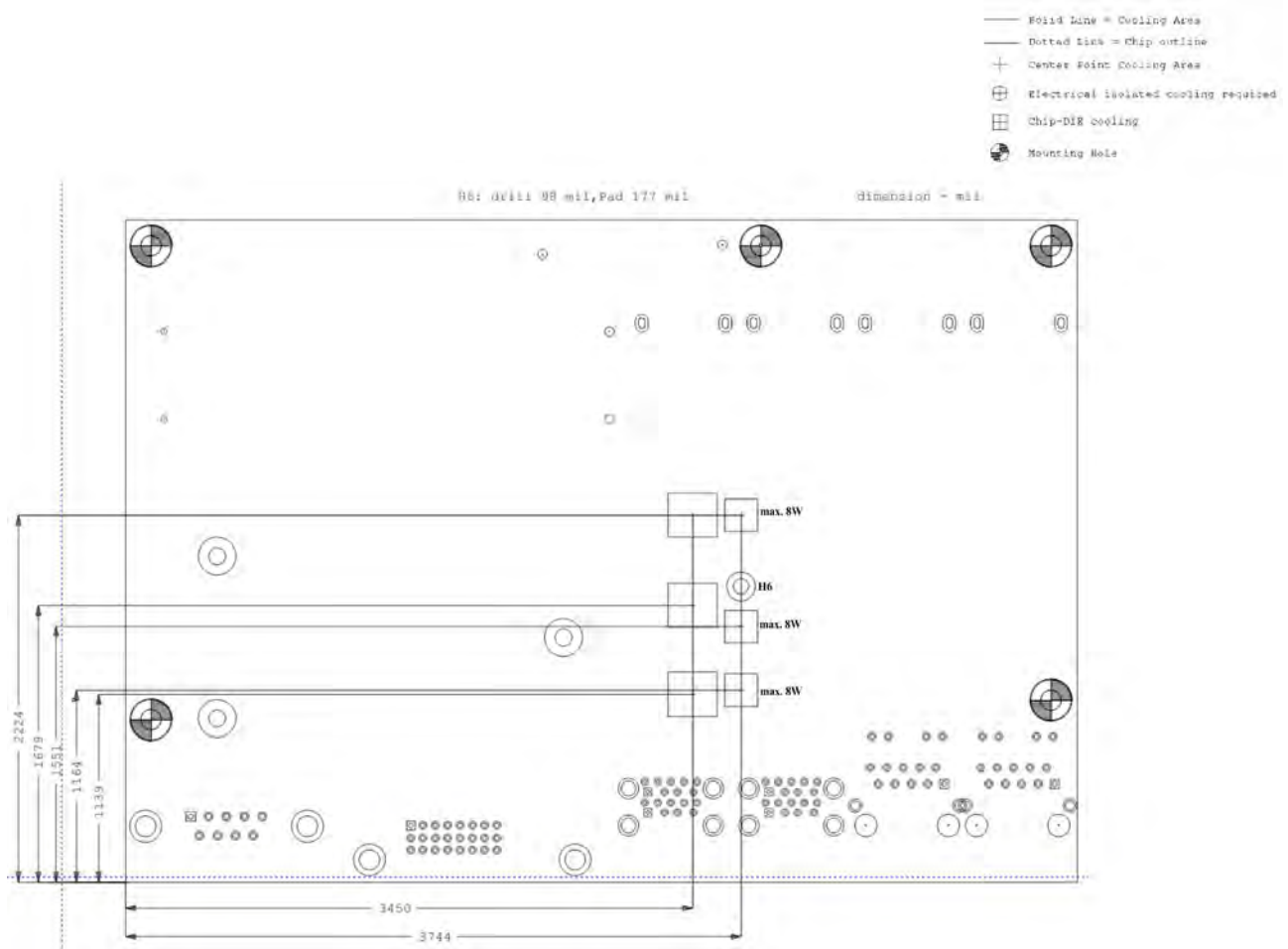
10.1 Elektrische Daten

Spannungsversorgung	
Board	3,3 Volt, 5 Volt und 12 Volt ($\pm 5\%$)
RTC	≥ 3 Volt
Stromverbrauch	
RTC	$\leq 10 \mu\text{A}$

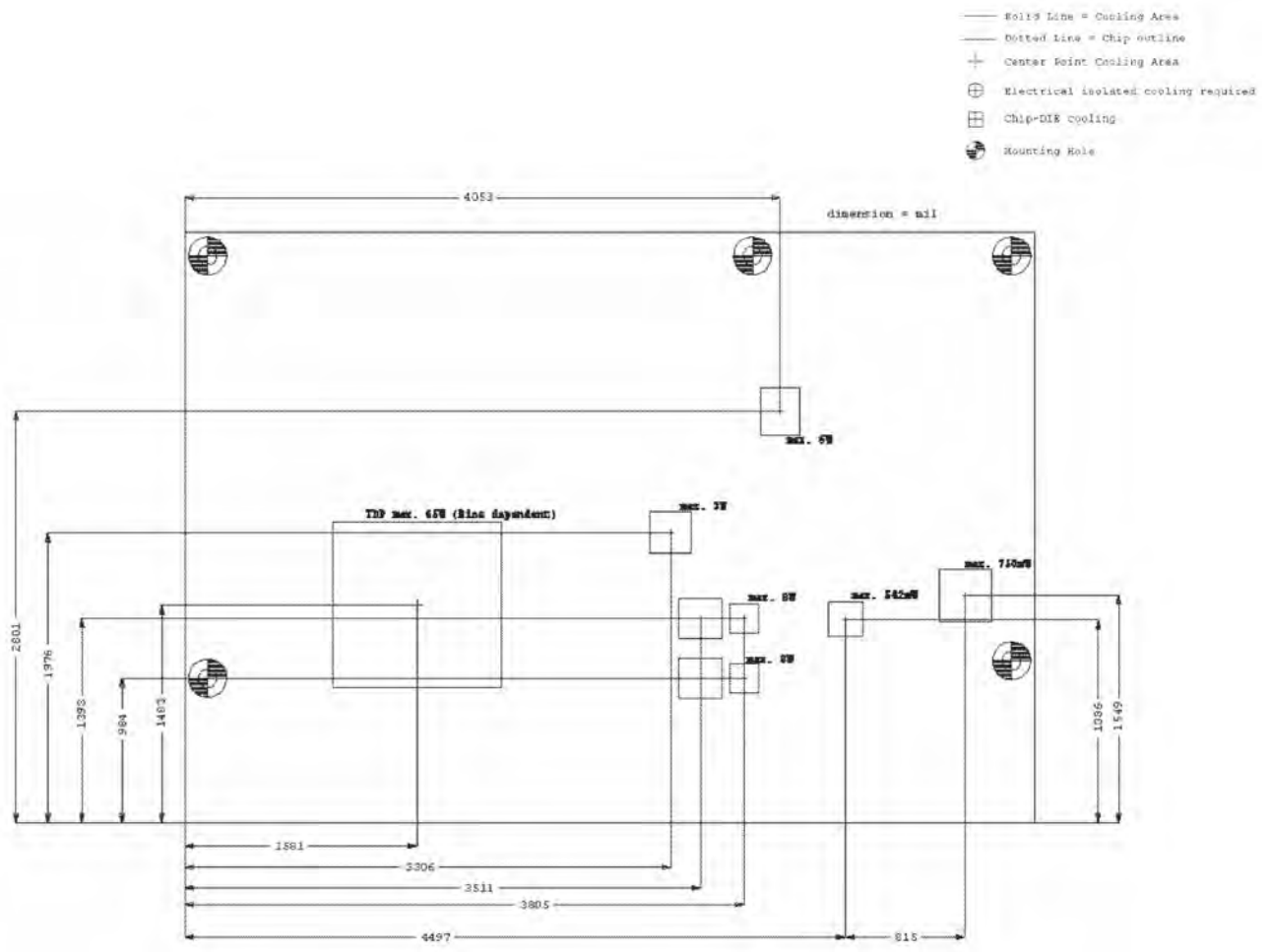
10.2 Umgebungsbedingungen

Temperaturbereich	
Operating	0 °C bis +60 °C (erweiterter Temperaturbereich auf Anfrage)
Lagerung	-25 °C bis +85 °C
Versand	-25 °C bis +85 °C, für verpackte Boards

Temperaturänderungen	
Operating	0,5 °C pro Minute, 7,5 °C in 30 Minuten
Lagerung	1,0 °C pro Minute
Versand	1,0 °C pro Minute, für verpackte Boards

Relative Luftfeuchte	
Operating	5% bis 85% (nicht kondensierend)
Lagerung	5% bis 95% (nicht kondensierend)
Versand	5% bis 100% (nicht kondensierend), für verpackte Boards

Stoß	
Operating	150 m/s ² , 6 ms
Lagerung	400 m/s ² , 6 ms
Versand	400 m/s ² , 6 ms, für verpackte Boards

Vibration	
Operating	10 bis 58 Hz, 0,075 mm Amplitude
Lagerung	5 bis 9 Hz, 3,5 mm Amplitude 9 bis 500 Hz, 10 m/s ²
Versand	5 bis 9 Hz, 3,5 mm Amplitude 9 bis 500 Hz, 10 m/s ² , für verpackte Boards

i Hinweis zu Stoß- und Vibrationsfestigkeit

Die Angaben zu Stoß- und Vibrationsfestigkeit beziehen sich auf das reine Motherboard ohne Kühlkörper, Speicherriegel, Verkabelungen usw.

10.3 Thermische Spezifikationen

Das Board ist spezifiziert für einen Umgebungstemperaturbereich von 0°C bis +60°C (erw. Temperaturbereich auf Anfrage). Zusätzlich müssen Sie darauf achten, dass die Temperatur des Prozessor-Dies 100°C nicht überschreitet. Hierfür müssen Sie ein geeignetes Kühlkonzept realisieren, das sich an der maximalen Leistungsaufnahme des Prozessors/Chipsatzes orientiert. Beachten Sie, dass eventuell vorhandene Controller im Kühlkonzept Berücksichtigung finden. Die Leistungsaufnahme dieser Bausteine liegt unter Umständen in der gleichen Größenordnung wie die Leistungsaufnahme des Prozessors.

Das Board ist durch Bohrungen für den Einsatz geeigneter Kühl-Lösungen vorbereitet. Wir haben eine Reihe von kompatiblen Kühl-Komponenten im Programm. Ihr Distributor berät Sie gerne bei der Auswahl geeigneter Lösungen.

HINWEIS

Überschreiten der maximalen Die-Temperatur verhindern!

Es liegt im Verantwortungsbereich des Endkunden, dass die Die-Temperatur des Prozessors 100°C nicht überschreitet! Eine dauerhafte Überhitzung kann das Board zerstören!

Für den Fall, dass die Temperatur 100°C überschreitet, müssen Sie die Umgebungstemperatur reduzieren. Unter Umständen müssen Sie für eine ausreichende Luftzirkulation Sorge tragen.

11 Support und Service

Beckhoff und seine weltweiten Partnerfirmen bieten einen umfassenden Support und Service, der eine schnelle und kompetente Unterstützung bei allen Fragen zu Beckhoff Produkten und Systemlösungen zur Verfügung stellt.

Downloadfinder

Unser [Downloadfinder](#) beinhaltet alle Dateien, die wir Ihnen zum Herunterladen anbieten. Sie finden dort Applikationsberichte, technische Dokumentationen, technische Zeichnungen, Konfigurationsdateien und vieles mehr.

Die Downloads sind in verschiedenen Formaten erhältlich.

Beckhoff Niederlassungen und Vertretungen

Wenden Sie sich bitte an Ihre Beckhoff Niederlassung oder Ihre Vertretung für den [lokalen Support und Service](#) zu Beckhoff Produkten!

Die Adressen der weltweiten Beckhoff Niederlassungen und Vertretungen entnehmen Sie bitte unserer Internetseite: www.beckhoff.com

Dort finden Sie auch weitere Dokumentationen zu Beckhoff Komponenten.

Beckhoff Support

Der Support bietet Ihnen einen umfangreichen technischen Support, der Sie nicht nur bei dem Einsatz einzelner Beckhoff Produkte, sondern auch bei weiteren umfassenden Dienstleistungen unterstützt:

- Support
- Planung, Programmierung und Inbetriebnahme komplexer Automatisierungssysteme
- umfangreiches Schulungsprogramm für Beckhoff Systemkomponenten

Hotline: +49 5246 963-157
E-Mail: support@beckhoff.com

Beckhoff Service

Das Beckhoff Service-Center unterstützt Sie rund um den After-Sales-Service:

- Vor-Ort-Service
- Reparaturservice
- Ersatzteilservice
- Hotline-Service

Hotline: +49 5246 963-460
E-Mail: service@beckhoff.com

Beckhoff Unternehmenszentrale

Beckhoff Automation GmbH & Co. KG

Hülshorstweg 20
33415 Verl
Deutschland

Telefon: +49 5246 963-0
E-Mail: info@beckhoff.com
Internet: www.beckhoff.com

12 Anhang I: Post-Codes

Während der Bootphase generiert das BIOS eine Reihe von Statusmeldungen (sog. „POST-Codes“), die mit Hilfe eines geeigneten Lesegerätes (POST-Code-Karte) ausgegeben werden können. Die Bedeutung der POST-Codes wird in dem Dokument „Aptio™ 5.x Status Codes“ von American Megatrends® erläutert, das auf der Webseite <http://www.ami.com> erhältlich ist. Zusätzlich werden die folgenden OEM-POST-Codes ausgegeben:

Code	Beschreibung
87h	BIOS-API gestartet
88h	PCA9535 gestartet
89h	PWRCTRL-Firmware gestartet

13 Anhang II: Ressourcen

13.1 Interrupt

Die verwendeten Ressourcen sind abhängig von der Setup-Einstellung. Die aufgeführten Interrupts und deren Benutzung sind durch die AT-Kompatibilität gegeben. Wenn Interrupts exklusiv auf der ISA-Seite zur Verfügung stehen müssen, sind diese durch das BIOS-Setup zu reservieren. Auf der PCI-Seite ist die Exklusivität nicht gegeben und auch nicht möglich.

13.2 PCI-Devices

Die hier aufgeführten PCI-Devices sind alle auf dem Board vorhandenen, inklusive der, die durch das BIOS erkannt und konfiguriert werden. Durch Setup-Einstellungen des BIOS kann es vorkommen, dass verschiedene PCI-Devices oder Funktionen von Devices nicht aktiviert sind. Wenn Devices deaktiviert werden, kann sich dadurch bei anderen Devices die Bus-Nummer ändern.

Bus	Dev.	Fkt.	Controller / Slot
00	00	00	Host Bridge ID 3E30
00	01	00	PCI-to- PCI Bridge ID1901
00	01	01	PCI-to- PCI Bridge ID1905
00	01	02	PCI-to- PCI Bridge ID1909
00	02	00	VGA Controller ID3E98
00	08	00	System Device ID1911
00	12	00	Data Acquisition/Signal Processing Controller ID A379
00	14	00	XHCI USB Controller ID A36D
00	14	02	RAM Controller ID A36F
00	16	00	Communication Device ID A360
00	16	03	Serial Device ID A363
00	17	00	RAID Controller ID 2822
00	1D	00	PCI-to-PCI Bridge ID A330
00	1D	04	PCI-to-PCI Bridge ID A334
00	1F	02	ISA Bridge ID A306
00	1F	03	HD Audio Device ID A348
00	1F	04	SMBus Controller ID A323
00	1F	05	Controller ID A324
00	1F	06	Ethernet Controller ID 15BB
01	00	00	Ethernet Controller (PCIE) ID 1533
02	00	00	Ethernet Controller (PCIE) ID 1533
03	00	00	Ethernet Controller (PCIE) ID 1533
05	00	00	Mass Storage Controller (PCIE) ID 5008

13.3 SMB-Devices

Die folgende Tabelle listet die reservierten SM-Bus-Device-Adressen in 8-Bit-Schreibweise auf.

HINWEIS

Diese Adressbereiche dürfen auch dann nicht von externen Geräten benutzt werden, wenn die in der Tabelle zugeordnete Komponente auf dem Motherboard gar nicht vorhanden ist.

Adresse	Funktion
34-35	API-Zugriff auf Netzteil
36-39	Reserviert
5C-5D	NCT7491
60-6F	Reserviert für DDR4
70-73	POST-Code Output
88-89	Vom BIOS definierte Slave-Adresse
A0-A7	Reserviert für DDR4
B0-B3	Power-Controller (Zugriff über BIOS-API)
B8-BB	Power-Controller (Zugriff über BIOS-API)

Beckhoff Automation GmbH & Co. KG
Hülshorstweg 20
33415 Verl
Deutschland
Telefon: +49 5246 9630
info@beckhoff.com
www.beckhoff.com