

**BECKHOFF** New Automation Technology

Manual | EN

**CX1010**

Embedded-PC



# Table of contents

<b>1 Foreword</b> .....	<b>5</b>
1.1 Notes on the documentation.....	5
1.2 Safety instructions .....	6
1.3 Notes on information security .....	7
1.4 Documentation Issue Status.....	7
<b>2 Product overview</b> .....	<b>8</b>
2.1 Appropriate Use.....	8
2.2 System overview .....	9
2.3 Basic modules .....	12
2.3.1 Technical data .....	12
2.3.2 Configurations.....	13
2.3.3 Connections .....	14
2.3.4 Battery compartment .....	16
2.3.5 Compact Flash slot .....	16
2.3.6 Compact Flash card.....	18
2.3.7 Adapter RAM Hardware address overview.....	18
2.3.8 PC/104 Bus.....	19
2.4 System interfaces .....	21
2.4.1 Technical Data.....	21
2.4.2 CX1010-N010 connections.....	23
2.4.3 CX1020-N020 connections.....	24
2.4.4 CX1010-N030/40 connections.....	25
2.4.5 CX1020-N031/41 connections.....	26
2.4.6 CX1020-N060 connections.....	29
2.5 Netzteile.....	30
2.5.1 CX1100-000x   Power supply units and I/O interfaces .....	30
2.5.2 Technical data CX1100-0001 .....	31
2.5.3 Technical data CX1100-0002 .....	32
2.5.4 Technical data CX1100-0012 .....	33
2.5.5 Technical data CX1100-0003 .....	34
2.5.6 Technical data CX1100-0013 .....	35
2.5.7 Technical data CX1100-0004 .....	36
2.5.8 Technical data CX1100-0014 .....	37
2.5.9 CX1100-0001 connections .....	38
2.5.10 CX1100-00x2 connections.....	39
2.5.11 CX1100-00x3 connections.....	39
2.5.12 CX1100-00x4 connections.....	40
2.5.13 LC Display .....	41
<b>3 Transport</b> .....	<b>42</b>
3.1 Unpacking, installation and transport .....	42
<b>4 Assembly and connecting</b> .....	<b>43</b>
4.1 Mechanical assembly .....	43
4.1.1 Dimensions .....	43

4.1.2	Mechanical assembly of the basic module .....	46
4.1.3	Mechanical installation of the fieldbus connection .....	48
4.2	Commissioning .....	49
4.2.1	Switching the PC on and off .....	49
4.3	Note on using the setup .....	49
4.3.1	Standard CMOS Features .....	50
4.3.2	Advanced BIOS Features .....	55
4.3.3	Advanced Chiset Features .....	57
4.3.4	Integrated Peripherals .....	58
4.3.5	Power Management Setup .....	61
4.3.6	PnP/PCI Configurations .....	63
4.3.7	PC Health Status .....	66
<b>5</b>	<b>Error handling and diagnostics .....</b>	<b>68</b>
5.1	CPU basic module .....	68
5.1.1	LEDs Basic CPU-Module .....	68
5.2	Power supply units .....	68
5.2.1	CX1100-0001 power supply LEDs .....	68
5.2.2	CX1100-0002 power supply LEDs .....	68
5.2.3	CX1100-0012 power supply LEDs .....	72
5.2.4	CX1100-0003 power supply LEDs .....	75
5.2.5	CX1100-0013 power supply LEDs .....	79
5.2.6	CX1100-0004 power supply LEDs .....	85
5.2.7	CX1100-0014 power supply LEDs .....	86
5.3	Faults .....	86
<b>6</b>	<b>Removal and disposal .....</b>	<b>88</b>
6.1	Removal and disposal .....	88
<b>7</b>	<b>Appendix .....</b>	<b>90</b>
7.1	Accessories .....	90
7.2	Certifications .....	90
7.3	Support and Service .....	91

# 1 Foreword

## 1.1 Notes on the documentation

This description is only intended for the use of trained specialists in control and automation engineering who are familiar with applicable national standards.

It is essential that the documentation and the following notes and explanations are followed when installing and commissioning the components.

It is the duty of the technical personnel to use the documentation published at the respective time of each installation and commissioning.

The responsible staff must ensure that the application or use of the products described satisfy all the requirements for safety, including all the relevant laws, regulations, guidelines and standards.

### Disclaimer

The documentation has been prepared with care. The products described are, however, constantly under development.

We reserve the right to revise and change the documentation at any time and without prior announcement. No claims for the modification of products that have already been supplied may be made on the basis of the data, diagrams and descriptions in this documentation.

### Trademarks

Beckhoff®, TwinCAT®, TwinCAT/BSD®, TC/BSD®, EtherCAT®, EtherCAT G®, EtherCAT G10®, EtherCAT P®, Safety over EtherCAT®, TwinSAFE®, XFC®, XTS® and XPlanar® are registered trademarks of and licensed by Beckhoff Automation GmbH.

Other designations used in this publication may be trademarks whose use by third parties for their own purposes could violate the rights of the owners.

### Patent Pending

The EtherCAT Technology is covered, including but not limited to the following patent applications and patents:

EP1590927, EP1789857, EP1456722, EP2137893, DE102015105702  
with corresponding applications or registrations in various other countries.



EtherCAT® is a registered trademark and patented technology, licensed by Beckhoff Automation GmbH, Germany

### Copyright

© Beckhoff Automation GmbH & Co. KG, Germany.

The reproduction, distribution and utilization of this document as well as the communication of its contents to others without express authorization are prohibited.

Offenders will be held liable for the payment of damages. All rights reserved in the event of the grant of a patent, utility model or design.

## 1.2 Safety instructions

### Safety regulations

Please note the following safety instructions and explanations!  
Product-specific safety instructions can be found on following pages or in the areas mounting, wiring, commissioning etc.

### Exclusion of liability

All the components are supplied in particular hardware and software configurations appropriate for the application. Modifications to hardware or software configurations other than those described in the documentation are not permitted, and nullify the liability of Beckhoff Automation GmbH & Co. KG.

### Personnel qualification

This description is only intended for trained specialists in control, automation and drive engineering who are familiar with the applicable national standards.

### Description of symbols

In this documentation the following symbols are used with an accompanying safety instruction or note. The safety instructions must be read carefully and followed without fail!

#### **DANGER**

##### **Serious risk of injury!**

Failure to follow the safety instructions associated with this symbol directly endangers the life and health of persons.

#### **WARNING**

##### **Risk of injury!**

Failure to follow the safety instructions associated with this symbol endangers the life and health of persons.

#### **CAUTION**

##### **Personal injuries!**

Failure to follow the safety instructions associated with this symbol can lead to injuries to persons.

#### **NOTE**

##### **Damage to the environment or devices**

Failure to follow the instructions associated with this symbol can lead to damage to the environment or equipment.



##### **Tip or pointer**

This symbol indicates information that contributes to better understanding.

## 1.3 Notes on information security

The products of Beckhoff Automation GmbH & Co. KG (Beckhoff), insofar as they can be accessed online, are equipped with security functions that support the secure operation of plants, systems, machines and networks. Despite the security functions, the creation, implementation and constant updating of a holistic security concept for the operation are necessary to protect the respective plant, system, machine and networks against cyber threats. The products sold by Beckhoff are only part of the overall security concept. The customer is responsible for preventing unauthorized access by third parties to its equipment, systems, machines and networks. The latter should be connected to the corporate network or the Internet only if appropriate protective measures have been set up.

In addition, the recommendations from Beckhoff regarding appropriate protective measures should be observed. Further information regarding information security and industrial security can be found in our <https://www.beckhoff.com/secguide>.

Beckhoff products and solutions undergo continuous further development. This also applies to security functions. In light of this continuous further development, Beckhoff expressly recommends that the products are kept up to date at all times and that updates are installed for the products once they have been made available. Using outdated or unsupported product versions can increase the risk of cyber threats.

To stay informed about information security for Beckhoff products, subscribe to the RSS feed at <https://www.beckhoff.com/secinfo>.

## 1.4 Documentation Issue Status

Version	Changes
1.6	changes to PC104 Bus added
1.5	annotations to battery recycling added
1.4	annotations to network ports changed
1.3	BIOS entries added
1.2	system interfaces CX1200-xxxx removed
1.1	system interfaces CX1010-N070 and CX1010-N080 renamed
1.0	version at start of series production
0.0.1	preliminarily version

## 2 Product overview

### 2.1 Appropriate Use

The CX1010 device series is a modular control system designed for top-hat rail installation. The system is scalable, so that the required modules can be assembled and installed in the control cabinet or terminal box as required.

#### Only switch the PC off after closing the software

Before the Embedded PC is switched off, the software currently running on it should be stopped properly in order to avoid data loss on the hard disk. Please read the section on “Switching off [► 49]”.

Switch off all system components and uncouple the Industrial PC from the system if the PC is not used for control purposes, e.g. during a function test. Disconnect the device by pulling the first terminal after the power supply unit (CX1100-002 and CX1100-002) (optional) and the fieldbus connectors. System components that have been switched off must be secured against being switched on again.

The power supply unit of the Embedded PC requires a 24 V DC supply.

#### DANGER

Do not exchange any parts when under power!

When components are being fitted or removed, the supply voltage must be switched off.

#### Software knowledge

#### NOTE

Mandatory software knowledge!

Every user must be familiar with any of the functions of the software installed on the PC that he can reach.



## 2.2 System overview

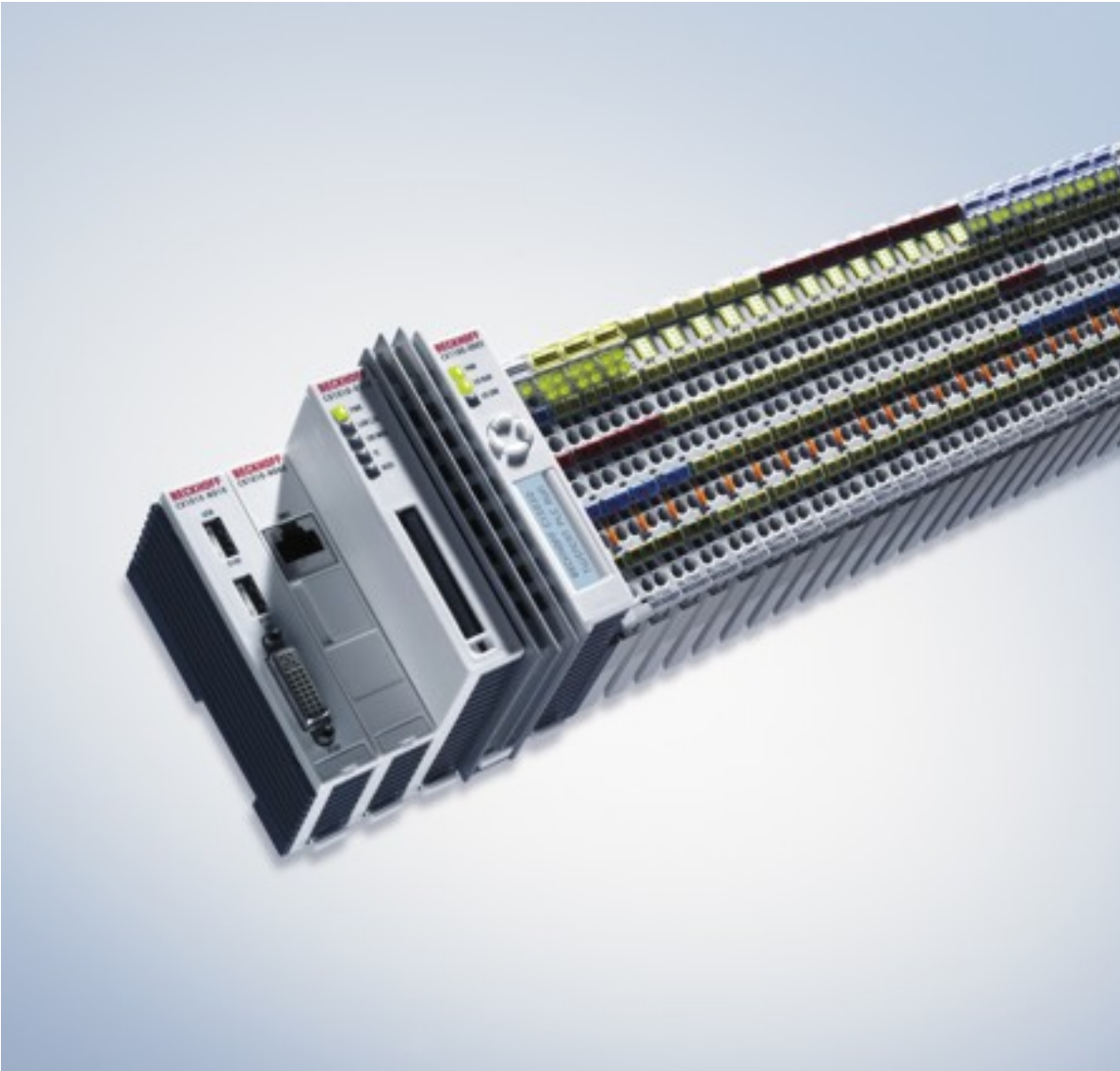

Fig. 1: CX1010\_foto

### The system

With the CX series of Embedded PCs Beckhoff has combined PC technology and modular I/O level to form a top-hat rail unit in the control cabinet. The CX1020 extends the CX product family by a version with higher CPU performance. The CX1020 enables direct connection of Bus Terminals and EtherCAT terminals.

While the CX1000 features an 266 MHz AMD Geode processor, the CX1010 is equipped with a 500 MHz AMD® Geode LX 800Intel(r) CPU. It is an energy-saving device that operates with ultra-low core voltage and features low thermal power dissipation of only 8 W TDP (thermal design power). As a result, no fan is required despite the compact design of the CX1010 Embedded PC. Since Compact Flash is used as boot and memory medium, no rotating media are required in the controller. This is an important aspect for increasing the MTBF (Mean Time Between Failures) of the overall system.

The case and assembly concept of the CX1010 is similar to that of its smaller brother, the CX1000: It also consists of several components that can be assembled by the user. The simplest configuration consists of a CPU module and a multi-functional power supply unit. The PC104 bus is used for the connection between these and all other CX components, although in the CX1020 this was extended with EtherCAT signals. The basic CPU module is equipped with one RJ-45 socket.

Like the CX1000, the CX1020 can be expanded with optional system interfaces. A DVI-I (=DVI-D + VGA) output, two USB-2.0 interfaces, up to four RS232 interfaces and audio are available. The four RS232 interfaces feature opto-decoupling and can optionally be implemented as RS422/RS.

The same reusability also applies to the multi-functional power supplied units (CX1100-000x) of the CX1020: one without I/O terminal connection, one with K-Bus connection, one with K-Bus and IP-Link connection for IP-67-protected Fieldbus Box modules, and a power supply unit with direct connection facility for Beckhoff EtherCAT Terminals.

### **EtherCAT as a fast I/O system**

The CX1010 Embedded PC was developed for optimum interaction with EtherCAT. The Ethernet interface of the CPU module is not primarily intended for EtherCAT operation. The EtherCAT connection is established via the EK1110 (EtherCAT) extension terminal. The power supply CX1100-0004 establishes the possibility to connect E-Bus Terminal to the CPU Module.

Interestingly, EtherCAT offers several options for connecting conventional fieldbus systems to the CX1010: either as a CX1500 module directly at the CPU or as an EtherCAT device in terminal form. The PROFIBUS master is available either as a CX1500-M310 or as a EL6731 EtherCAT terminal. Both types offer the same performance characteristics - e.g. both support PROFIBUS DP-V2. In practice, this means that the PROFIBUS master can be positioned exactly where it is required within a machine. It no longer has to be implemented as a plug-in card in the IPC or a master controller in the control cabinet.

### **PLC, Motion Control, interpolation and visualisation**

As a top-hat rail IPC and in conjunction with the TwinCAT software from Beckhoff, the CX1010 offers the same functionality as large Industrial PCs. In terms of PLC, up to four virtual IEC 61131 CPUs can be programmed with up to four tasks each, with a minimum cycle time of 50 µs. All IEC 61131-3 languages can be used.

Moreover, all TwinCAT functionalities are available for Motion Control applications:

In theory, up to 256 axes can be controlled. In addition to simple point-to-point movements, more complex multi-axis functions such as "electronic gearbox", "cam plates" and "flying saw" can be implemented. In contrast to the CX1000, due to its higher CPU performance the CX1010 can now also execute interpolating 3D path movements and DIN66025 programs.

In addition to real-time execution of control tasks, the TwinCAT real-time kernel ensures that enough time remains for the user interface (HMI), to communicate with the real-time components via software interfaces such as ADS or OPC.

For the CX1010 the same basic principle applies: it is a programming tool for all controllers.

The complete programming of PLC, Motion Control and visualization is transferable to all PC controls from Beckhoff, which is reassuring in cases where it becomes apparent during a project that more processing power is required after all. In this case a system with higher performance can be used.

### **Basic CPU module**

[Basic CPU module \[► 12\]](#)

Further system interfaces or fieldbus connections can be added to the basic CPU module. The CPU module requires a CX1100 type power supply module.

All CX1500 fieldbus modules and all CX1100 power supply units from the CX1000 series can be used in combination with the CX1010.

The CX1100-0004 power supply unit offers a direct interface between the CX1010 and the EtherCAT Terminals. The combination of CX1010, EtherCAT and TwinCAT enables cycle and response times of less than 1 millisecond.

The CPU module is available in several variants. These relate to:

- System interface configuration: as an option, a DVI and two USB Interfaces can be added to the combination of the Ethernet RJ 45 port that is always present.

- Operating system: There is a choice between "Microsoft Windows CE.NET" or "Microsoft Windows XP Embedded".

- Pre-installed TwinCAT software: CX1010 can be pre-installed without a TwinCAT system, with TwinCAT CE PLC, TwinCAT CE NC PTP or TwinCAT CE NCI, or with the associated full version of the individual TwinCAT levels for PLC and Motion Control.

## System interfaces

[System interfaces \[► 21\]](#)

Further system interfaces for serial communication (2x RS 232 or RS422, RS485), 2 x USB 2.0 interfaces, video output (DVI +) , CF card reader/writer or audio signals can be ordered separately.

## Fieldbus interfaces

All CX1500 fieldbus modules and all CX1100 power supply units from the CX1000 series can be used in combination with the CX1010.

The fieldbus interfaces are currently available as master and slave versions for the following fieldbuses:

Beckhoff Lightbus, Profibus DP, CANopen, DeviceNet or SERCOS interface (only master)

The master fieldbus connections enable a CX1020 system to use Beckhoff fieldbus components (such as Bus Coupler, Bus Terminal Controller or Drive Technology) as local control components for complex systems.

Slave fieldbus connections enable the CX1020 system to be used as a subordinate distributed control system for complex or modular systems.

### Note:

Documentation describing the fieldbus connections is available separately.

## The software

In combination with the TwinCAT automation software, the CX1010 Industrial PC becomes a powerful IEC 61131-3 PLC with up to four user tasks. Additionally, Motion Control tasks can also be executed. Depending on the required cycle time, several servo axes can be controlled. Even special functions such as flying saw, electronic gearbox and cam plate can be realized.

The CX1010 system is programmed in the same way as other bus controllers:

## Remote programming via Ethernet

This option is used if the basic unit is equipped with "Windows CE.NET". In this case, the system is programmed via a laptop or a desktop PC, which is connected to the CX1020 via Ethernet (network or crossover cable). The programs are developed on the laptop with a standard TwinCAT software licence and then loaded into the target device.

## Visualization

The Beckhoff OPC server is available for interfacing with SCADA packets, if the two operating system variants "Windows CE.NET" or "Windows XP Embedded" are used. In other words, the CX1010 also offers straightforward visualization and simultaneous control in real-time on a single system.



## 2.3.2 Configurations

The Basic CPU-Module can be ordered with different hardware and software variations. As operating systems there are "Windows CE.NET" and "Windows XP Embedded" available. The TwinCAT automation software transforms a CX1020 system into powerful PLC and Motion Control system that can be operated with or without visualisation.

The order identifier of the basic CPU module is derived as follows:

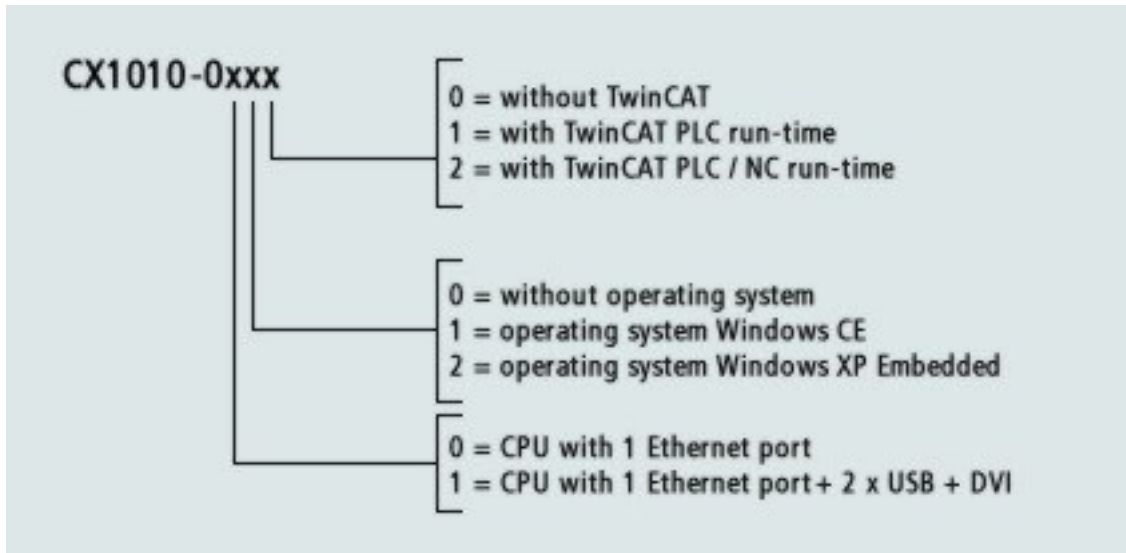

Following CX1020 configurations are available:

**Requirements**

Modul	DVI / USB	no operating system	Windows CE	Windows XPE	without TwinCAT	TwinCAT PLC Runtime	TwinCAT NC PTP Runtime
CX1010-0000	-	X	-	-	X	-	-
CX1010-0010	-	-	X	-	X	-	-
CX1010-0011	-	-	X	-	-	X	-
CX1010-0012	-	-	X	-	-	-	X
CX1010-0100	X	X	-	-	X	-	-
CX1010-0110	X	-	X	-	X	-	-
CX1010-0111	X	-	X	-	-	X	-
CX1010-0112	X	-	X	-	-	-	X
CX1010-0020	-	-	-	X	X	-	-
CX1010-0021	-	-	-	X	-	X	-
CX1010-0022	-	-	-	X	-	-	X
CX1010-0120	X	-	-	X	X	-	-
CX1010-0121	X	-	-	X	-	X	-
CX1010-0122	X	-	-	X	-	-	X

X1010 Systems with Windows XP Embedded require a Compact Flash card with a capacity of at least 1 GB.

**Note:**

For detailed information about the software images see the CX10x0 Software Documentation.

**2.3.3 Connections**

The basic CPU module is available with different hardware and software options. It is supplied from the power supply unit, so that only the connections are described here.

**Basic CPU module with 2 Ethernet RJ 45 interfaces:****RJ 45 interface (socket):**

Table 1: Assignment of the RJ45 interface:

PIN	Signal	Description
1	TD +	Transmit +
2	TD -	Transmit -
3	RD +	Receive +
4	connected	not used
5		
6	RD -	Receive -
7	connected	not used
8		

TD & RD are exchanged at the hubs or between two PCs.

**Schematic structure of the network components:**

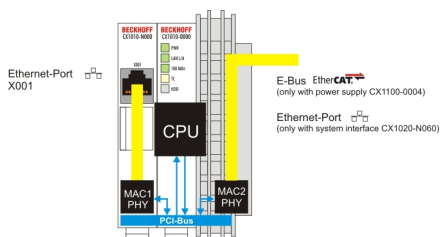

The CX1010 features two MAC blocks. The first one (MAC1) operates the left network interfaces for the standard IP network. This port is also used for PLC programming.

The second block (MAC2) operates the extended PC104 bus. The second physical network connection can be utilized via additional system interfaces. This requires either a CX1100-0004 power supply unit [▶ 36] or a CX1020-N060 system interface. A connection to the E-bus for EtherCAT terminals is realized via the power supply unit. The CX1010-N060 interface establishes the Ethernet connection, thereby making a further network interface available.

**Operating system perspective:**

The operating system only sees the connections for the network interface. The internal connection via the PC104 bus extension is shown as the second interface. If no expansion module is connected, the line is reported as not connected. If the CX1100-0004 power supply unit is connected, Windows XPe reports "restricted or no connection". This behavior is normal, since Windows itself does not use this interface, and therefore no IP address is allocated. If the CX1020-N060 extension is connected, the connection behaves like a 'normal' network port.



The network ports are only for communication with standard network. Do not connect to telecommunication circuits.

**Basic CPU module with DVI/USB interface:**

In addition to the Ethernet port, this basic module also features DVI/USB interfaces. The pin assignment of the basic CPU module with two USB and a DVI-I interface is explained under the associated CX1010-N 010 [▶ 23] system interface.

**Applicable to all basic CPU modules:**

**LED**

The green power LED (PWR) is on if the basic CPU module is connected correctly to a live power supply unit.

## Compact Flash slot

Further information can be found under [Compact Flash slot](#) [▶ 16].

## PC 104 Bus

The [PC 104 bus](#) [▶ 19] is a standardized bus with 104 ISA signals for compact embedded systems.

## Also see about this

📄 [CX1020-N060 connections](#) [▶ 29]

## 2.3.4 Battery compartment

The battery compartment is located on the left-hand side of the CPU module, between the two Ethernet ports.

It can be opened with the aid of a screwdriver (proceed carefully in order to avoid damage).

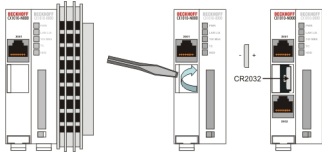

The battery is a CR2032 type from Panasonic

with the following specification:

Battery type	Electrical properties (at 20° C)		Standard charge	Dimensions		
	nominal voltage	nominal capacity	continuous load	Diameter	Height	Weight
<a href="https://infosys.beckhoff.com/content/1033/cx1010_hw/Resources/pdf/3220311051.pdf">https://infosys.beckhoff.com/content/1033/cx1010_hw/Resources/pdf/3220311051.pdf</a>	3.0 V	225 mAh	0.20 mA	20.0 mm	3.20 mm	3.1 g

### ⚠ DANGER

Replace Battery Part. No. CR2032 manufactured by Sanyo or Panasonic Only. Use of Another Battery May Present A Risk Of Fire Or Explosion. WARNING, Battery may explode if mistreated. Do Not Recharge, Disassemble or Dispose of in fire.



The battery must be changed every 5 years. Spare batteries can be ordered from Beckhoff Service. Battery-recycling: Used batteries must be disposed of in accordance with national electronics scrap regulations. Used batteries may contain harmful substances or heavy metal that can harm the environment and health. Batteries will be recycled. They contain important commodities as iron, zinc, nickel or manganese. The environment and Beckhoff thank for your understanding.

## 2.3.5 Compact Flash slot

A Compact Flash slot is provided at the front of module. This enables an additional Compact Flash memory medium (format I or II) to be operated. The change - in case of the Basic CPU module CF slot - is only allowed while the system is powered down - otherwise the system could crash. In case of using the CF-slot



extension (CXxxxx-A001) the CF card can be removed after signing out the media from the system. The card can be removed for maintenance or to extend the system storage capacity. The Compact Flash cards (CF cards) are available as accessories with different storage capacities.

As example the following pictures show the handling of the CF cards with a CX1000 system. Activating the eject mechanism below the slot with a screwdriver causes the card to be ejected by approx. 4 mm (FIGURE 1), so that it can be pulled out (FIGURE 2). If the card is pushed in (FIGURE 3), the eject mechanism will re-engage. The card is positioned correctly, if it is located approx. 1 mm lower than the front of the housing.



FIG1: Ejecting the CF card

FIG2: Removing the CF card

FIG3: Inserting the CF card

**NOTE**

The Compact Flash slot is a memory interface, not an I/O type CF slot.

## 2.3.6 Compact Flash card

The Compact Flash card (CF card) is a non-volatile memory medium.

Data to be retained in the event of a power failure should be saved on the CF card. The CF card operates similar to a hard disk.

### NOTE

It is recommended only use CF cards supplied by Beckhoff Automation GmbH. The CF cards are made for industrial use. They possess a higher number of read / write cycles and an enhance temperature range (up to + 85°C). A proper operation of the CX-System can only be guaranteed with the use of CF cards from Beckhoff Automation GmbH!

## 2.3.7 Adapter RAM Hardware address overview

available memory addresses CX1020: D0000-DFFFF (hex)

Base Address (hex)	End Address (hex)	Size(Bytes)(hex)	Access Type	Description
D0000	D0FFF	1000	R/W	CX1100-0002/3 Dual Ported RAM
D1000	D100F	10	R/W	CX1100 Auxiliary Control Block( LCD Display, misc. registers)
D1010	D101F	10	R/W	CX1100-0900 UPS Control Block
D2000	D3FFF	2000	R/W	CX1100 Non Volatile RAM
D4000	D5FFF	2000	R/W	CX1500-M310 Profibus Master DPRAM
D6000	D7FFF	2000	R/W	CX1500-M510 CANopen Master DPRAM
D8000	D9FFF	2000	R/W	CX1500-M520 DeviceNet Master DPRAM
DA000	DBFFF	2000	R/W	CX1500-M200 Lightbus Master DPRAM
DC000	DDFFF	2000	R/W	CX1500-M750 Sercos Master DPRAM

For some fieldbus connections (all Slave modules) the base addresses are mapped in the memory region upper DFFFF(hex). So this modules must be ordered with other base addresses. The same situation takes place if more than two or more master modules of same type are used (for more see note below). The order numbers for the modules are:

order number	alternative ISA-address
Master connection	
CX1500-Mxxx-0001	D4000
CX1500-Mxxx-0002	D6000
CX1500-Mxxx-0003	D8000
CX1500-Mxxx-0004	DA000
CX1500-Mxxx-0005	DC000
Slave connection	
CX1500-Bxxx-0001	D4000
CX1500-Bxxx-0002	D6000
CX1500-Bxxx-0003	D8000
CX1500-Bxxx-0004	DA000
CX1500-Bxxx-0005	DC000

Replace xxx with the following number for the requested fieldbus system:

- 200 for Lightbus
- 310 for Profibus
- 510 for CAN-open
- 520 for DeviceNet
- 750 for Sercos (only Master connection available)



Two connection modules (master or slave) can be used simultaneously. If more than two connections are needed call Beckhoff Automation GmbH for further information.

### 2.3.8 PC/104 Bus

The PC 104 bus is a standardized bus with 104 ISA signals for compact embedded systems.



For the functionality of the CX1020 modules eight further signals have been added ( here marked with color).

Table 2: Pin assignment of 16 Bit PC 104 Bus:

Pin Number	Row A	Row B	Row C <sup>4</sup>	Row D <sup>4</sup>
1	IOCHCHK*	GND	GND	GND
2	SD7	RESETDRV	SBHE*	MEMCS16*
3	SD6	+5V	LA23	IOCS16*
4	SD5	IRQ9	LA22	IRQ10
5	SD4	n.c. (+12V internal)	LA21	IRQ11
6	SD3	DRQ2	LA20	IRQ12
7	SD2	n.c. (+5V internal)	LA19	IRQ13
8	SD1	ENDXFR*	LA18	IRQ14
9	SD0	+12V	LA17	DACK0*
10	IOCHRDY	(KEY) <sup>2</sup>	MEMR*	DRQ0
11	AEN	SMEMW*	MEMW*	DACK5*
12	SA19	SMEMR*	SD8	DRQ5
13	SA18	IOW*	SD9	DACK6*
14	SA17	IOR*	SD10	DRQ6
15	SA16	DACK3*	SD11	DACK7*
16	SA15	DRQ3	SD12	DRQ7
17	SA14	DACK1*	SD13	+5V
18	SA13	DRQ1	SD14	MASTER*
19	SA12	REFRESH*	SD15	GND
20	SA11	SYSCLK	(KEY) <sup>2</sup>	GND
21	SA10	IRQ7	--	--
22	SA9	IRQ6	--	--
23	SA8	IRQ5	--	--
24	SA7	IRQ4	--	--
25	SA6	IRQ3	--	--
26	SA5	DACK2*	--	--
27	SA4	TC	--	--
28	SA3	BALE	--	--
29	SA2	+5V	--	--
30	SA1	OSC	--	--
31	SA0	GND	--	--
32	GND	GND	--	--

## Remarks:

1. B10 and C19 are key locations.
2. Signal timing and function are as specified in ISA specification.
3. Signal source/sink current differ from ISA values.
4. Negative voltages are not supported.
5. in the specification the pins are counted from 0 to 19

Assignment on the 8 additional pins

Pin number (yellow fields)	Row C	Row D
1	LAN TX-	LAN TX+
2	LAN RX-	LAN RX+
3	USB D-	USB D+
4	SMBDAT	SMBCLK

**Note:**

Further information to PC104 Bus can be found in the [https://infosys.beckhoff.com/content/1033/cx1010\\_hw/Resources/pdf/3220313995.pdf](https://infosys.beckhoff.com/content/1033/cx1010_hw/Resources/pdf/3220313995.pdf) or under <http://www.pc104.org>.

## 2.4 System interfaces

### 2.4.1 Technical Data

**Dimensions:**

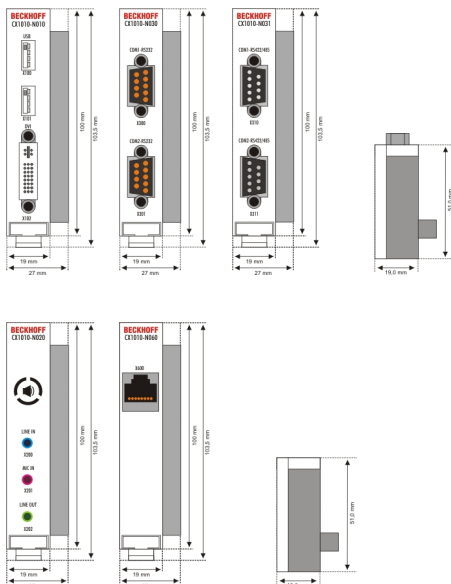

Like for the CX1000, a number of optional interface modules are available for the basic CX1010 CPU module that can be installed ex works. The following interfaces are available:

- CX1010-N010 DVI / USB Module
- CX1010-N020 Audio interfaces
- CX1010-N030/40 serial interface for RS232
- CX1010-N031/41 serial interface for RS422 / RS485
- CX1010-N060 Ethernet-interface

The CX1010-N010 option can be connected to Beckhoff Control Panels or standard monitors with DVI or VGA input via the DVI or USB interfaces. Devices such as printer, scanner, mouse, keyboard, mass storage, CR-RW etc. can be connected via the USB 2.0 interfaces. Multimedia capability is realized via the CX1010-N020 audio interface. The modules CX1010-N030 and CX1010-N040 offer a total of four serial RS232 interfaces with a maximum transfer speed of 115 kbaud. These four interfaces can be implemented in pairs as RS422/RS485, in which casethey are identified as CX1010-N031 and CX1010-N041 respectively. The system interfaces cannot be retrofitted or expanded in the field. They are supplied ex factory in the specified configuration and cannot be separated from the CPU module. The system interfaces run through the internal PC104 bus, so that further CX components can be connected. The power supply of the system interface modules is ensured via the internal PC104 bus.

Technical data	CX1010-N010	CX1010-N020	CX1010-N030 CX1010-N040	CX1010-N031 CX1010-N041
Interfaces	1 x DVI + 2 x USB 2.0 max. 100 mA per port	Line IN, MIC IN, Line OUT	1 x COM1+2, RS232 1 x COM3+4, RS232	1 x COM1+2, RS422/RS485 1 x COM3+4,RS422/ RS485
Connection type	DVI-I 29-pin socket + 2 USB Ports type A	3,5 mm socket for jack plug	2 x D-Sub plug 9- pin	2 x D-Sub plug 9- pin
Properties	DVI-I interface also carries out VGA signals (DVI-A)	built-in PC-Beeper Line OUT output, max. 200 mW, suitable for earphones	max. baud rate 115 kbaud, can not be used simultaneously with N031/N041	max. baud rate 115 kbaud, can not be used simultaneously with N030/N040
Power supply	via system bus (Through CX1100-000x power supply module)			
Dimensions	19 mm x 100 mm x 51 mm			
Operating temperature	0 °C ... +55 °C			
Storage temperature	-25 °C ... +85 °C			
Relative humidity	95% no condensations			
Vibration/Shock resistance	conforms to EN 60068-2-6 / EN 60068-2-27/29			
EMC resistance burst / ESD	conforms to EN 61000-6-2/EN 61000-6-4			
Protection class	IP 20			
weight	app. 80 g			

Technical data	CX1010-N060
Interfaces	1 x Ethernet 10/100 Mbit
Connection type	1 x RJ45
Properties	network connection for enhanced PC104 Bus
Power supply	via system bus (Through CX1100-000x power supply module)
Dimensions	19 mm x 100 mm x 51 mm
Operating temperature	0 °C ... +55 °C
Storage temperature	-25 °C ... +85 °C
Relative humidity	95% no condensations
Vibration/Shock resistance	conforms to EN 60068-2-6 / EN 60068-2-27/29
EMC resistance burst / ESD	conforms to EN 61000-6-2/EN 61000-6-4
Protection class	IP 20
weight	app. 80 g

## 2.4.2 CX1010-N010 connections

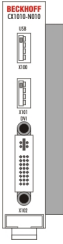

Fig. 2: CX1010-N010\_pic

This module features a DVI-I and two USB interfaces.

### DVI-I interface

The DVI-I interface transfers analog and digital data and is suitable for connection to analog graphics cards with 15 pin D-Sub connector and digital graphics cards with DVI-D output. The resolution at the screen or the Beckhoff Control Panel depends on the distance (maximum 5 m).

The DVI interface uses VGA signals, so that the connection of CRT VGA monitors to the CX1000 system using a DVI to VGA adapter is also possible. This adapter is available as an accessory.

### DVI-I socket:

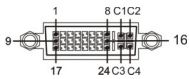

Pin	Assignment	Pin	Assignment	Pin	Assignment
1	TMDS Data 2-	9	TMDS Data 1-	17	TMDS Data 0-
2	TMDS Data 2+	10	TMDS Data 1+	18	TMDS Data 0+
3	TMDS Data 2/4 Shield	11	TMDS Data 1/3 Shield	19	TMDS Data 0/5 Shield
4	not connected	12	not connected	20	not connected
5	not connected	13	not connected	21	not connected
6	DDC Clock	14	+ 5V Power	22	TMDS Clock Shield
7	DDC Data	15	Ground ( +5V, Analog H/V Sync)	23	TMDS Clock +
8	Analog Vertical Sync	16	Hot Plug Detect	24	TMDS Clock -

### Assignment cross

Pin	Assignment
C1	Analog Red Video Out
C2	Analog Green Video Out
C3	Analog Blue Video Out
C4	Analog Horizontal Sync

Resolution at the monitor:

### NOTE

#### Resolution

Note the supported resolution. You can only use the listed resolution.

Resolution in Pixel	Distance of the interface from the monitor
1600 x 1200	5 m
1280 x 1024	5 m
1024 x 768	5 m
800 x 600	5 m
640 x 480	5 m

#### USB interface:

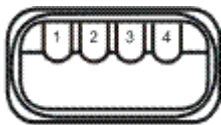

The USB socket is a type A socket. The USB interface complies to USB 2.0 specification

Pin	Assignment	Typical Assignment
1	VBUS	Red
2	D-	White
3	D+	Green
4	GND	Black
Shell	Shield	Drain Wire

## 2.4.3 CX1020-N020 connections

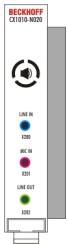

Fig. 3: CX1010-N020\_pic

This system interface provides the audio interface for the CX1020 system. Two inputs, "LINE IN" and "MIC IN", are available. The "LINE OUT" connection is used as output for audio signals. It can also be used for connecting headphones with a maximum output of 200 mW. It also features a PC beeper. The audio interfaces are accessed via the operating system. "Windows XPe" offers an option for switching the audio module to surround mode.

The 3.5 mm sockets are designed for jack plugs.

#### Standard / stereo mode:

The audio module operates in stereo mode as standard, using stereo outputs/inputs and a single-channel input for the microphone. The inputs should be connected as indicated. The pin assignments are described below.



**Line In / Line Out stereo jack plugs:**



Table 3: Pin assignment Line In /Line Out:

Signal	Assignment
L	left channel
R	right channel
Ground	ground

The left channel is transferred via the tip of the jack plug, the right channel via the first ring. The remainder of the sleeve is used for signal ground.

**Mic In mono jack plug:**



The only existing channel is transferred via the tip, the remainder of the sleeve is used for signal ground.

**2.4.4 CX1010-N030/40 connections**

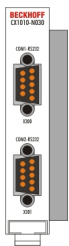

The CX1010-N030 system interface features two RS232 interfaces, COM1 and COM2 (9 pin Sub-D plug connector). If there is need for more than two serial interfaces two further RS232 interfaces, COM3 and COM4 (9 pin Sub-D plug connector) can be added to the system via the system interface CX1010-N40. The maximum baud rate on all channels is 115 kBit. The pin assignment for all interfaces is equal and described below. The interface parameter can be set in the operating system or in the PLC program.

**RS232 COM interface (connector):**

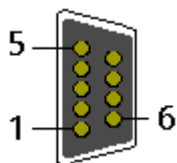

Fig. 4: RS232\_Stecker

Table 4: Pin assignment COM interface:

PIN	Signal	Type	Description
1	DCD	Signal in	Data Carrier Detected
2	RxD	Signal in	Receive Data
3	TxD	Signal out	Transmit Data
4	DTR	Signal out	Data Terminal Ready
5	GND	Ground	Ground
6	DSR	Signal in	Dataset Ready
7	RTS	Signal out	Request to Send
8	CTS	Signal in	Clear to Send
9	RI	Signal in	Ring Indicator



The system interface CX1010-N30 can only be used instead and not simultaneously with system interface CX1010-N031. The system interface CX1010-N40 can only be used instead and not simultaneously with system interface CX1010-N041.

## 2.4.5 CX1020-N031/41 connections

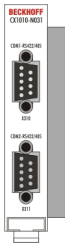

Fig. 5: CX1010-N031\_41\_pic

The CX1010-N031 system interface features two RS422 / RS 485 interfaces, COM1 and COM2 (9 pin Sub-D plug connector). If there is need for more than two serial interfaces two further RS422 / RS485 interfaces, COM3 and COM4 (9 pin Sub-D plug connector) can be added to the system via the system interface CX1010-N41. The maximum baud rate on all channels is 115 kBit. The pin assignment for all interfaces is equal and described below. The interface parameter can be set in the operating system or in the PLC program.

### RS232 COM interface (connector):

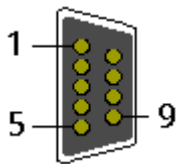

Fig. 6: RS232\_B

Table 5: Pin assignment COM interface:

PIN	Signal	Type	Description
2	TxD+	Data-Out +	Transmit 422
3	RxD+	Data-In +	Receive 422
5	GND	Ground	Ground
6	VCC	VCC	+5V
7	TxD-	Data-Out -	Transmit 422
8	RxD-	Data-In -	Receive 422

For RS 485 Pin 2 and 3 ( Data +) as well as Pin7 and 8 (Data -) have to be connected..

**Setting the interface parameter**

If the system interface CX1010-N031/N041 resides at the end of the CX1010-system block, it is easy to access the dip switches. The dip switches for the configuration of the RS485/422 interfaces can be found at the left side of the module. If you remove the grey cover you can see the switch:

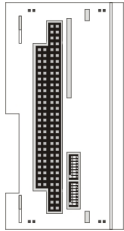

The upper switch sets the parameters for the upper interface, the lower switch sets the parameter for the lower interface. The system must be powered down, if the settings of the switches are changed! The settings for default use should be mentioned by ordering the interface module.

**Settings DIP switches RS485:**

*Table 6: RS485 without Echo, End-Point ( Terminated) DEFAULT setting*

DIP	Status	Function
1	off	Echo on
2	on	Echo off
3	on	Auto send on
4	off	Always send on
5	on	Auto receive on
6	off	Always receive on
7	on	Term on
8	on	Term on

*Table 7: RS485 with Echo, End-Point ( Terminated)*

DIP	Status	Function
1	on	Echo on
2	off	Echo off
3	on	Auto send on
4	off	Always send on
5	off	Auto receive on
6	on	Always receive on
7	on	Term on
8	on	Term on

Table 8: RS485 without Echo, Drop-Point ( without Termination)

DIP	Status	Function
1	off	Echo on
2	on	Echo off
3	on	Auto send on
4	off	Always send on
5	off	Auto receive on
6	on	Always receive on
7	off	Term on
8	off	Term on

Table 9: RS485 with Echo, Drop-Point ( without Termination)

DIP	Status	Function
1	on	Echo on
2	off	Echo off
3	on	Auto send on
4	off	Always send on
5	off	Auto receive on
6	on	Always receive on
7	off	Term on
8	off	Term on

**Setting DIP-Switches RS422:**

Table 10: RS422 full duplex end point

DIP	Status	Function
1	on	Echo on
2	off	Echo off
3	off	Auto send on
4	on	Always send on
5	off	Auto receive on
6	on	Always receive on
7	on	Term on
8	on	Term on



The system interface CX1010-N31 can only be used instead and not at the same time with system interface CX1010-N030. The system interface CX1010-N41 can only be used instead and not at the same time with system interface CX1010-N040.

**Also see about this**

 Removal and disposal [▶ 88]

## 2.4.6 CX1020-N060 connections

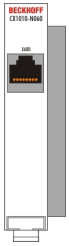

Fig. 7: CX1010-N060\_pic

The CX1010-N060 system interface provides a further network interface. It can only be used if the CX1100-0004 power supply unit is not connected, since in this case the only internal interface available is used for connecting the Ethernet port. (Details see [Basic module description](#) [▶ 14].)

### RJ 45 interface (socket):



Table 11: Assignment of the RJ45 interface, Port 1:

PIN	Signal	Description
1	TD +	Transmit +
2	TD -	Transmit -
3	RD +	Receive +
4	connected	not used
5		
6	RD -	Receive -
7	connected	not used
8		

TD & RD are exchanged at the hubs or between two PCs.

### NOTE

The CX1020-N060 system interface may only be mounted on the right, directly at the CPU module. The setup is shown in the following figures.

### Proper mounting position:

The interface is located between the CPU module and the power supply unit.

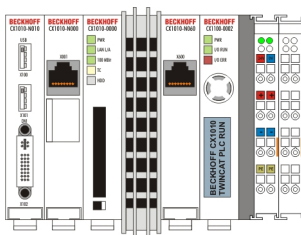

### Incorrect mounting position:

The interface is located to the left of the CPU module, in series with the other system interfaces.

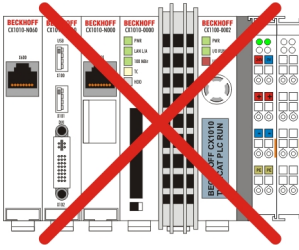

**NOTE**

The connected network cable must not have a length of more than 15 meters!



The CX1010-N060 system interface can only be used in place of the CX1100-0004 power supply unit, not at the same time.

## 2.5 Netzteile

### 2.5.1 CX1100-000x | Power supply units and I/O interfaces

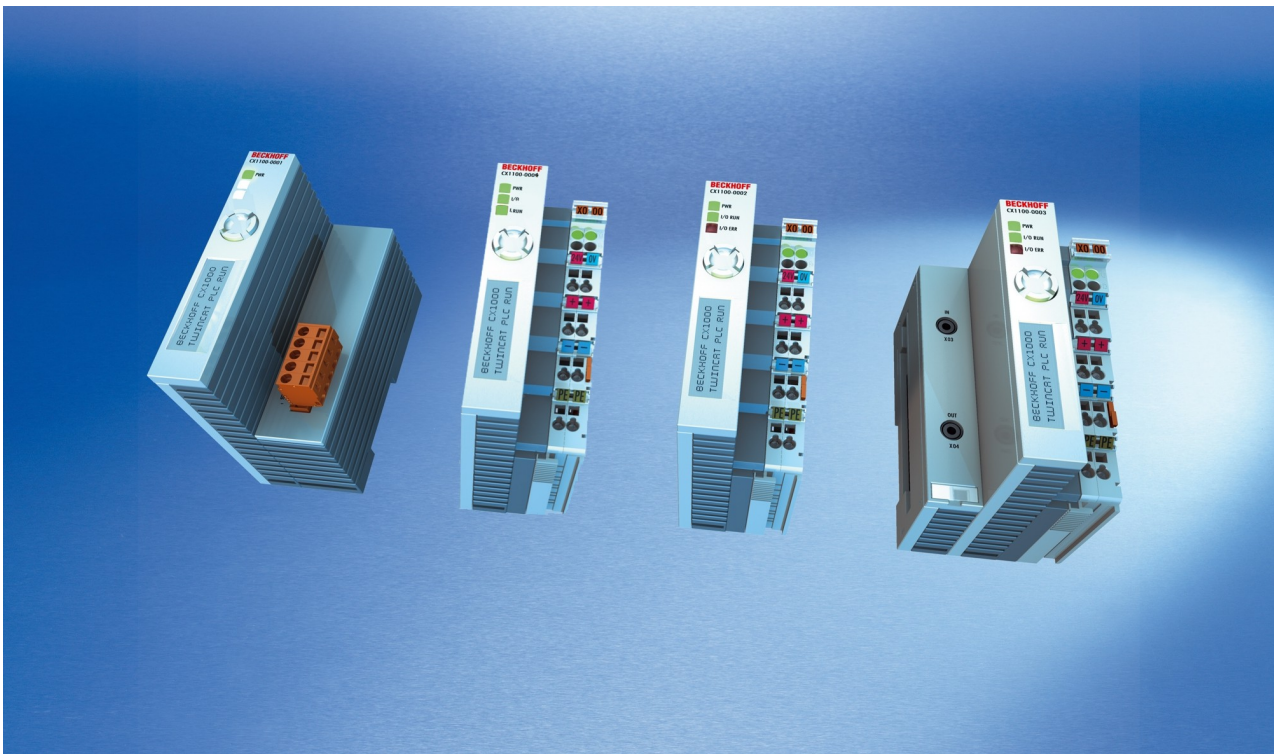

A choice of four power supply modules is available for use with a CX10x0 system. The power supply of all other system components is ensured via the internal PC104 bus; no separate supply lines are required. However, the CX1100 components offer further important characteristics that go beyond a pure power supply: an integrated NOVRAM enables the fail-safe storage of process data, an LCD display with two lines of 16 characters each is used for displaying system and user messages. A 4 + 1 keypad enables user input without additional keyboard or input panel. Local I/O signals are connected via the CX1100-0002 power supply variant, to which all Beckhoff Bus Terminals can be connected, or via CX1100-0003, which in addition to the Bus Terminals enables the connection of Extension Box IExxxx type Beckhoff Fieldbus Box modules. The option to connect Bus Terminals or a fieldbus Box creates a control system with a very variable, expandable I/O level with large signal variety. The I/O data are stored in a DPRAM, which is accessible by the CPU via the system bus. The power supply units of the CX system can be changed in the field: If, for example, local I/O via Bus Terminals is required, CX1100-0001 can be replaced with CX1100-0002 in the

field. EtherCAT terminals can be connected via the CX1100-0004 power supply unit. The I/O data are stored directly in the main memory of the CX1100-0004 CPU; a DPRAM is no longer required. The CX1100-0004 power supply unit for EtherCAT terminals can *not* be connected in conjunction with the basic CX1000 CPU module.

The technical data are provided with the individual power supply unit specifications:

- [CX1100-0001](#) [[▶ 31](#)] (no field bus)
- [CX1100-0002](#) [[▶ 32](#)] (K-Bus)
- [CX1100-0012](#) [[▶ 33](#)] (K-Bus for CX1030 and CX10x0 for alternative installation positions)
- [CX1100-0003](#) [[▶ 34](#)] (K-Bus, IP-Link)
- [CX1100-0013](#) [[▶ 35](#)] (K-Bus, IP-Link for CX1030 and CX10x0 for alternative installation positions)
- [CX1100-0004](#) [[▶ 36](#)] (E-Bus)
- [CX1100-0014](#) [[▶ 37](#)] (E-Bus for CX1030 and CX10x0 for alternative installation positions)

An overview of the power supply architecture and a detailed description of the general system components such as GCB, ACB, NOVDRAM, display and keypad can be found in the documentation for the power supply units.

## 2.5.2 Technical data CX1100-0001

### Dimensions:

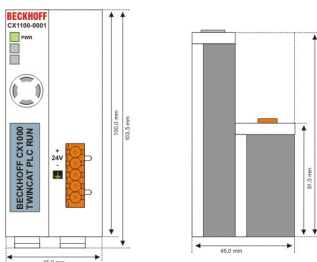

One of power supply modules can be selected for a CX10x0 system. The power supply of all other system components is ensured via the internal PC104 bus; no separate supply lines are required. However, the CX1100 components offer further important characteristics that go beyond a pure power supply: an integrated NOVDRAM enables the fail-safe storage of process data, an LCD display with two lines of 16 characters each is used for displaying system and user messages.

The power supply CX1100-N001 has no I/O interfaces.

Technical data	CX1100-0001
Power supply	24 V <sub>DC</sub> (-15%/+20%) To meet the UL requirements use a 4 A fuse or a power supply that has to satisfy <i>NEC class 2!</i>  
Dielectric strength	500 V <sub>eff</sub> (supply / internal electronics)
Max. power consumption	2.5 W
Recommended fuse at 24 V	4 A
K-bus connection	-
E-bus connection	-
IP-Link connection	-
K-bus power supply to	-
connection type	1 x Open Pluggable Connector, 5-pin
NOVRAM	8 kByte
Display	FSTN display 2 lines x 16 characters of text, illuminated
I/O-DPRAM	-
Diagnose LED	1 x PWR
Dimensions (W x H x D)	45 mm x 100 mm x 91 mm
weight	app.180 g
operating/storage temperature	0° C ... +55° C / -25° C ... +85° C
Relative humidity	95% no condensation
Vibration/shock resistance	conforms to EN 60068-2-6 / EN 60068-2-27/29
EMC resistance burst / ESD	conforms to EN 61000-6-2 / EN 61000-6-4
protection class	IP 20

### 2.5.3 Technical data CX1100-0002

**Dimensions:**

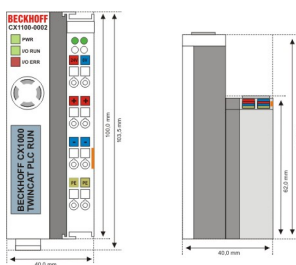

One of four power supply modules can be selected for a CX10x0 system. The power supply of all other system components is ensured via the internal PC/104 bus; no separate supply lines are required. However, the CX1100 components offer further important characteristics that go beyond a pure power supply: an integrated NOVRAM enables the fail-safe storage of process data, an LC display with two lines of 16 characters each is used for displaying system and user messages.



Technical data	CX1100-0002
Power supply	24 V <sub>DC</sub> (-15%/+20%) To meet the UL requirements use a 4 A fuse or a power supply that has to satisfy <i>NEC class 2!</i>  
Dielectric strength	500 V <sub>eff</sub> (supply / internal electronics)
Max. power consumption	3.5 W
Recommended fuse at 24 V	4 A
K-bus connection	yes (adapter terminal)
E-bus connection	-
IP-Link connection	-
K-bus power supply to	1.75 A
connection type	Cage-Clamp (adapter terminal)
NOVRAM	8 kByte
Display	FSTN display 2 lines x 16 characters of text, illuminated
I/O-DPRAM	2 kByte
Diagnose LED	1 x PWR, 1 x I/O Run, 1 x I/O Err
Dimensions (W x H x D)	40 mm x 100 mm x 91 mm
weight	app.250 g
operating/storage temperature	0° C ... +55° C / -25° C ... +85° C
Relative humidity	95% no condensation
Vibration/shock resistance	conforms to EN 60068-2-6 / EN 60068-2-27/29
EMC resistance burst / ESD	conforms to EN 61000-6-2 / EN 61000-6-4
protection class	IP 20

## 2.5.4 Technical data CX1100-0012

### Dimensions:

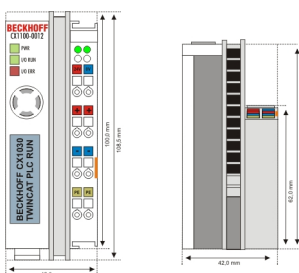

One of four power supply modules can be selected for a CX10x0 system. The power supply of all other system components is ensured via the internal PC/104 bus; no separate supply lines are required. However, the CX1100 components offer further important characteristics that go beyond a pure power supply: an integrated NOVRAM enables the fail-safe storage of process data, an LC display with two lines of 16 characters each is used for displaying system and user messages.

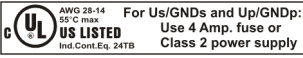
Technical data	CX1100-0012
Power supply	24 V <sub>DC</sub> (-15%/+20%) To meet the UL requirements use a 4 A fuse or a power supply that has to satisfy <i>NEC class 2!</i>  
Dielectric strength	500 V <sub>eff</sub> (supply / internal electronics)
Max. power consumption	3.5 W
Recommended fuse at 24 V	4 A
K-bus connection	yes (adapter terminal)
E-bus connection	-
IP-Link connection	-
K-bus power supply to	1.75 A
connection type	Cage-Clamp (adapter terminal)
NOVRAM	8 kByte
Display	FSTN display 2 lines x 16 characters of text, illuminated
I/O-DPRAM	2 kByte
Diagnose LED	1 x PWR, 1 x I/O Run, 1 x I/O Err
Dimensions (W x H x D)	42 mm x 109 mm x 92 mm
weight	app.250 g
operating/storage temperature	0° C ... +55° C / -25° C ... +85° C
Relative humidity	95% no condensation
Vibration/shock resistance	conforms to EN 60068-2-6 / EN 60068-2-27/29
EMC resistance burst / ESD	conforms to EN 61000-6-2 / EN 61000-6-4
protection class	IP 20

## 2.5.5 Technical data CX1100-0003

### Dimensions:

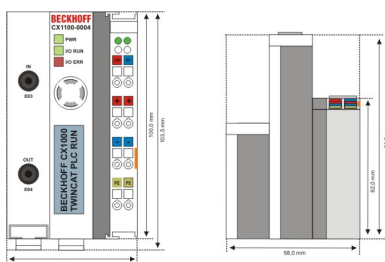

One of four power supply modules can be selected for a CX10x0 system. The power supply of all other system components is ensured via the internal PC/104 bus; no separate supply lines are required. However, the CX1100 components offer further important characteristics that go beyond a pure power supply: an integrated NOVRAM enables the fail-safe storage of process data, an LC display with two lines of 16 characters each is used for displaying system and user messages.

Technical data	CX1100-0003
Power supply	24 V <sub>DC</sub> (-15%/+20%) To meet the UL requirements use a 4 A fuse or a power supply that has to satisfy <i>NEC class 2!</i>  
Dielectric strength	500 V <sub>eff</sub> (supply / internal electronics)
Max. power consumption	4 W
Recommended fuse at 24 V	4 A
K-bus connection	yes (adapter terminal)
E-bus connection	-
IP-Link connection	yes
K-bus power supply to	1.75 A
connection type	Cage-Clamp (adapter terminal)
NOVRAM	8 kByte
Display	FSTN display 2 lines x 16 characters of text, illuminated
I/O-DPRAM	4 kByte
Diagnose LED	1 x PWR, 1 x I/O Run, 1 x I/O Err
Dimensions (W x H x D)	58 mm x 100 mm x 91 mm
weight	app.350 g
operating/storage temperature	0° C ... +55° C / -25° C ... +85° C
Relative humidity	95% no condensation
Vibration/shock resistance	conforms to EN 60068-2-6 / EN 60068-2-27/29
EMC resistance burst / ESD	conforms to EN 61000-6-2 / EN 61000-6-4
protection class	IP 20

## 2.5.6 Technical data CX1100-0013

### Dimensions:

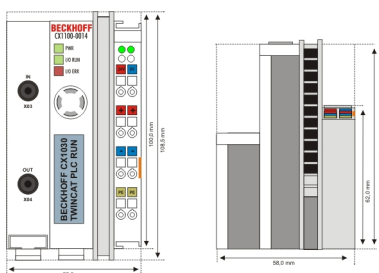

One of four power supply modules can be selected for a CX10x0 system. The power supply of all other system components is ensured via the internal PC/104 bus; no separate supply lines are required. However, the CX1100 components offer further important characteristics that go beyond a pure power supply: an integrated NOVRAM enables the fail-safe storage of process data, an LC display with two lines of 16 characters each is used for displaying system and user messages.

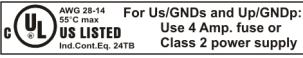
Technical data	CX1100-0013
Power supply	24 V <sub>DC</sub> (-15%/+20%) To meet the UL requirements use a 4 A fuse or a power supply that has to satisfy <i>NEC class 2!</i> 
Dielectric strength	500 V <sub>eff</sub> (supply / internal electronics)
Max. power consumption	4 W
Recommended fuse at 24 V	4 A
K-bus connection	yes (adapter terminal)
E-bus connection	-
IP-Link connection	yes
K-bus power supply to	1.75 A
connection type	Cage-Clamp (adapter terminal)
NOVRAM	8 kByte
Display	FSTN display 2 lines x 16 characters of text, illuminated
I/O-DPRAM	4 kByte
Diagnose LED	1 x PWR, 1 x I/O Run, 1 x I/O Err
Dimensions (W x H x D)	58 mm x 109 mm x 92 mm
weight	app.350 g
operating/storage temperature	0° C ... +55° C / -25° C ... +85° C
Relative humidity	95% no condensation
Vibration/shock resistance	conforms to EN 60068-2-6 / EN 60068-2-27/29
EMC resistance burst / ESD	conforms to EN 61000-6-2 / EN 61000-6-4
protection class	IP 20

## 2.5.7 Technical data CX1100-0004

### Dimensions:

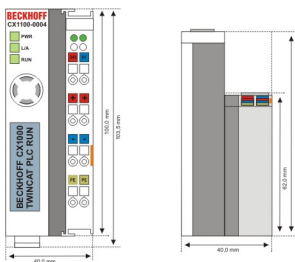

With the CX1100-0004 power supply EtherCAT Terminals can be connected to the CX1020-System. With CX1100-0004 the I/O data are stored directly in the main memory of the CPU; a DPRAM is no longer required. The CX1100-0004 power supply unit for EtherCAT Terminals can only be connected in conjunction with the basic CPU modules CX1010/CX1020/CX1030. The combination with CX1000/CX1001 is **not** possible.

Technical data	CX1100-0004
Power supply	24 V <sub>DC</sub> (-15%/+20%) To meet the UL requirements use a 4 A fuse or a power supply that has to satisfy <i>NEC class 2!</i>  
Dielectric strength	500 V <sub>eff</sub> (supply / internal electronics)
Max. power consumption	3.5 W
Recommended fuse at 24 V	4 A
K-bus connection	-
E-bus connection	yes (adapter terminal)
IP-Link connection	-
E-bus power supply to	2 A
connection type	Cage-Clamp (adapter terminal)
NOVRAM	8 kByte
Display	FSTN display 2 lines x 16 characters of text, illuminated
I/O-DPRAM	-
Diagnose LED	1 x PWR, 1 x L/A Run, 1 x RUN
Dimensions (W x H x D)	40 mm x 100 mm x 91 mm
weight	app.250 g
operating/storage temperature	0° C ... +55° C / -25° C ... +85° C
Relative humidity	95% no condensation
Vibration/shock resistance	conforms to EN 60068-2-6 / EN 60068-2-27/29
EMC resistance burst / ESD	conforms to EN 61000-6-2 / EN 61000-6-4
protection class	IP 20

## 2.5.8 Technical data CX1100-0014

### Dimensions:

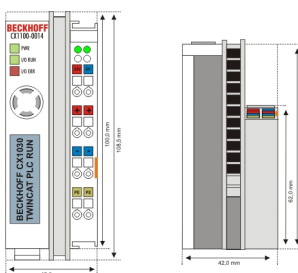

The CX1100-0014 power supply is designed for CX1030.

With the CX1100-0014 power supply EtherCAT Terminals can be connected to the CX10x0-System. With CX1100-0004 the I/O data are stored directly in the main memory of the CPU; a DPRAM is no longer required. The CX1100-0014 power supply unit for EtherCAT Terminals can *not* be connected in conjunction with the basic CX1000 CPU module.

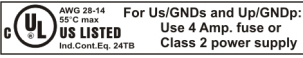
Technical data	CX1100-0014
Power supply	24 V <sub>DC</sub> (-15%/+20%) To meet the UL requirements use a 4 A fuse or a power supply that has to satisfy <i>NEC class 2!</i> 
Dielectric strength	500 V <sub>eff</sub> (supply / internal electronics)
Max. power consumption	3.5 W
Recommended fuse at 24 V	4 A
K-bus connection	-
E-bus connection	yes (adapter terminal)
IP-Link connection	-
E-bus power supply to	2 A
connection type	Cage-Clamp (adapter terminal)
NOVRAM	8 kByte
Display	FSTN display 2 lines x 16 characters of text, illuminated
I/O-DPRAM	-
Diagnose LED	1 x PWR, 1 x L/A Run, 1 x RUN
Dimensions (W x H x D)	42 mm x 109 mm x 92 mm
weight	app.250 g
operating/storage temperature	0° C ... +55° C / -25° C ... +85° C
Relative humidity	95% no condensation
Vibration/shock resistance	conforms to EN 60068-2-6 / EN 60068-2-27/29
EMC resistance burst / ESD	conforms to EN 61000-6-2 / EN 61000-6-4
protection class	IP 20

## 2.5.9 CX1100-0001 connections

This power supply unit does not have an I/O interface. The power supply is therefore connected through the 5-pin open pluggable connector. The power supply unit supplies all further system components with a voltage of 24 V DC (-15 %/+20%) via the PC104 bus. The dielectric strength of the power supply unit is 500 V<sub>rms</sub>.

The integrated NOVRAM permits storage of process data that is safe against power failure.

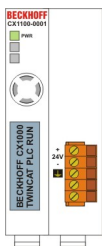

Table 12: Pin Allocation Open Style Connector:

Pin	Assignmnet
1	+24 V DC
2	0 V DC
3	GROUND
4	reserved / don't use
5	reserved / don't use

**LED:**

With proper connection of the power supply unit and with power supply turned on, the power LED (PWR) lights up green. In the case of a short-circuit, it lights up red.

**2.5.10 CX1100-00x2 connections**

This power supply unit is equipped with an I/O interface, which permits connection of the Beckhoff Bus Terminals. The power is supplied via the upper spring-loaded terminals labelled “24V” and “0V”. The supply voltage feeds the CX system and supplies a voltage of 24 V DC (-15 %/+20%) to the Bus Terminals via the K-Bus. The dielectric strength of the power supply unit is 500 V<sub>rms</sub>. Since the K-Bus does no more than pass data on, a further power supply is necessary for the Bus Terminals. This is provided by means of the power contacts, which are not connected to the power supply. The integrated NOVRAM permits storage of process data that is safe against power failure.

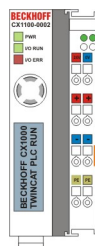

CX1100-0002 for CX1000, CX1010 und CX1020

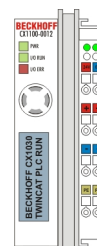

CX1100-0012 for CX1030

**LED:**

With proper connection of the power supply unit and with power supply turned on, the power LED (PWR) lights up green. In the case of a short-circuit, it lights up red.

The I/O LEDs display the operation status of the Bus Terminals. Error-free start-up of the configuration is signalled by the red "I/O ERR" LED being extinguished. If the "I/O ERR" LED blinks, an error in the area of the terminals is indicated. The error code can be determined from the frequency and number of blinks.

**PE power contacts**

The "PE" power contact must not be used for other potentials.

**2.5.11 CX1100-00x3 connections**

This power supply unit permits not only the connection of the Beckhoff Bus Terminals, but also the serial connection of the Beckhoff fieldbus box modules of the type extension box IExxxx. The power is supplied via the upper spring-loaded terminals labeled “24V” and “0V”.

The supply voltage feeds the CX system and, over the K-Bus, the Bus Terminals. Since the K-Bus does no more than pass data on, a further power supply is necessary for the Bus Terminals. This is provided by means of the power contacts, which are not connected to the power supply.

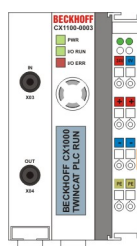

CX1100-0003 for CX1000, CX1010 und CX1020

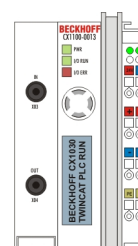

CX1100-0013 for CX1030

**Fieldbus connection:**

Plug the IP link connector into the respective connections, i.e. one fibre-optic cable each into IN (x03) and OUT (x04). You then connect the other end with the corresponding IP link interface of the extension box. The connection must be made so that the output of the fieldbus connection is connected to the input of the extension box and vice versa.

**LED:**

With proper connection of the power supply unit and with power supply turned on, the power LED (PWR) lights up green. In the case of a short-circuit, it lights up red. The I/O LEDs display the operation status of the Bus Terminals. Error-free start-up of the configuration is signaled by the red "I/O ERR" LED being extinguished. If the "I/O ERR" LED blinks, an error in the area of the terminals is indicated. The error code can be determined from the frequency and number of blinks.

**PE power contacts**

The "PE" power contact must not be used for other potentials.

**2.5.12 CX1100-00x4 connections**

This power supply unit is equipped with an I/O interface, which permits connection of the Beckhoff Bus Terminals. The power is supplied via the upper spring-loaded terminals labeled "24V" and "0V". The supply voltage feeds the CX system and supplies a voltage of 24 V DC (-15 %/+20%) to the Bus Terminals via the E-Bus. The dielectric strength of the power supply unit is 500 V<sub>rms</sub>. Since the E-Bus does no more than pass data on, a further power supply is necessary for the Bus Terminals. This is provided by means of the power contacts, which are not connected to the power supply. The integrated NOVRAM permits storage of process data that is safe against power failure.

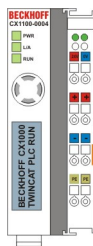

CX1100-0004 for CX1000, CX1010 und CX1020

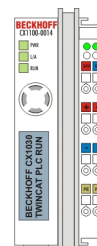

CX1100-0014 for CX1030

**LED:**

With proper connection of the power supply unit and with power supply turned on, the power LED (PWR) lights up green. In the case of a short-circuit, it lights up red.

**PE power contacts**

The "PE" power contact must not be used for other potentials.



This power supply is designed for use with CX1020 systems only. Operation with CX1000 systems is not possible because the EtherCAT protocol is not implemented / designed in the hardware of the CX1000 systems.



The power supply CX1100-0004 can only be used instead and not simultaneously with system interface CX1020-N060.

**NOTE**

It is important to keep attention to the hardware revision of the power supply. Power supplies with a hardware revision > 2.0 only work with CX1020 systems with a hardware revision > 2.1 !



## 2.5.13 LC Display

The LC Display of the power supply units has two rows of 16 characters each and is used for displaying system and user messages.

### "Index-Group/Offset" Specification for the LC Display

ADS Port 300

Index Group	Index Offset	Access	Data type	Phys. unit	Def. range	Description	Remarks
0x0000500 0 + DeviceID	0xFFFF90F F	R&W				Cursor OFF	
0x0000500 0 + DeviceID	0xFFFF91F F	R&W				Cursor ON	
0x0000500 0 + DeviceID	0xFFFF92F F	R&W				Cursor blink OFF	
0x0000500 0 + DeviceID	0xFFFF93F F	R&W				Cursor blink ON	
0x0000500 0 + DeviceID	0xFFFF94F F	R&W				Display OFF	
0x0000500 0 + DeviceID	0xFFFF95F F	R&W				Display ON	
0x0000500 0 + DeviceID	0xFFFF96F F	R&W				Backlight OFF	
0x0000500 0 + DeviceID	0xFFFF97F F	R&W				Backlight ON	
0x0000500 0 + DeviceID	0xFFFFA0F F	R&W				Write Text line 1	
0x0000500 0 + DeviceID	0xFFFF00F F	R&W				Write Text line 2	

## 3 Transport

### 3.1 Unpacking, installation and transport

The specified storage conditions must be adhered to (see "[Technical data \[► 12\]](#)").

#### Dimensions and weight of the individual modules:

Dimensions (W x H x D): 19 x 100 x 91 mm (system interface) , 96 x 112 x 99 mm (basic module) and 58 x 100 x 91 mm (power supply unit with I/O interface)

Weight: 80 g (system interface) to 550 g (basic module)

#### Unpacking

Proceed as follows to unpack the unit:

1. Remove packaging.
2. Do not discard the original packaging. Keep it for future relocation.
3. Check the delivery for completeness by comparing it with your order.
4. Please keep the associated paperwork. It contains important information for handling the unit.
5. Check the contents for visible shipping damage.
6. If you notice any shipping damage or inconsistencies between the contents and your order, you should notify Beckhoff Service.

#### NOTE

During transport in cold conditions, or if the unit is subjected to extreme temperature swings, condensation on and inside the unit must be avoided. Prior to operation, the unit must be allowed to slowly adjust to room temperature. Should condensation occur, a delay time of approximately 12 hours must be allowed before the unit is switched on.

#### Installation

The devices are designed for installation in control cabinets. You will find installation instructions in the chapter mechanical mounting.

#### Shipping and relocation

Despite the robust design of the unit, the components are sensitive to strong vibrations and impacts. During transport, your computer should therefore be protected from excessive mechanical stress. Therefore, please use the original packaging.

# 4 Assembly and connecting

## 4.1 Mechanical assembly

### 4.1.1 Dimensions

The CX1000 product range is characterized by small overall installed size and high modularity. For project planning purposes, a CPU module, a power supply unit and the associated system interfaces and fieldbus interfaces have to be provided. The overall width of the application is made up of the individual modules. With a height of 100 mm, the module dimensions exactly match those of the Beckhoff Bus Terminals. Together with the lowered connector surfaces, this means that it can be used in a standard terminal box with a height of 120 mm.

**NOTE**

To ensure cooling to the device in operation it is important keep the safety distances. Details see installation position below.

#### CX1010 Basic CPU-module:

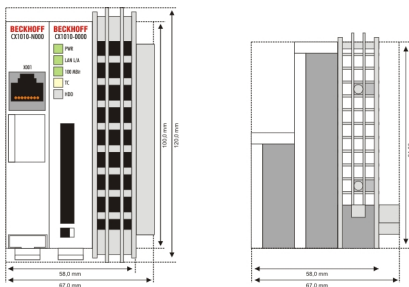

#### CX1010-N0x0 System interfaces:

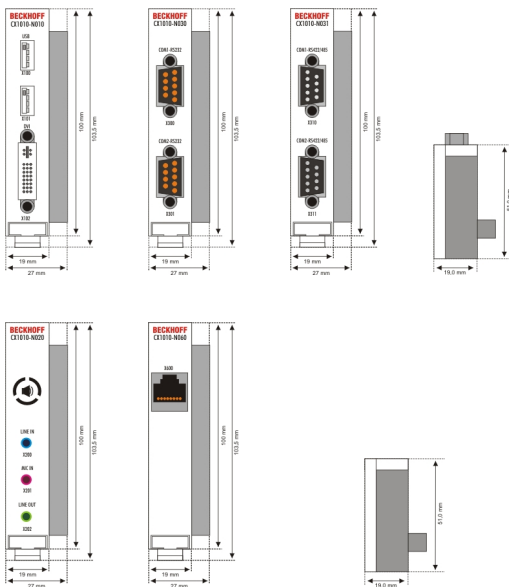

#### CX1100-000x power supply units:

##### CX1100-0001

power supply without I/O-interface

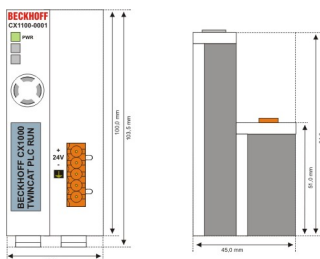

**CX1100-0002**

power supply with I/O-interface (K-Bus-connection)

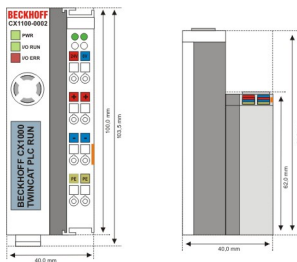

Abmessungen in mm: 39 x 100 x 91

**CX1100-0003**

power supply with I/O-interface (K-Bus-connection and IP Link)

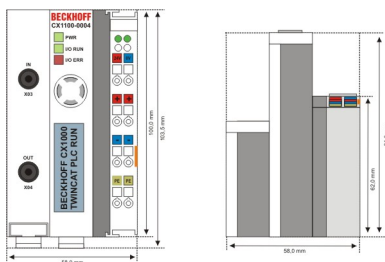

Abmessungen in mm: 58 x 100 x 91

**CX1100-0004**

power supply with I/O-interface (E-Bus-connection)

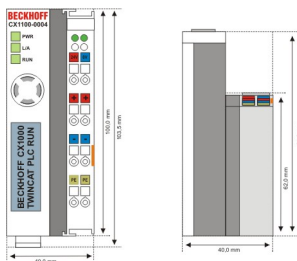

**CX1100-09x0 UPS Modules:**

**CX1100-0900**

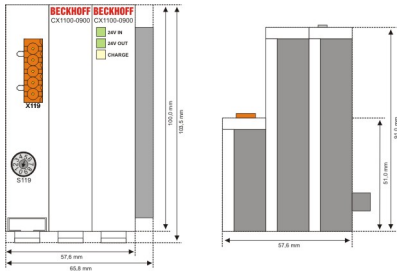

**CX1100-0910**

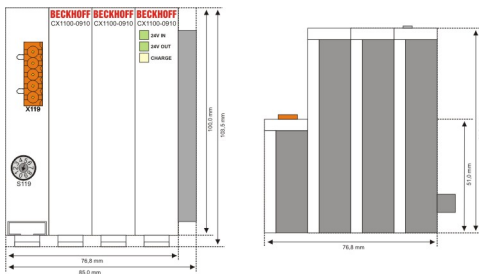

**CX1100-0920**

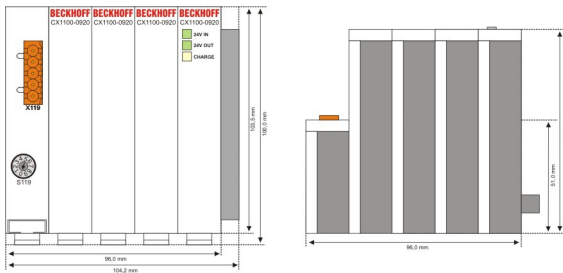

**CX1500-Mxxx und CX1500-Bxxx fieldbus connections**

All modules for the fieldbus connections (master and slave) have the dimensions (W x H x D) 38 mm x 100 mm x 91 mm.

**CX1500-Bxxx**

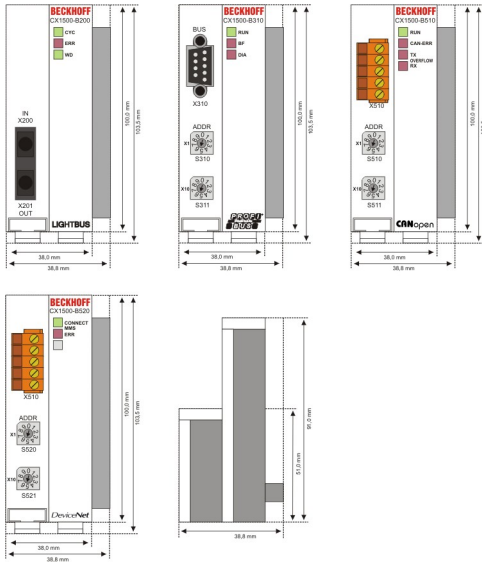

**CX1500-Mxxx**

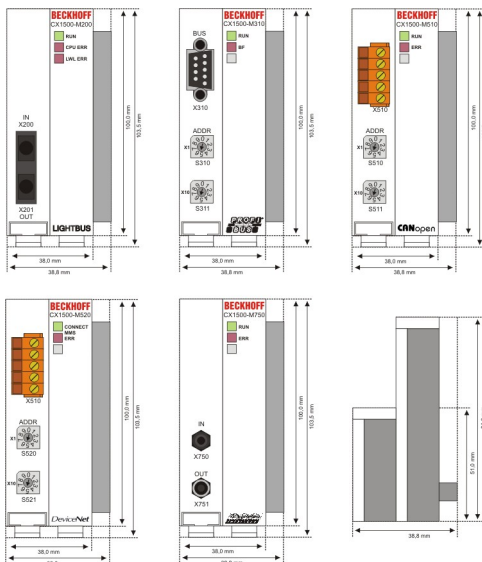

**4.1.2 Mechanical assembly of the basic module**

The installation of the modules takes place in three steps:

**1. The sequence of the modules**

The basic CPU module with system interfaces, which are factory-installed on the left side, is extended with the power supply unit on the right and with the fieldbus connection (master or slave) left side if available.

**2. Assembly of the CPU and the power supply unit**

The individual modules are simply plugged together. The PC104 connector plugs should be handled carefully in order to avoid damage. When correctly assembled, no significant gap can be seen between the attached housings.

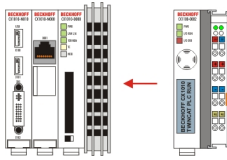

**3. Engaging on the top-hat rail**

On the bottom of the modules, there is a white tension strap, which is connected with a latching mechanism. These tension straps must be pulled down before attaching to the top-hat rail. This can be done using an ordinary screwdriver and a slight turn.

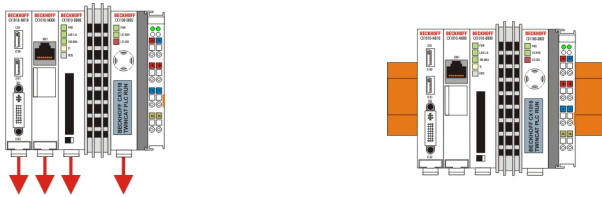

Then fix the CX1010 block on the top hat-rail using the latching straps. You should hear a soft click.

**NOTE**

Do not force the module or apply excessive pressure!

Only apply pressure at insensitive points of the housing (edges). Never apply pressure on the display, the buttons or movable parts of the CX10x0 system.

After successful latching on the top-hat rail the straps should be pushed back to their original position.

**Note:**

A locking mechanism prevents the individual housings from being pulled off again. Detailed information relating to disassembly of the CX1010 configuration from the top-hat rail can be found on page "[Removal and disposal \[► 88\]](#)".

**Installation position:**

**NOTE**

The CPU module installed on a top-hat rail may be operated only in case of ambient temperatures up to 50°C. The orientation in which the device is fitted must be selected in such a way that cooling air can flow vertically through the ventilation holes. The images show a permitted as well as the forbidden installation positions. Observe minimum clearance! Mounting must provide a clearance of 30 mm both above and below a CX1010 device combination to ensure adequate ventilation of the CPU base module and the power supply unit.

**Correct installation position:**

The high-performance CX1010 system generates a significant amount of heat, which is dissipated via a passive ventilation system. This system requires the unit to be mounted correctly. Ventilation openings are located at the top and bottom of the housing. The system therefore has to be installed horizontally. This ensures optimum air flow.

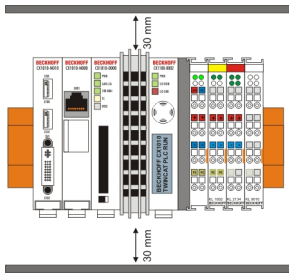

**Incorrect installation positions:**

The CX1010 system must not be operated vertically on the top-hat rail. A vertical position would lead to insufficient CPU ventilation, since the ventilation openings are located on the top and bottom of the housing. Installation of the system on its side would also lead to inadequate ventilation.

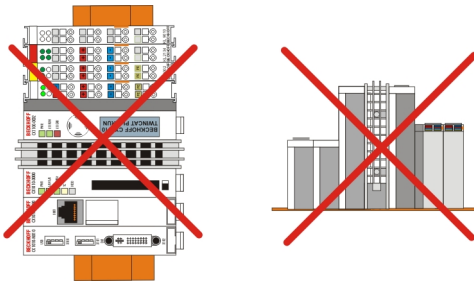

### 4.1.3 Mechanical installation of the fieldbus connection

Installation of a fieldbus connection involves several steps:

**1. Removing the cover of the basic CX1020 module**

In order to be able to connect the fieldbus to the basic CX1020 module, the cover of the basic CX1000/ CX1020 module has to be removed first. This is achieved by applying slight pressure on the cover.



**2. Assembly and connection to the CX1010 configuration**

Since the CX1000 configuration is already positioned on the top-hat rail, the assembly first has to be pushed onto the top-hat rail. To this end the latching mechanism has to be released by pulling the white straps downwards.

The assembly is connected to the existing CX1000/CX1020 configuration by simply plugging the two units together. Care must be taken that the plug of the PC104 interface is not damaged. When correctly assembled, no significant gap can be seen between the attached housings. Finally, the white straps are returned to their original position, so that the locking mechanism engages.

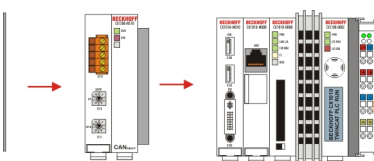



### 3. Install cover

If the connection area does not have a closing cover on the left-hand side, the cover that was previously removed should be pressed over the connections until it audibly engages.

**Note:**

If the CX1000/CX1020 configuration is not positioned on the top-hat rail, it is possible to connect the assembly with the CX1000/CX1020 configuration first and then latch the whole module onto the top-hat rail. The installation is described in section [Installation and wiring](#) [► 46].

**Note:**

A locking mechanism prevents the individual housings from being pulled off again.

## 4.2 Commissioning

### 4.2.1 Switching the PC on and off

**Switching on**

The power supply for the basic CPU module comes from the power supply unit. The basic CPU module starts automatically when the power supply unit is connected to the mains.

**Switching on for the first time**

When you switch on the PC for the first time, the pre-installed operating system (optional) will be started.

**Switching off**

The Embedded PC switches off when the power supply unit is switched off. The control software typically running on Embedded PCs should be shut down or stopped correctly. A user who may not close software may also not switch the Embedded PC off, since data can be lost from the hard disk by switching off while software is running.

Once the software has been stopped, the operating system can be shut down. Only then should the power supply be interrupted.

## 4.3 Note on using the setup

**NOTE**

Beckhoff Automation GmbH supplies the CX1020 systems pre-configured, which means they are READY FOR USE! The BIOS settings should only be modified by appropriately trained staff. Under Windows CE the BIOS should not be changed at all, since the operating system is adapted to the hardware configuration. Any change in the addresses or interrupts would lead to unstable system behaviour or even crashing.

Within the individual setup pages, F6 can be used for loading fail-safe defaults, and F7 for optimised default values for the individual setup entries. These default values are applied irrespective of whether the board was previously booted successfully with a particular setup setting. The situation is different if the defaults are called from the TOP menu. Once a setup setting that subsequently led to successful booting was saved, both menu items will load these values as defaults for the setup pages. See also "Load Fail-Safe Defaults" and "Load Optimized Defaults".

**Top menu****Phoenix – AwardBIOS CMOS Setup Utility**

▶ <a href="#">Standard CMOS Features [▶ 50]</a>	▶ <a href="#">PC Health Status [▶ 66]</a>
▶ <a href="#">Advanced BIOS Features [▶ 55]</a>	Load Fail-Save Defaults
▶ <a href="#">Advanced Chipset Features [▶ 57]</a>	Load Optimized Defaults
▶ <a href="#">Integrated Peripherals [▶ 58]</a>	Set Password
▶ <a href="#">Power Management Setup [▶ 61]</a>	Save & Exit Setup
▶ <a href="#">PnP/PCI Configuration [▶ 63]</a>	Exit Without Saving
ESC: Quit	↑ ↓ → ← Select Item
F10: Save & Exit Setup	
"Brief description of the function selected above"	

A „▶“ sign in front of the menu item indicates that a submenu is available. A „x“ sign in front of a menu item indicates that a setting option is available that first has to be activated via a higher-level setting.

**Load Fail-Save Defaults**

This option is used for absolute security settings. It is not suitable for continuous operation, but can be useful if the PC malfunctions.

**Load Optimized Defaults**

This option is used for setting optimum values as recommended by the manufacturer.

**Set Password**

Here you can enter a setup password for preventing unauthorised invoking of the BIOS.

**Save & Exit Setup**

This option is used to save the settings and exit setup. Input: Y (Please note: enter Z with German keyboard).

**Exit Without Saving**

Quit setup without saving the settings. Setting: Y (Please note: enter Z with German keyboard).

**4.3.1 Standard CMOS Features**

This menu is used for setting the date, time, hard disks, graphics mode and start-up behaviour. At the same time, information about the memory configuration determined by the system is provided. The memory configuration information cannot be changed. The setting options for date, time, graphics mode and start-up behaviour are described below. A new menu opens for setting the hard disk data.

Phoenix – AwardBIOS CMOS Setup Utility

Standard CMOS Features

Date (mm:dd:yy)	Mon, Jan 30 2006	Item	Help
Time (hh:mm:ss)	11 : 11 : 00		
▶ IDE Primary Master [▶ .52]	[ None]		
▶ IDE Primary Slave [▶ .53]	[ None]		
Halt On	[All, But Keyboard]		
Base Memory	640K		
Extended Memory	228352K		
Total Memory	229376K		

↑ ↓ → ← :Move Enter:Select +/-/PU/PD:Value F10:Save ESC:Exit [▶ .49] F1:Help

F5: Previous Values F6: Fail-Safe Defaults F7: Optimized Defaults

**Date (mm:dd:yy)**

Options:

- mm ... month
- dd ... day
- yy ... year

**Time (hh:mm:ss)**

Options:

- hh ... hours
- mm ... minutes
- ss ... seconds

**Halt On**

This parameter can be used for stopping the boot process in the event of errors. Errors may be ignored. This menu item is used to configure the settings.

Options:

- All Errors (stop for all types of error)
- No Errors (ignore all errors and continue system start-up)
- All , But Keyboard (missing keyboard is ignored)

**Base Memory**

This option is used for displaying the conventional memory (0 KB to 640 KB) in order to indicate whether it was detected by the POST.

**Extended Memory**

Available memory from the first MB to the maximum memory capacity.

**Total Memory**

This is the total of base memory, extended memory and other memory.

### 4.3.1.1 IDE Primary Master

This menu is used for setting the data of the first hard disk connected to the IDE bus as master. The hard disk data (size, number of cylinders, heads, sectors, pre-compensation and home position of the heads when the disk is switched off) are displayed automatically for the connected hard disk.

Phoenix – AwardBIOS CMOS Setup Utility

IDE Primary Master

IDE HDD Auto-Detection	[Press Enter]	Item	Help
IDE Primary Master	[Auto]		
Access Mode	[Auto]		
Capacity	0 MB		
Cylinder			
Head	0		
Precomp	0		
Landing Zone	0		
Sector	0		

↑ ↓ → ← :Move Enter:Select +/-/PU/PD:Value F10:Save ESC:Exit [▶ 50] F1:Help

F5: Previous Values F6: Fail-Safe Defaults F7: Optimized Defaults

#### IDE HDD Auto-Detection:

Automatic detection of the hard disk is initiated by pressing the <Enter> key. After a few seconds the physical data of the connected hard disk should be displayed in the lower section of the menu.

#### IDE Primary Master:

This parameter is used for configuring the IDE bus. The following options are available:

- None (no hard disk connected to this bus connection)
- Auto (auto-detection during each boot process)
- Manual (the hard disk is addressed with the set parameters)

#### Access Mode:

This option can be used to select the operating system for the hard disk. Setting options: CHS, LBA, LARGE, or Auto. Auto is the recommended setting. Normal (standard) mode supports hard disks with a capacity of up to 528 MB. This mode uses positions for data access that are specified via cylinders (CYLS), heads, and sectors. The older LBA (Logical Block Addressing) mode can support hard disks with a capacity of up to 8.4 GB. This mode uses a different method for calculating the position disk data to be accessed. It translates cylinders, heads and sectors into a logical address for the data location. Large hard disks support this mode. The BIOS supports the INT 13h extension function that enables the LBA mode to manage hard disk drives with a capacity of more than 8.4 GB. If the number of cylinders (CYLS) on the hard disk exceeds 1024 and DOS cannot support it, or if your operating system does not support LBA mode, LARGE mode should be selected. The following options are available for setting the hard disk access mode:

- CHS
- LBA
- LARGE

- Auto

The following parameters are automatically determined and displayed.

**Capacity**

Storage capacity of the hard disk. This value is calculated from the individual hard disk parameters.

**Cylinder**

Define or set the number of cylinders. Depending on the BIOS version and the manufacturer it varies between 1,024 and 16,384 cylinders.

**Head**

Define or set the number of heads. The number is between 1 and 16 heads.

**Precomp**

Write pre-compensation, required for older hard disks. This parameter specifies the cylinder from which a difference in the information density is to be expected.

**Landing Zone**

This parameter defines the so-called landing zone or park cylinder. This is the resting position for the hard disk head when the hard disk motor is switched off.

**Sector**

Define or set the number of sectors per track. Up to 63 sectors are supported, for Phoenix up to 64.

**4.3.1.2 IDE Primary Slave**

This menu is used for setting the data of the first hard disk connected to the IDE bus as master. The hard disk data (size, number of cylinders, heads, sectors, pre-compensation and home position of the heads when the disk is switched off) are displayed automatically for the connected hard disk.

Phoenix – AwardBIOS CMOS Setup Utility

IDE Primary Slave

IDE HDD Auto-Detection	[Press Enter]	Item	Help
IDE Primary Slave	[Auto]		
Access Mode	[Auto]		
Capacity	0 MB		
Cylinder			
Head	0		
Precomp	0		
Landing Zone	0		
Sector	0		

↑ ↓ → ← :Move Enter:Select +/-/PU/PD:Value F10:Save ESC:Exit [▶ 50] F1:Help

F5: Previous Values F6: Fail-Safe Defaults F7: Optimized Defaults

**IDE HDD Auto-Detection:**

Automatic detection of the hard disk is initiated by pressing the <Enter> key. After a few seconds the physical data of the connected hard disk should be displayed in the lower section of the menu.

**IDE Primary Slave:**

This parameter is used for configuring the IDE bus. The following options are available:

- None (no hard disk connected to this bus connection)
- Auto (auto-detection during each boot process)
- Manual (the hard disk is addressed with the set parameters)

**Access Mode:**

This option can be used to select the operating system for the hard disk. Setting options: CHS, LBA, LARGE, or Auto. Auto is the recommended setting. Normal (standard) mode supports hard disks with a capacity of up to 528 MB. This mode uses positions for data access that are specified via cylinders (CYLS), heads, and sectors. The older LBA (Logical Block Addressing) mode can support hard disks with a capacity of up to 8.4 GB. This mode uses a different method for calculating the position disk data to be accessed. It translates cylinders, heads and sectors into a logical address for the data location. Large hard disks support this mode. The BIOS supports the INT 13h extension function that enables the LBA mode to manage hard disk drives with a capacity of more than 8.4 GB. If the number of cylinders (CYLs) on the hard disk exceeds 1024 and DOS cannot support it, or if your operating system does not support LBA mode, LARGE mode should be selected. The following options are available for setting the hard disk access mode:

- CHS
- LBA
- LARGE
- Auto

The following parameters are automatically determined and displayed.

**Capacity**

Storage capacity of the hard disk. This value is calculated from the individual hard disk parameters.

**Cylinder**

Define or set the number of cylinders. Depending on the BIOS version and the manufacturer it varies between 1,024 and 16,384 cylinders.

**Head**

Define or set the number of heads. The number is between 1 and 16 heads.

**Precomp**

Write pre-compensation, required for older hard disks. This parameter specifies the cylinder from which a difference in the information density is to be expected.

**Landing Zone**

This parameter defines the so-called landing zone or park cylinder. This is the resting position for the hard disk head when the hard disk motor is switched off.

**Sector**

Define or set the number of sectors per track. Up to 63 sectors are supported, for Phoenix up to 64.

### 4.3.2 Advanced BIOS Features

This menu is used for setting the data of the first hard disk connected to the IDE bus as master. The hard disk data (size, number of cylinders, heads, sectors, pre-compensation and home position of the heads when the disk is switched off) are displayed automatically for the connected hard disk.

Phoenix – AwardBIOS CMOS Setup Utility

Advanced BIOS Features

Item	Value	Help
CPU Internal Cache	[Enabled]	
First Boot Device	[HDD-0]	
Second Boot Device	[USB-HDD]	
Third Boot Device	[Disabled]	
Boot Other Device	[Enabled]	
Boot Up NumLock Status	[On]	
Gate A20 Option	[Fast]	
Typematic Rate Setting	[Disabled]	
Typematic Rate (Chars/Sec)	6	
Typmatic Delay (Msec)	250	
Security Option	[Setup]	
OS Select For DRAM > 64 MB	[Non-OS2]	
Full Screen Logo	[Disabled]	

↑ ↓ → ← :Move Enter:Select +/-/PU/PD:Value F10:Save ESC:Exit [▶ 49] F1:Help

F5: Previous Values F6: Fail-Safe Defaults F7: Optimized Defaults

#### CPU Internal Cache

Here you can disable the internal CPU cache.

#### First Boot Device

Here you can specify which drive should boot first. Set the drive to be used as boot drive. Options:

- LS120 (LS-Drive)
- HDD-0 (hard disc 1)
- CDROM (CD-drive)
- HDD-1 (hard disc 2)
- ZIP100 (Zip-Drive)
- USB-FDD (USB-Floppy)
- USB-ZIP (USB Zip-Drive)
- USB-CDROM (USB CDROM)
- LAN (network)
- Disabled (disabled)

#### Second Boot Device

This setting is used for booting, if the first boot device is not available. Options:

- LS120 (LS-Drive)
- HDD-0 (hard disc 1)
- CDROM (CD-Laufwerk)
- HDD-1 (hard disc 2)
- ZIP100 (Zip-Drive)

- USB-FDD (USB-Floppy)
- USB-ZIP (USB Zip-Drive)
- USB-CDROM (USB CDROM)
- LAN (network)
- Disabled (disabled)

### **Third Boot Device**

This setting is used for booting, if the first and second boot device are not available. Options:

- LS120 (LS-Drive)
- HDD-0 (hard disc 1)
- CDROM (CD-Laufwerk)
- HDD-1 (hard disc 2)
- ZIP100 (Zip-Drive)
- USB-FDD (USB-Floppy)
- USB-ZIP (USB Zip-Drive)
- USB-CDROM (USB CDROM)
- LAN (network)
- Disabled (disabled)

### **Boot Other Device**

This option offers two choices: Enabled or Disabled. The standard setting is Enabled. The Enabled setting enables the BIOS to try all three types, i.e. "First Boot Device", "Second Boot Device" or "Third Boot Device".

### **Boot Up NumLock Status**

State of the numeric keypad. With On it is activated, with Off not.

### **Gate A20 Option**

Defines how the memory above 1MB is accessed. This should be set to Fast, in order to activate access through the chipset. With the Normal setting it is accessed via the keyboard controller. This option may speed up older computers. The first 64 K Block above 1 MB can be accessed in standard mode via address line A20. DOS will anchor itself there, if DOS=High is inserted in Config.sys.

### **Typematic Rate Setting**

This parameter is used to specify whether the options Keyboard Typematic Speed, Delay Before Keys Repeat, Typematic Rate or Typematic Delay are available. If Disabled, the values are set to 6 characters per second, with a keyboard delay of 250 ms. The settings can also be specified via the operating system.

### **Typematic Rate (Chars/Sec)**

Specifies the repetition rate of the keyboard when a key is pressed. The options are 6, 8, 10, 12, 15, 20, 24 or 30 characters/second.

### **Typmatic Delay (Msec)**

This value determines when the key function is activated after a key is pressed. The options are 250, 500, 750 or 1000 milliseconds.

### **Security Option**

This parameter specifies the option for which a password applies. If the SYSTEM option is selected, a password has to be entered during PC start-up. If the SETUP option is selected, a password is only required for accessing the BIOS.



**OS Select For DRAM > 64 MB**

For OS/2 systems with more than 64 MB RAM, option OS/2 should be used.

**Full Screen Logo**

This option can be used to specify that the start logo should fill the whole screen during booting, thereby hiding the start data. Setting options: Enabled, Disabled

**4.3.3 Advanced Chiset Features**

This menu offers the possibility to change memory settings. Be careful: wrong settings here can risk the system stability.

Phoenix – AwardBIOS CMOS Setup Utility

Advanced Chipset Features

	CPU Frequency	[AUTO]	Item	Help
X	Memory Frequency	100 MHz		
	CAS Latency	[AUTO]		
	Interleave Select	[LOI]		
	Video Memory Size	[16 M]		
	Output Display	[Panel & CRT]		
	Flat Panel Configuration	[Press Enter]		
		[Enabled]		
	Onboard Audio	[Enabled]		
	Onboard USB2.0	[Enabled]		
	Onboard IDE	[Enabled]		
	Overcurrent reporting	[Enabled]		
	Port 4 assignment	[Not used]		
	Memory Hole At 15M-16M	[Disabled]		

↑ ↓ → ← :Move Enter:Select +/-/PU/PD:Value F10:Save ESC:Exit [▶ 49] F1:Help

F5: Previous Values F6: Fail-Safe Defaults F7: Optimized Defaults

**CPU Frequency**

This option allows to set the clock frequency of the system bus. Settings are: Auto, 200 MHz, 333 MHz, 400 MHz, 433 MHz, 500 MHz.

**Memory Frequency**

This option allows to set the clock frequency of the memory. If CPU clock frequency is set to auto no options are available.

**CAS Latency**

If synchronous DRAM is installed the number of clock cycles depends on CAS timing of the DRAM. Possible settings are 2 or 3 cycles. Settings are: Auto\*, 1.5, 2.0, 2.5, 3.0 und 3.5.

**Interleave Select**

LOI / HOI

**Video Memory Size**

Disable / 8 M / 16 M (\*)

**Output Display**

Flat Panel / TV Output / CRT / Panel & CRT

**Flat Panel Configuration**

Here a menu for panel configuration can be opened (only if flat panel is selected above).

**Onboard Audio**

The onboard audio controller can be switched on or off here. Setting options: Auto, Disabled .

**Onboard USB 2.0**

The board contains a USB 2.0 chipset with support for USB 2.0. The option can be switched on or off here.

**Onboard IDE**

If this option is enabled, the IDE controller of the board can be used. If an ATAPI-CD-ROM drive is used and integrated with the secondary IDE channel, hard disk access is not slowed down.

**Over current reporting**

This option enables / disables the warning if over current occurs.

**Port 4 assignment**

Host / Device / Not Used

**Memory Hole AT 15M - 16M**

To avoid memory conflicts between system and extension cards you can reserve the area for system or extension cards.

## 4.3.4 Integrated Peripherals

This menu is used for setting the system interfaces.

Phoenix – AwardBIOS CMOS Setup Utility

Integrated Peripherals

Item	Value	Help
Master Drive PIO Mode	[Auto]	
Slave Drive PIO Mode	[Auto]	
IDE Primary Master UDMA	[Auto]	
IDE Primary Slave UDMA	[Auto]	
IDE DMA transfer access	[Enabled]	
IDE HDD Block Mode	[Enabled]	
Onboard Serial Port 1	[3E8/IRQ11]	
Onboard Serial Port 2	[2E8/IRQ10]	
UART Mode Select	[Normal]	
RxD , DxD Active	Hi, Lo	
IR Transmission Delay	Enabled	
UR2 Duplex Mode	Half	
Use IR Pins	IR-Rx2Tx2	
Watch Dog Timer Select	[Disabled]	
Onboard Serial Port 3	[3E8/IRQ11]	
Onboard Serial Port 4	[2E8/IRQ10]	
GPIO 4-5-6-7	1-1-1-1	

↑ ↓ → ← :Move Enter:Select +/-/PU/PD:Value F10:Save ESC:Exit [▶ 49] F1:Help

F5: Previous Values F6: Fail-Safe Defaults F7: Optimized Defaults

**Master PIO Mode**

PIO refers to the concept of programmed input and output. Instead of the BIOS issuing an instruction sequence for initiating a data transfer from or to the hard disk, PIO enables the BIOS to notify the controller what task should be executed. The task is then fully handled by the controller and the CPU. Your system supports five PIO modes, 0 (standard) to 4, with the main difference relating to timing. If "Auto" (automatic) is selected, the BIOS will assess your drive and automatically specify the optimum PIO mode. Auto: The BIOS automatically sets the system value depending on the timing of your hard disk drive. Mode 0-4: You can select a mode suitable mode that matches the timing your hard drive.

**Slave PIO Mode**

PIO refers to the concept of programmed input and output. Instead of the BIOS issuing an instruction sequence for initiating a data transfer from or to the hard disk, PIO enables the BIOS to notify the controller what task should be executed. The task is then fully handled by the controller and the CPU. Your system supports five PIO modes, 0 (standard) to 4, with the main difference relating to timing. If "Auto" (automatic) is selected, the BIOS will assess your drive and automatically specify the optimum PIO mode. Auto: The BIOS automatically sets the system value depending on the timing of your hard disk drive. Mode 0-4: You can select a mode suitable mode that matches the timing your hard drive.

**IDE Primary Master UDMA**

This option is used to configure the Ultra-DMA/33 mode of your hard disk. Setting options: Auto, Enabled, Disabled. The option should be set to Enabled.

**IDE Primary Slave UDMA**

This option is used to configure the Ultra-DMA/33 mode of your hard disk. Setting options: Auto, Enabled, Disabled. The option should be set to Enabled.

**IDE DMA Transfer access**

This option is used to set the DMA transfer function of the IDE-hard disk. Options are: Enabled, Disabled.

**IDE HDD Block Mode**

This option is used to activate block mode for IDE hard disks. If your drive supports this mode and this option is activated, the system will read the number of blocks per request from the configuration sector of the hard disk. The recommended setting is Enabled, although it should be noted that this is not suitable for older hard disks.

**Onboard Serial Port 1**

Configuration of the serial interface settings: IRQ11 (used for the first serial port), Disabled (no interrupt is used). Setting options: Auto, 3F8/IRQ4, 2F8/IRQ3, 3E8/IRQ4 oder 2E8/IRQ3 ..

**Onboard Serial Port 2**

Configuration of the serial interface settings: IRQ10 (used for the second serial port), Disabled (no interrupt is used). Setting options: Auto, 3F8/IRQ4, 2F8/IRQ3, 3E8/IRQ4 oder 2E8/IRQ3..

**UART Mode Select**

Mode for driver of the serial interface:

- normal for RS-232 serial interface
- ASKIR for Amplitude keyed shift interface for IR devices
- IrDA for IrDA-interface

**RxD, TxD Active**

Settings cannot be changed in standard mode. This option is used for setting IR transmission/reception to High or Low.

**IR Transmission Delay**

If this option is activated, transmission is delayed. Setting options: Enabled, Disabled.

**UR2 Duplex Mode**

This option is used for configuring infrared devices. Setting options: Full or Half. Please refer to the IR device manual regarding the duplex mode setting.

**Use IR Pins**

This option is identical to the TxD, RxD Active option. The required information can be found in the documentation for your IR device.

**Watch Dog Timer Select**

Here the timer for the watchdog will be set: Disabled, 10 Sec, 20 Sec, 30 Sec, 40 Sec, 1 Min, 2 Min, 4 Min)

**Onboard Serial Port 3**

Configuration of the serial interface settings: IRQ11 (used for the third serial port), Disabled (no interrupt is used). Setting options: Auto, 3F8/IRQ11, 2F8/IRQ11, 3E8/IRQ11 oder 2E8/IRQ11 .

**Onboard Serial Port 4**

Configuration of the serial interface settings: IRQ11 (used for the fourth serial port), Disabled (no interrupt is used). Setting options: Auto, 3F8/IRQ10, 2F8/IRQ10, 3E8/IRQ10 oder 2E8/IRQ10.

### 4.3.5 Power Management Setup

This menu is used for power management settings.

Phoenix – AwardBIOS CMOS Setup Utility

Power Management Setup

ACPI Suspend Type	[S1(POS)]	Item	Help
Power Management	[Disabled]		
** PM Timers **			
Standby Mode	Disabled		
Suspend Mode	Disabled		
HDD Power Down	[Disabled]		
Modem Use IRQ	[N/A]		
Soft-Off by PWR-BTTN	[Instant-Off]		
Power-On by Alarm	[Disabled]		
Time (hh:mm:ss) Alarm	0		
	0		
	0		
IRQ Wake Events	[Press Enter] [▶ 62]		

↑ ↓ → ← :Move Enter:Select +/-/PU/PD:Value F10:Save ESC:Exit [▶ 49] F1:Help

F5: Previous Values F6: Fail-Safe Defaults F7: Optimized Defaults

#### ACPI Suspend Type

This option offers two possibilities: S1 (POS) and S3 (STR). ACPI normally has six states: system S0, S2, S3, S4, S5. For more information see BIOS-Inside / ACPI-Funktionen.

**S1 (POS) Power on Suspend:** The sleep mode S1 has a very low reactivation latency. In this state no system context get lost (CPU oder Chipsatz)

**S3 (STR) Suspend to RAM:** The state S3 is a deeper sleep mode. It has a low reactivation latency. All system context except the memory context get lost.

#### Power Management

Settings: Disabled (no energy saving function used), Min Saving (this setting is activated after 40 minutes and offers the lowest energy saving level), Max Saving (this setting offers the highest energy saving level).

#### HDD Power Down

This setting controls how long a harddisk must be left idle before it spins down. The default is "Disabled". (Disabled, 1 / 5 / 10/ 15 30 / 45 Sec. / 1 Min )

#### Modem Use IRQ

This option is used for specifying the interrupt line (IRQ) of a modem (if present). Activity on this line causes the computer to 'wake up' in order to receive a fax, for example. Setting options: NA (no allocation), 3 (allocated), 4, 5, 7, 9, 10, 11

#### Soft-Off by PWR-BTTN

Here you can set the action of the power button: Delay 4 sec.: you have to press the power button longer than 4 sec to shut the system down. Instant-Off: PC shutdown immediately.

**Power On by Alarm**

Up to three timers can be set to restart system.

**IRQ Wake Events**

Here a menu can be opened to select the IRQs for system wakeup.

**4.3.5.1 IRQ Wakeup Events**

Here you can set the interrupts for events system wakeup if system is in suspend mode.

Phoenix – AwardBIOS CMOS Setup Utility

IRQ Wakeup Events

Item	Help
IRQ1 (Keyboard)	[OFF]
IRQ3 (COM 2)	[OFF]
IRQ4 (COM 1)	[OFF]
IRQ5 (LPT 2)	[OFF]
IRQ6 (Floppy Disk)	[OFF]
IRQ7 (LPT 1)	[OFF]
IRQ8 (RTC Alarm)	[OFF]
IRQ9 (IRQ2 Redir)	[OFF]
IRQ10 (Reserved)	[OFF]
IRQ11 (Reserved)	[OFF]
IRQ12 (PS/2 Mouse)	[OFF]
IRQ13 (Coprocessor)	[OFF]
IRQ14 (Hard Disk)	[OFF]
IRQ15 (Reserved)	[OFF]

↑ ↓ → ← :Move Enter:Select +/-/PU/PD:Value F10:Save ESC:Exit [▶ 61] F1:Help

F5: Previous Values F6: Fail-Safe Defaults F7: Optimized Defaults

**IRQ1 (Keyboard)**

[ON /OFF]

**IRQ3 (COM 2)**

[ON /OFF]

**IRQ4 (COM 1)**

[ON /OFF]

**IRQ5 (LPT 2)**

[ON /OFF]

**IRQ6 (Floppy Disk)**

[ON /OFF]

**IRQ7 (LPT 1)**

[ON /OFF]

**IRQ8 (RTC Alarm)**

[ON /OFF]

**IRQ9 (IRQ2 Redir)**

[ON /OFF]

**IRQ10 (Reserved)**

[ON /OFF]

**IRQ11 (Reserved)**

[ON /OFF]

**IRQ12 (PS/2 Mouse)**

[ON /OFF]

**IRQ13 (Coprocesor)**

[ON /OFF]

**IRQ14 (Hard Disk)**

[ON /OFF]

**IRQ15 (Reserved)**

[ON /OFF]

**4.3.6 PnP/PCI Configurations**

This menu is used for configuring the PCI bus and Plug and Play Management.

Phoenix – AwardBIOS CMOS Setup Utility

PnP/PCI Configurations

		Item	Help
PNP OS Installed	[Yes]		
Init Display First	[Onboard]		
Reset Configuration Data	[Enabled]		
Resources Controlled By	[Manual]		
▶ <u>IRQ Resources</u> [▶ 64]	[Press Enter]		
▶ <u>DMA Resources</u> [▶ 64]	[Press Enter]		
▶ <u>Memory Resources</u> [▶ 65]	[Press Enter]		
PCI/VGA Palette Snoop	[Disabled]		

↑ ↓ → ← :Move Enter:Select +/-/PU/PD:Value F10:Save ESC:Exit [▶ 49] F1:Help

F5: Previous Values F6: Fail-Safe Defaults F7: Optimized Defaults

**Init Display First**

This option selects the primary graphic card. Either a card in PCI-Slot or in AGP-Slot. Options: "First PCI" or "OnboardAGP".

**Reset Configuration Data**

If activated, the option ensures that the BIOS deletes the information relating to built-in components and their resources and reconfigures them (all settings are reset). Setting options: Enabled, Disabled.

**Resources Controlled By**

Specifies whether the PnP settings should be assigned via setup or automatically. Auto should be used, if there are no problems with IRQ or DMA assignments.

**IRQ Resources**

If these resources are set manually, each system interrupt should be assigned a type, depending on the type of device using the interrupt.

**DMA Resources**

If these resources are set manually, each DMA (0 upto 7) can be mapped to PCI/ISA PnP or Legacy ISA.

**Memory Resources**

If memory areas are to be protected for use by the operating system, an area can be set here.

**PCI/VGA Palette Snoop**

Used by multimedia video cards. This function should be switched on (Enabled), depending on the card. It is switched off by default.

**4.3.6.1 IRQ Resources**

This menu is used for disabling interrupts for free allocation to PCI slots.

Phoenix – AwardBIOS CMOS Setup Utility

IRQ Resources

IRQ-7 assigned to	[PCI Device]	Item	Help
IRQ-12 assigned to	[PCI Device]		
IRQ-15 assigned to	[PCI Device]		

↑ ↓ → ← :Move Enter:Select +/-/PU/PD:Value F10:Save ESC:Exit [▶ 63] F1:Help

F5: Previous Values F6: Fail-Safe Defaults F7: Optimized Defaults

**IRQ-n assigned to ( n = {3,4,5,7,9,10,11,12,14,15} )**

This parameter is used for disabling (reserving) an interrupt for free allocation. If the setting [PCI Device] is used, the interrupt is allocated dynamically.

**4.3.6.2 DMA Resources**

Each DMA Channel (0, 1, 3, 5, 6 und 7) can be assigned to one BUS (PCI/ISA PnP oder ISA).



Phoenix – AwardBIOS CMOS Setup Utility

DMA Resources

DMA-0 assigned to	[PCI/ISA PnP]	Item	Help
DMA-1 assigned to	[PCI/ISA PnP]		
DMA-3 assigned to	[PCI/ISA PnP]	Menu Level >	
DMA-5 assigned to	[PCI/ISA PnP]		
DMA-6 assigned to	[PCI/ISA PnP]	Legacy ISA for devices	
DMA-7 assigned to	[PCI/ISA PnP]	compliant with the	
		original PC AT bus	
		specification, PCI/ISA	
		PnP for devices	
		compliant with the	
		Plug and Play standard	
		whether designed fot	
		PCI or ISA bus	
		architecture	

↑ ↓ → ← :Move Enter:Select +/-/PU/PD:Value F10:Save ESC:Exit [▶ 63] F1:Help

F5: Previous Values F6: Fail-Safe Defaults F7: Optimized Defaults

**DMA-n assigned to ( n = {0,1,3,5,6,7} )**

The Bus for the DMA Channel can be assigned (PCI/ISA PnP oder ISA Legacy).

**4.3.6.3 Memory Resources**

This menu can be used to specify a memory area for peripherals. The area is precisely defined through a base address and length.

Phoenix – AwardBIOS CMOS Setup Utility

Memory Resources

Reserved Base	[D000]	Item	Help
Reserved Memory Length	[64K]		

↑ ↓ → ← :Move Enter:Select +/-/PU/PD:Value F10:Save ESC:Exit [▶ 63] F1:Help

F5: Previous Values F6: Fail-Safe Defaults F7: Optimized Defaults

**Reserved Base**

Start address of the reserved area. N/A (not available), D000, D400, D800 or DC00 can be selected as addresses.

**Reserved Memory Length**

Size of the memory area in KB. 8K, 16K, 32K or 64K can be set.

**4.3.7 PC Health Status**

This menu is used for displaying the settings for CPU and motherboard temperatures, power supply, and fan speed.

Phoenix – AwardBIOS CMOS Setup Utility

PC Health Status

Shutdown Temperature	[Disabled]	Item	Help
Temp. CPU	70°C		
Temp. Board	59°C		
VCORE	1.21V		
VCORESBS	1.24V		
+12 V	12.75V		
VCCMEM	2.57V		
VIO	3.39V		
+5 V	5.29V		
Fan1 Speed	0		

↑ ↓ → ← :Move Enter:Select +/-/PU/PD:Value F10:Save ESC:Exit [▶ 49] F1:Help

F5: Previous Values F6: Fail-Safe Defaults F7: Optimized Defaults

**Shutdown Temperature**

Emergency temperature system is shutting down. (60°C / 140°F, 65°C / 149°F, 70°C / 158°F, Disabled)

**Temp. CPU**

Temperature of the CPU.

The maximum operating temperature is 85°C. A warning should be given, if temperature rises higher than 85° C. If the temperature rises higher than 95° C the system should be shut down. The position of the sensors is shown in diagram below.

**Temp. Board**

Temperature sensor 1 of the system board of the CX1010. The maximum operating temperature is 80°C. A warning should be given, if temperature rises higher than 80° C. If the temperature rises higher than 85° C the system should be shut down. The position of the sensors is shown in diagram below.

**VCORE**

Operating power of the porcessor core.

**VCORSB**

Standby power of processor core.

**+12 V**

Supply voltage, 12 V.

**VCCMEM**

Power supply of memory.

**VIO**

Power supply of outputs.

**+5 V**

Supply voltage, 5 V.

**Fan1 Speed**

Rotation Fan 1 (0 though no fan connected)

## 5 Error handling and diagnostics

### 5.1 CPU basic module

#### 5.1.1 LEDs Basic CPU-Module

##### Requirements

Anzeige	LED	Bedeutung
	PWR	Power supply The Power LED comes on when the device is connected to a live power supply unit.
	LAN L/A	LAN L/A (LINK/ ACTIVITY), lights green in network is connected. Flashes green by net work activity.
	100 MBit	Network link speed 100 MBit LED lights up green.
	TC	TwinCAT Status LED TwinCAT is in Run-Mode (green) TwinCAT is in Stop-Modus (red) TwinCAT is in Config-Mode (blue)
	HDD	Read/Write Compact Flash (red) Indicates access to the CF card.

### 5.2 Power supply units

#### 5.2.1 CX1100-0001 power supply LEDs

Display	LED	Meaning
	Power	The LED lights up green when the power supply is correct, but red if there is a short circuit.

#### 5.2.2 CX1100-0002 power supply LEDs

After switching on, the power supply immediately checks the connected Bus Terminal configuration. Error-free start-up is signalled by the red "I/O ERR" LED being extinguished. If the "I/O ERR" LED blinks, an error in the area of the terminals is indicated. The error code can be determined from the frequency and number of blinks. This permits rapid rectification of the error.

Display	LED	Meaning
	Power	Power supply The LED lights up green when the power supply is correct, but red if there is a short circuit.
	I/O Run	K-Bus diagnostics The green LED lights up in order to indicate fault-free operation. "Fault-free" means that the communication with the fieldbus system is also running.
	I/O Error	K-Bus diagnostics The red LED flashes to indicate an error. The red LED blinks with two different frequencies.

Table 13: The I/O error LED blink code

Fast blinking	Start of the error code
First slow sequence	Error code
Second slow sequence	Error code argument

**LEDs for K-Bus diagnosis**

Error code	Error code argument	Description	Remedy
<b>Persistent, continuous blinking</b>		EMC problems	<ul style="list-style-type: none"> <li>- Check power supply for overvoltage or undervoltage peaks</li> <li>- Implement EMC measures</li> <li>- If a K-Bus error is present, it can be localised by a restart of the power supply (by switching it off and then on again)</li> </ul>
<b>1 pulse</b>	0	EEPROM checksum error	Revert to the manufacturer's setting
	1	Code buffer overflow	Insert fewer Bus Terminals. The programmed configuration has too many entries in the table
	2	Unknown data type	Software update required for the power supply
<b>2 pulses</b>	0	Programmed configuration has an incorrect table entry	Check programmed configuration for correctness
	n (n > 0)	Table comparison (Bus Terminal n)	Incorrect table entry
<b>3 pulses</b>	0	K-Bus command error	<ul style="list-style-type: none"> <li>- No Bus Terminal inserted</li> <li>- One of the Bus Terminals is defective; halve the number of Bus Terminals attached and check whether the error is still present with the remaining Bus Terminals. Repeat until the defective Bus Terminal is located.</li> </ul>
<b>4 pulses</b>	0	K-Bus data error, break behind the power supply	Check whether the n+1 Bus Terminal is correctly connected; replace if necessary.
	n	Break behind Bus Terminal n	Check whether the Bus End Terminal 9010 is connected.
<b>5 pulses</b>	n	K-Bus error in register communication with Bus Terminal n	Exchange the nth bus terminal
<b>9 pulses</b>	0	Checksum error in Flash program	Revert to the manufacturer's setting
	n (n>0)	Bus Terminal n is not consistent with the configuration that existed when the boot project was created	Revert to the manufacturer's setting which will clear the boot project.
<b>14 pulses</b>	n	nth Bus Terminal has the wrong format	Start the power supply again, and if the error occurs again then exchange the Bus Terminal.

Error code	Error code argument	Description	Remedy
15 pulses	n	Number of Bus Terminals is no longer correct	Start the power supply up again.
16 pulses	n	Length of the K-Bus data is no longer correct	Start the power supply up again.

### Error code argument

The number of pulses indicates the position of the last Bus Terminal before the fault. Passive Bus Terminals, such as a power feed terminal, are not included in the count.

In the case of some errors, rectification does not cause the power supply to leave the blink sequence. The power supply can only be restarted by switching its supply voltage off and on again.

### Note:

The supply voltage of the power supply unit, which is necessary to supply power to the CX1000 system, must not be interrupted in the middle of operation. Switching off the supply voltage to the power supply unit refers here to the power supply on the power contacts.

## 5.2.3 CX1100-0012 power supply LEDs

After switching on, the power supply immediately checks the connected Bus Terminal configuration. Error-free start-up is signaled by the red "I/O ERR" LED being extinguished. If the "I/O ERR" LED blinks, an error in the area of the terminals is indicated. The error code can be determined from the frequency and number of blinks. This permits rapid rectification of the error.

Display	LED	Meaning
	Power	Power supply The LED lights up green when the power supply is correct, but red if there is a short circuit.
	I/O Run	K-Bus diagnostics The green LED lights up in order to indicate fault-free operation. "Fault-free" means that the communication with the fieldbus system is also running.
	I/O Error	K-Bus diagnostics The red LED flashes to indicate an error. The red LED blinks with two different frequencies.

Table 14: The I/O error LED blink code

Fast blinking	Start of the error code
First slow sequence	Error code
Second slow sequence	Error code argument



**LEDs for K-Bus diagnosis**

Error code	Error code argument	Description	Remedy
<b>Persistent, continuous blinking</b>		EMC problems	<ul style="list-style-type: none"> <li>- Check power supply for overvoltage or undervoltage peaks</li> <li>- Implement EMC measures</li> <li>- If a K-Bus error is present, it can be localised by a restart of the power supply (by switching it off and then on again)</li> </ul>
<b>1 pulse</b>	0	EEPROM checksum error	Revert to the manufacturer's setting
	1	Code buffer overflow	Insert fewer Bus Terminals. The programmed configuration has too many entries in the table
	2	Unknown data type	Software update required for the power supply
<b>2 pulses</b>	0	Programmed configuration has an incorrect table entry	Check programmed configuration for correctness
	n (n > 0)	Table comparison (Bus Terminal n)	Incorrect table entry
<b>3 pulses</b>	0	K-Bus command error	<ul style="list-style-type: none"> <li>- No Bus Terminal inserted</li> <li>- One of the Bus Terminals is defective; halve the number of Bus Terminals attached and check whether the error is still present with the remaining Bus Terminals. Repeat until the defective Bus Terminal is located.</li> </ul>
<b>4 pulses</b>	0	K-Bus data error, break behind the power supply	Check whether the n+1 Bus Terminal is correctly connected; replace if necessary.
	n	Break behind Bus Terminal n	Check whether the Bus End Terminal 9010 is connected.
<b>5 pulses</b>	n	K-Bus error in register communication with Bus Terminal n	Exchange the nth bus terminal
<b>9 pulses</b>	0	Checksum error in Flash program	Revert to the manufacturer's setting
	n (n>0)	Bus Terminal n is not consistent with the configuration that existed when the boot project was created	Revert to the manufacturer's setting which will clear the boot project.
<b>14 pulses</b>	n	nth Bus Terminal has the wrong format	Start the power supply again, and if the error occurs again then exchange the Bus Terminal.

Error code	Error code argument	Description	Remedy
15 pulses	n	Number of Bus Terminals is no longer correct	Start the power supply up again.
16 pulses	n	Length of the K-Bus data is no longer correct	Start the power supply up again.

**Error code argument**

The number of pulses indicates the position of the last Bus Terminal before the fault. Passive Bus Terminals, such as a power feed terminal, are not included in the count.

In the case of some errors, rectification does not cause the power supply to leave the blink sequence. The power supply can only be restarted by switching its supply voltage off and on again.

**Note:**

The supply voltage of the power supply unit, which is necessary to supply power to the CX1000 system, must not be interrupted in the middle of operation. Switching off the supply voltage to the power supply unit refers here to the power supply on the power contacts.

**5.2.4 CX1100-0003 power supply LEDs**

BECKHOFF CX1100-00xx: Error handling and diagnostics

After switching on, the power supply immediately checks the connected Bus Terminal configuration. Error-free start-up is signalled by the red "I/O ERR" LED being extinguished. If the "I/O ERR" LED blinks, an error in the area of the terminals is indicated. The error code can be determined from the frequency and number of blinks. This permits rapid rectification of the error. Though the power supply supports two bus systems both bus errors are reported by the "I/O-Err" LED. An error ob K-Bus is reported by rapid blinking. One long flash (app. 2 sec.) reports errors on IP-Link-bus.

Display	LED	Meaning
	Power	Power supply The LED lights up green when the power supply is correct, but red if there is a short circuit.
	I/O Run	K-Bus diagnostics / IP-Link diagnostics The green LED lights up in order to indicate fault-free operation. "Fault-free" means that the communication with the fieldbus system is also running.
	I/O Error	K-Bus diagnostics / IP-Link diagnostics The red LED flashes to indicate an error. The red LED blinks with two different frequencies.

**LEDs for K-Bus diagnosis**

Table 15: The I/O error LED blink code

Fast blinking	Start of the error code
First slow sequence	Error code
Second slow sequence	Error code argument

*Table 16: LEDs for K-Bus diagnosis*

Error code	Error code argument	Description	Remedy
<b>Persistent, continuous blinking</b>		EMC problems	<ul style="list-style-type: none"> <li>- Check power supply for overvoltage or undervoltage peaks</li> <li>- Implement EMC measures</li> <li>- If a K-Bus error is present, it can be localised by a restart of the power supply (by switching it off and then on again)</li> </ul>
<b>1 pulse</b>	0	EEPROM checksum error	Revert to the manufacturer's setting
	1	Code buffer overflow	Insert fewer Bus Terminals. The programmed configuration has too many entries in the table
	2	Unknown data type	Software update required for the power supply
<b>2 pulses</b>	0	Programmed configuration has an incorrect table entry	Check programmed configuration for correctness
	n (n > 0)	Table comparison (Bus Terminal n)	Incorrect table entry
<b>3 pulses</b>	0	K-Bus command error	<ul style="list-style-type: none"> <li>- No Bus Terminal inserted</li> <li>- One of the Bus Terminals is defective; halve the number of Bus Terminals attached and check whether the error is still present with the remaining Bus Terminals. Repeat until the defective Bus Terminal is located.</li> </ul>
<b>4 pulses</b>	0	K-Bus data error, break behind the power supply	Check whether the n+1 Bus Terminal is correctly connected; replace if necessary.
	n	Break behind Bus Terminal n	Check whether the Bus End Terminal 9010 is connected.
<b>5 pulses</b>	n	K-Bus error in register communication with Bus Terminal n	Exchange the nth bus terminal
<b>9 pulses</b>	0	Checksum error in Flash program	Revert to the manufacturer's setting
	n (n>0)	Bus Terminal n is not consistent with the configuration that existed when the boot project was created	Revert to the manufacturer's setting which will clear the boot project.
<b>14 pulses</b>	n	nth Bus Terminal has the wrong format	Start the power supply again, and if the error occurs again then exchange the Bus Terminal.

Error code	Error code argument	Description	Remedy
15 pulses	n	Number of Bus Terminals is no longer correct	Start the power supply up again.
16 pulses	n	Length of the K-Bus data is no longer correct	Start the power supply up again.

### Error code argument

The number of pulses indicates the position of the last Bus Terminal before the fault. Passive Bus Terminals, such as a power feed terminal, are not included in the count.

In the case of some errors, rectification does not cause the power supply to leave the blink sequence. The power supply can only be restarted by switching its supply voltage off and on again.

### Note:

The supply voltage of the power supply unit, which is necessary to supply power to the CX-System, must not be interrupted in the middle of operation. Switching off the supply voltage to the power supply unit refers here to the power supply on the power contacts.

### LEDs for IP-Link-Bus-Diagnosis

After a long flash (app.. 2 sec.) an IP-Link-Bus error has occurred. The following tables describe the error codes and help to find the reason for the error. IP-Link errors most often turn out to be a result of inappropriate use of the optical fiber.

I/O Err		Description	Remedy
off		No data exchange	Module in synchronous mode or - activate Profibus cyclic data
1	0	EEPROM checksum error	Set manufacturer's setting with the KS2000 software
2		Reserved	-
3		Break location has been recognized	interruption before the master's receiver
3	n	Break location has been recognized	n-th module before the master's receiver
3	n	m	(n*10)+m-th module before the master's receiver
4		Too many faulty telegrams have been detected (more than 25%)	The optical fiber wiring in front of the nth extension module should be checked
5		Register access to complex modules has failed	Check the nth module
11		Complex module working incorrectly	Exchange the nth module
12		More than 120 modules in the ring	Connect fewer modules
13		nth module unknown	Firmware update required
off		Module is exchanging data	no error



If an error occurs on both terminal busses (K-Bus and IP-Link-Bus) the error on K-Bus is reported at first. The IP-Link-Bus error is reported as second. Both error codes are introduced by their typical blink signal.

### 5.2.5 CX1100-0013 power supply LEDs

BECKHOFF CX1100-00xx: Error handling and diagnostics

After switching on, the power supply immediately checks the connected Bus Terminal configuration. Error-free start-up is signaled by the red "I/O ERR" LED being extinguished. If the "I/O ERR" LED blinks, an error in the area of the terminals is indicated. The error code can be determined from the frequency and number of blinks. This permits rapid rectification of the error. Though the power supply supports two bus systems both bus errors are reported by the "I/O-Err" LED. An error ob K-Bus is reported by rapid blinking. One long flash (app. 2 sec.) reports errors on IP-Link-bus.

Display	LED	Meaning
	Power	Power supply The LED lights up green when the power supply is correct, but red if there is a short circuit.
	I/O Run	K-Bus diagnostics / IP-Link diagnostics The green LED lights up in order to indicate fault-free operation. "Fault-free" means that the communication with the fieldbus system is also running.
	I/O Error	K-Bus diagnostics / IP-Link diagnostics The red LED flashes to indicate an error. The red LED blinks with two different frequencies.

### LEDs for K-Bus diagnosis

Table 17: The I/O error LED blink code

Fast blinking	Start of the error code
First slow sequence	Error code
Second slow sequence	Error code argument



*Table 18: LEDs for K-Bus diagnosis*

Error code	Error code argument	Description	Remedy
<b>Persistent, continuous blinking</b>		EMC problems	<ul style="list-style-type: none"> <li>- Check power supply for overvoltage or undervoltage peaks</li> <li>- Implement EMC measures</li> <li>- If a K-Bus error is present, it can be localised by a restart of the power supply (by switching it off and then on again)</li> </ul>
<b>1 pulse</b>	0	EEPROM checksum error	Revert to the manufacturer's setting
	1	Code buffer overflow	Insert fewer Bus Terminals. The programmed configuration has too many entries in the table
	2	Unknown data type	Software update required for the power supply
<b>2 pulses</b>	0	Programmed configuration has an incorrect table entry	Check programmed configuration for correctness
	n (n > 0)	Table comparison (Bus Terminal n)	Incorrect table entry
<b>3 pulses</b>	0	K-Bus command error	<ul style="list-style-type: none"> <li>- No Bus Terminal inserted</li> <li>- One of the Bus Terminals is defective; halve the number of Bus Terminals attached and check whether the error is still present with the remaining Bus Terminals. Repeat until the defective Bus Terminal is located.</li> </ul>
<b>4 pulses</b>	0	K-Bus data error, break behind the power supply	Check whether the n+1 Bus Terminal is correctly connected; replace if necessary.
	n	Break behind Bus Terminal n	Check whether the Bus End Terminal 9010 is connected.
<b>5 pulses</b>	n	K-Bus error in register communication with Bus Terminal n	Exchange the nth bus terminal
<b>9 pulses</b>	0	Checksum error in Flash program	Revert to the manufacturer's setting
	n (n>0)	Bus Terminal n is not consistent with the configuration that existed when the boot project was created	Revert to the manufacturer's setting which will clear the boot project.
<b>14 pulses</b>	n	nth Bus Terminal has the wrong format	Start the power supply again, and if the error occurs again then exchange the Bus Terminal.

Error code	Error code argument	Description	Remedy
15 pulses	n	Number of Bus Terminals is no longer correct	Start the power supply up again.
16 pulses	n	Length of the K-Bus data is no longer correct	Start the power supply up again.

### Error code argument

The number of pulses indicates the position of the last Bus Terminal before the fault. Passive Bus Terminals, such as a power feed terminal, are not included in the count.

In the case of some errors, rectification does not cause the power supply to leave the blink sequence. The power supply can only be restarted by switching its supply voltage off and on again.

### Note:

The supply voltage of the power supply unit, which is necessary to supply power to the CX-System, must not be interrupted in the middle of operation. Switching off the supply voltage to the power supply unit refers here to the power supply on the power contacts.

### LEDs for IP-Link-Bus-Diagnosis

After a long flash (app.. 2 sec.) an IP-Link-Bus error has occurred. The following tables describe the error codes and help to find the reason for the error. IP-Link errors most often turn out to be a result of inappropriate use of the optical fiber.

I/O Err		Description	Remedy
off		No data exchange	Module in synchronous mode or - activate Profibus cyclic data
1	0	EEPROM checksum error	Set manufacturer's setting with the KS2000 software
2		Reserved	-
3		Break location has been recognized	interruption before the master's receiver
3	n	Break location has been recognized	n-th module before the master's receiver
3	n	m	(n*10)+m-th module before the master's receiver
4	n	Too many faulty telegrams have been detected (more than 25%)	The optical fiber wiring in front of the nth extension module should be checked
5	n	Register access to complex modules has failed	Check the nth module
11	n	Complex module working incorrectly	Exchange the nth module
12	n	More than 120 modules in the ring	Connect fewer modules
13	n	nth module unknown	Firmware update required
off		Module is exchanging data	no error



If an error occurs on both terminal busses (K-Bus and IP-Link-Bus) the error on K-Bus is reported at first. The IP-Link-Bus error is reported as second. Both error codes are introduced by their typical blink signal.

### 5.2.6 CX1100-0004 power supply LEDs

Display	LED	Meaning	
	PWR	power supply The LED lights up green when the power supply is correct, but red if there is a short circuit.	
	L/A	off	E-Bus is not connected
		on	E-Bus is connected / no data traffic on E-bus
		blink	E-Bus is connected / data traffic on E-bus
	RUN	off	INIT
		blink	PRE-OPERATIONAL (frequency: 200 ms on / 200 ms off)
		single flash	SAVE-OPERATIONAL (frequency: 200 ms on / 1000ms off)
		on	OPERATIONAL
		flickering	BOOTSTRAP (frequency: 50 ms on / 50 ms off)
		double flash	reserved for future use (frequency: 200 ms on / 200 ms off / 200 ms on / 1000 ms off)
		triple flash	reserved for future use (frequency: 200 ms on / 200 ms off / 200 ms on / 200 ms off / 200 ms on / 1000 ms off)
		quadruple flash	reserved for future use (frequency: 200 ms on / 200 ms off / 200 ms on / 200 ms off / 200 ms on / 200 ms off / 200 ms on / 1000 ms off)

The functions for L/A and RUN LED are available in hardware revision > 2.0. The LEDs have no function in older revisions.

## 5.2.7 CX1100-0014 power supply LEDs

Display	LED	Meaning	
	PWR	power supply The LED lights up green when the power supply is correct, but red if there is a short circuit.	
	L/A	off	E-Bus is not connected
		on	E-Bus is connected / no data traffic on E-bus
		blink	E-Bus is connected / data traffic on E-bus
	RUN	off	Indicates the state of the EtherCAT bus: INIT
		blink	PRE-OPERATIONAL (frequency: 200 ms on / 200 ms off)
		single flash	SAVE-OPERATIONAL (frequency: 200 ms on / 1000ms off)
		on	OPERATIONAL
		flickering	BOOTSTRAP (frequency: 50 ms on / 50 ms off)
		double flash	reserved for future use (frequency: 200 ms on / 200 ms off / 200 ms on / 1000 ms off)
		triple flash	reserved for future use (frequency: 200 ms on / 200 ms off / 200 ms on / 200 ms off / 200 ms on / 1000 ms off)
		quadruple flash	reserved for future use (frequency: 200 ms on / 200 ms off / 200 ms on / 200 ms off / 200 ms on / 1000 ms off)

The functions for L/A and RUN LED are available in hardware revision > 2.0. The LEDs have no function in older revisions.

## 5.3 Faults

Please also refer to the Safety instructions section.

### Possible faults and their correction

If servicing is required, please quote the project number of your PC (on the type plate).

Please contact your Beckhoff branch office or representative for [local support and service](#) on Beckhoff products!

The addresses of Beckhoff's branch offices and representatives round the world can be found on her internet pages:

<http://www.beckhoff.com>

You will also find further documentation for Beckhoff components there.

Fault	Cause	Measures
no function after the Embedded PC has been switched on	no power supply  other causes	1. Check fuse 2. Measure voltage at connection, check connector pin assignment. Call Beckhoff support
Embedded PC does not boot fully	Hard disk damaged (e.g. due to switching off while software is running), incorrect setup, other causes	Check setup. Call your Beckhoff support
Computer boots, software starts, but control does not operate correctly	Cause of the fault is either in the software or in parts of the plant outside the Embedded PC.	Call the manufacturer of the machine or the software.
CF card access error	faulty CF card, faulty CF slot	Use a different CF card to check the CF slot Call your local Beckhoff support
Embedded PC only works partially or temporarily	Defective components in the Embedded PC	Call your local Beckhoff support

## 6 Removal and disposal

### 6.1 Removal and disposal

A CX10x0 hardware configuration is dismantled in 2 stages:

#### 0. Switching off and disconnecting the power supply

Before a CX10x0 system can be dismantled, the system should be switched off, and the power supply should be disconnected.

#### 1. Removing from the top-hat rail:

Before the individual CX10x0 modules are disconnected, the whole CX1020 hardware block should be removed from the top-hat rail. Proceed as follows:

##### 1.1. Release and remove the first Terminal next to the power supply unit on the top-hat rail.

First remove any wiring from power supply unit *and* then from the first terminal on the top-hat rail next to the power supply unit. If the wiring is to be reused for another system, it is advisable to make a note of the connections. Then pull the orange terminal release (see arrow) to release the terminal and pull it out.

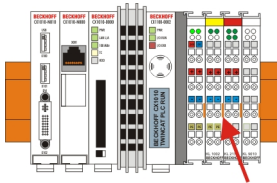

##### 1.2. Releasing the CX10x0 system

In order to release the CX10x0 block, pull the white straps at the bottom of the module in the direction of the arrows. They will lock in the extended position. After pulling the terminal release of the power supply unit, the block can be removed *carefully* from the top-hat rail.

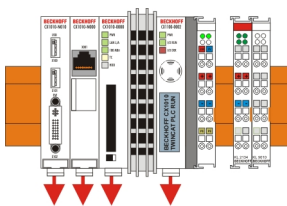

#### 2. Separating the individual modules

##### 2.1. Separating the power supply unit, the CX10x0 CPU and other components

Place the CX10x0 block onto a suitable support with the front facing down. Then insert a flat screwdriver with dimensions 1.0 x 5.5 x 150 mm into the locking mechanism, and then operating the slider by turning it about 90 degrees. The locking mechanism on the rear affects an approx. 2-3 mm wide clearance of the module latching mechanism, pushing them apart. The plug connectors of the PC 104 interface can then be pulled apart carefully.



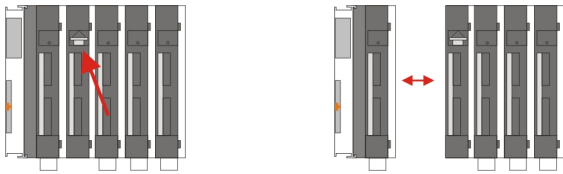

Only modules (CPU, fieldbus connections and UPS modules) that can be separated non-destructively feature a release device. Modules that cannot be separated only feature a marking point (with or without red paint seal). Applying force to these elements will destroy them.

### NOTE

Forcibly opening the module housing (e.g. removing the cover) will destroy the housing.

### Disposal

The device must be fully dismantled in order to dispose of it.

Electronic parts must be disposed of in accordance with national electronics scrap regulations.

## 7 Appendix

### 7.1 Accessories

Table 19: Compact flash cards

order number	Description
CX1900-0023	1 GByte compact flash card type I
CX1900-0025	2 GByte compact flash card type I
CX1900-0027	4 GByte compact flash card type I

Table 20: Connectors and Adaptors

order number	Description
CX1900-0101	<p>DVI-to-VGA passive Adaptor for connecting a standard desktop VGA monitor to the CX1000 system</p> <ul style="list-style-type: none"> <li>– singles out the VGA signals of the DVI-I interface of the CX1000-N001 module</li> <li>– 29-pin male DVI-A connector (bottom) to 15-pin female connector (top)</li> <li>– weight approx. 40 g</li> <li>– dimensions (W x H x D) 40 x 42 x 15 mm</li> </ul>

Table 21: Labelling Tags

order number	Description
CX1900-0200	<p>Universal plastic labels for the CX1000 system (package contains 1000 labels)</p> <ul style="list-style-type: none"> <li>– snaps into the premoulded spots on the CX1000 components</li> <li>– labelling can be done with a X-Y plotter</li> <li>– dimension of the single label 15 x 5 mm</li> <li>– material: white coloured plastic</li> <li>– Murrplastik type KMR 5/15, order number 86401014</li> </ul>

### 7.2 Certifications

All products of the Embedded PC family are CE, UL and GOST-R certified. Since the product family is continuously developed further, we are unable to provide a full listing here. The current list of certified products can be found on the [Embedded PC certificates](#) web page or at [www.beckhoff.com](http://www.beckhoff.com) under Embedded PC.

## 7.3 Support and Service

Beckhoff and their partners around the world offer comprehensive support and service, making available fast and competent assistance with all questions related to Beckhoff products and system solutions.

### Beckhoff's branch offices and representatives

Please contact your Beckhoff branch office or representative for local support and service on Beckhoff products!

The addresses of Beckhoff's branch offices and representatives round the world can be found on her internet pages:

<http://www.beckhoff.com>

You will also find further documentation for Beckhoff components there.

### Beckhoff Headquarters

Beckhoff Automation GmbH & Co. KG

Huelshorstweg 20  
33415 Verl  
Germany

Phone:	+49(0)5246/963-0
Fax:	+49(0)5246/963-198
e-mail:	info@beckhoff.com

### Beckhoff Support

Support offers you comprehensive technical assistance, helping you not only with the application of individual Beckhoff products, but also with other, wide-ranging services:

- support
- design, programming and commissioning of complex automation systems
- and extensive training program for Beckhoff system components

Hotline:	+49(0)5246/963-157
Fax:	+49(0)5246/963-9157
e-mail:	support@beckhoff.com

### Beckhoff Service

The Beckhoff Service Center supports you in all matters of after-sales service:

- on-site service
- repair service
- spare parts service
- hotline service

Hotline:	+49(0)5246/963-460
Fax:	+49(0)5246/963-479
e-mail:	service@beckhoff.com



Beckhoff Automation GmbH & Co. KG  
Hülshorstweg 20  
33415 Verl  
Germany  
Phone: +49 5246 9630  
[info@beckhoff.com](mailto:info@beckhoff.com)  
[www.beckhoff.com](http://www.beckhoff.com)